

AUTROL®

DOC. NO. : C3200-E05A



Smart Pressure Transmitter

for Gauge and Absolute Pressure Measurement

MODEL

APT3200



Duon System Co.,Ltd.
www.autrol.com

AUTROL®, AUTROL™ are trade mark of smart transmitter brand series to measure Pressure, Temperature and Level, which is manufactured & owned by DUON System Co., Ltd(hereafter DUON) since 1989. AUTROL®, AUTROL™ series also provide services of electric appliance installation, repair of electric, magnetic measuring instruments, electric appliance repair, repair of instruments and appliances for measuring and testing, repair of computer hardware, repair of electronic application machines and apparatus, repair of instruments and appliances for rotating, repair of electric power distribution machines and apparatus, repair of control machines and apparatus, computer hardware maintenance and administration, computer hardware installation. APT3500-Differential and high accuracy pressure Transmitter APT3100-Differential pressure Transmitter, APT3200-Gauge & Absolute pressure Transmitter, APT2100-Temperature Transmitter, A1100-Field Indicator.

APT3200



Standard



Flush Mount



SST Housing

Description of Product

The APT3200 Smart Pressure Transmitter is a micro processor-based high performance transmitter, which has flexible pressure calibration and output, automatic compensation of ambient temperature and process variable, configuration of various parameters, communication with HART protocol. All Data of Sensor (Tag No., type, range etc.) is to be input, modified and stored in EEPROM.

Function

- » Flexible Sensor Input : GP, AP, Flush Mount
- » Various Output : 4 ~ 20mA, Digital Signals
- » Setting Various Parameters : Zero/Span, Trim, Unit, Fail-mode, etc.
- » Self Diagnostic Function : Sensor, Memory A/D Converter, Power, etc.
- » Digital Communication with HART protocol
- » Explosion-proof Approval & Intrinsic Safety Approval : ATEX, FM, FM Canada, GOST, KCs, etc.
- » Marine Certificate : ABS, LR, BV, DNV

Functional Block Diagram

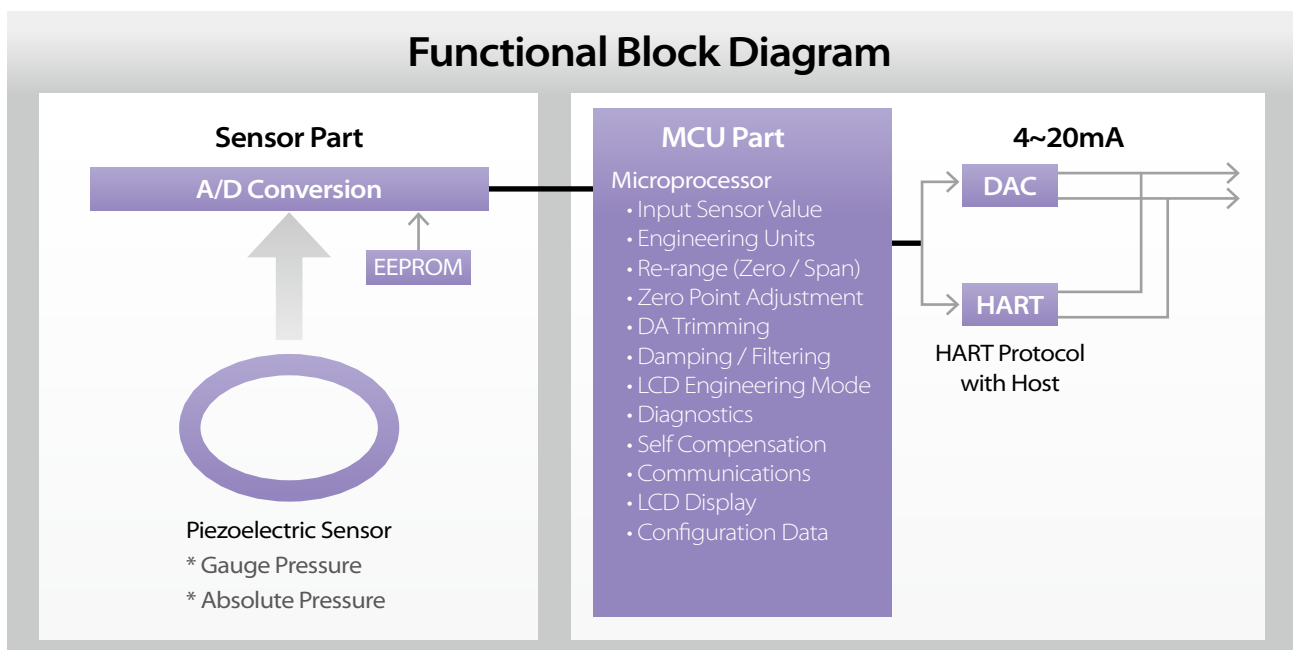

Features

- » **Superior Performance**
 - High Accuracy : $\pm 0.075\%$ of Calibrated Span
(option : $\pm 0.04\%$ of Calibrated Span)
 - Long-Term Stability
 - High Rangeability (100:1)
- » **Flexibility**
 - Measuring GP, AP
 - Data Configuration with HART configurator
- » **Reliability**
 - Continuous Self-Diagnostic Function
 - Automatic Ambient Temperature Compensation
 - Fail-mode Process Function
 - EEPROM Write Protection
 - CE EMC Conformity Standards
(EN50081-2, EN50082-2)

Transmitter Description

ATP3200 Pressure transmitter can be easily configured from any host that support the HART protocol.

- » **Basic Setup**
 - Operational Parameters.
 - 4~20mA Points (Zero/Span)
 - Damping Time : 0.25 ~ 60 sec
 - Tag : 8 alphanumeric characters
 - Descriptor : 16 characters
 - Message : 32 characters.
 - Date : day/month/year
- » **Calibration and Trimming**
 - Lower/Upper Range (zero/span)
 - Sensor Zero Trimming
 - Zero Point Adjustment
 - DAC Output Trimming
 - Transfer Function
 - Self-Compensation
- » **Self-Diagnosis and Others**
 - CPU & Analog Module Fault Detection
 - Communication Error
 - Fail-mode Handling
 - LCD Indication
 - Temperature Measurement of Sensor Module

Function

- » **Range and Sensor Limits**
 - Refer to Table 1.
- » **Zero and Span Adjustment Limits**
 - Zero and span values can be set anywhere within the range limits stated in Table 1.
 - Span must be greater than or equal to the minimum span stated in Table 1.
- » **Output (Analog Current and Digital Data)**
 - LCD Display & ENG Mode
 - Two wire 4~20mA user-configurable for linear. digital process value superimposed on 4~20mA signal, available to any host that conforms to the HART protocol
- » **Power Supply & Load Requirement**
 - External power supply required.
 - * 250 ohm load – 17.5 Vdc
 - * up to a 550 ohm load – 24 Vdc
 - Max. Loop Resistance = $(E - 12) / 0.022$
(E = Power Supply Voltage)
 - Voltage Range : 12 to 45 Vdc
 - Voltage Rating : 24 Vdc $\pm 30\%$
 - Loop Load
 - 0 ~ 1500 ohm – Operation
 - 250 ~ 550 ohm – HART Communications
- » **EMC Conformity Standards**
 - EMI (Emission) – EN50081-2:1993
 - EMS (Immunity) – EN50082-2:1995
- » **Failure Mode**
 - Fail High : Current ≥ 21.1 mA
 - Fail Low : Current ≤ 3.78 mA
- » **Storage Temperature**
 - -40°C to 85°C (without condensing)
- » **Process Temperature Limits**
 - (Range codes and approval codes may effect limits)
 - -40°C to 120°C (-104 to 248°F)
- » **Isolation**
 - Input/output isolated to 500Vrms (707 Vdc)
- » **Working Pressure Limits (silicone oil)**
 - Model G
 - 100 ~ 300KPa - # 3
 - 100 ~ 3000 KPa - # 4
 - 0 ~ 10,500KPa - # 5
 - 0 ~ 40,000 KPa - # 6
 - 0 ~ 75,000 KPa - # 7
 - Model A
 - 0 ~ 525 KPa - # 4
 - 0 ~ 3000 KPa - # 5
 - 0 ~ 5250 KPa - # 6

Physical Specifications

» Wetted Materials

- Isolating Diaphragms : 316L SST, Tantalum, HAST-C

» Non-wetted materials

- Fill Fluid : Silicone oil (DC200)
- Electronics Housing : Aluminum, SST316L(option)
Flameproof and Waterproof (IP67)
- Cover O-ring : Buna-N
- Paint : Epoxy-Polyester or Polyurethane
- Mounting Bracket : 304SST with U-bolt (304SST) for 2-inch pipe
- Nameplate : 304 SST

» Process Connections

- 1/2-14 NPT Female • 1/4-18 NPT (option)

» Electrical connections

- 1/2-14 NPT conduit with M4 Screw Terminals

» Weight

- 1.7 kg (Standard - excluding options)
- 2.83kg (SST Housing- excluding options)

Hazardous Location Certifications (option)

» KOSHA Approvals K1 Code :

* KOSHA: Korea Occupational Safety & Health Agency
 Flameproof for Class I, Zone 1 : Ex d IIC T6, IP67
 Ambient Temperature : -20 to 60°C
 Max. Process Temperature : 80°C
 Power Supply : Max. 45 Vdc
 Output : 4 to 20 mA + HART, Max. 22 mA

» ATEX Approvals E1 Code :

CE 0344 II 2 G Ex d IIC T6, T5 or T4
 Operating Temperature: -20°C ≤ Tamb ≤ +60°C
 T6 for process ≤ 85°C ; T5 for process ≤ 100°C
 T4 ≤ 130°C
 APT3200 ATEX Certification is according to the below
 Standards : EN 60079-0 : 2006 EN 60079-1 : 2007

» ATEX Certification E2 Code :

Intrinsic Safety: Ex ia T5 or T4
 Ambient Temperature : -40 to 80°C for T4, -30 to 40°C for T5
 Ui=30Vdc, Ii=200mA, Pi=0.9W, Ci=27nF, Li=104µH
 Standards: EN 60079-0 : 2009, EN60079-11 : 2007, EN60079-26 : 2007

» FM & FM Canada Approvals F1 Code :

* FM: Factory Mutual explosion proof
 * FM Canada: Canadian requirements
 Explosion proof for Class I, Division 1
 Groups A, B, C and D
 Dust-ignition proof for Class II, Division 1,
 Groups E, F and G
 Dust-ignition proof for Class II, Division 1
 "T6, see instruction for temperature code if process
 temperature above 85°C"
 Ambient Temperature : -20 to 60°C
 Enclosure: indoors and outdoors, NEMA Type 4X
 Conduit seal required within 18" for Group A only.
 Nonincendive for Class I, Division 2, Groups A, B, C & D;
 Class II, Division 2, Groups E, F & G; and Class III, Division 1,
 Temperature Code T4
 Ambient Temperature : -20 to 60°C
 Enclosure: indoors and outdoors, NEMA Type 4X

Function

» Change main parameter by Button

- Change Unit
- Change Upper range value
- Change Lower range value
- Change the Damping Second
- Select the Decimal Place
- Zero Trim
- Zero Adjustment

» 5 Digit LCD

- Express all pressure unit.
- Use 5 digit.
- Select decimal place (0 to 4)

» User define unit function

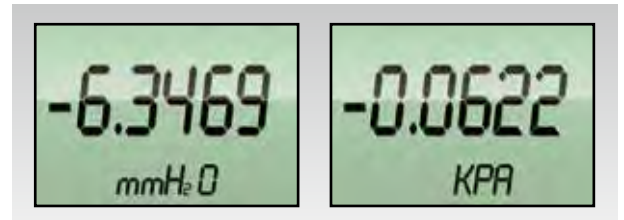

Moving within Menu : Zero
 Moving to below Menu : Span
 Moving Top Menu : Zero+Span

» Button Manu tree

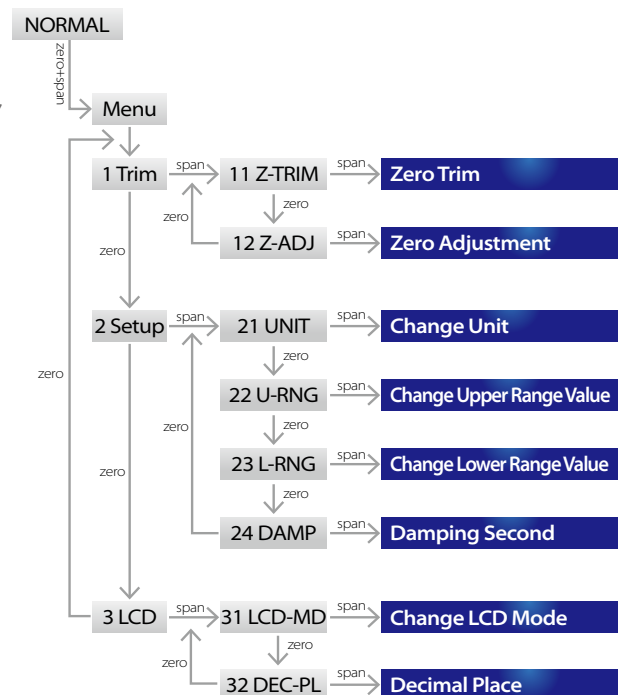

Connection Diagram of Signal, Power, HHT for Transmitter

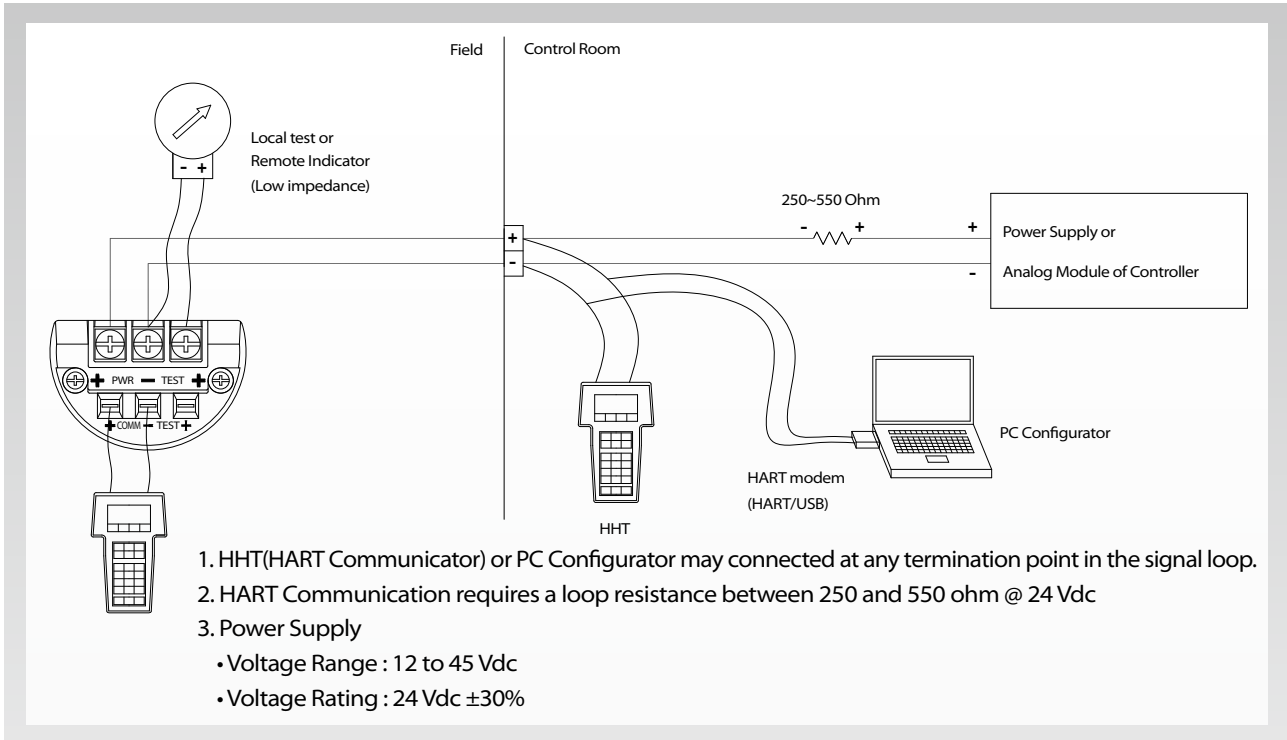

Exploded drawing of APT3200

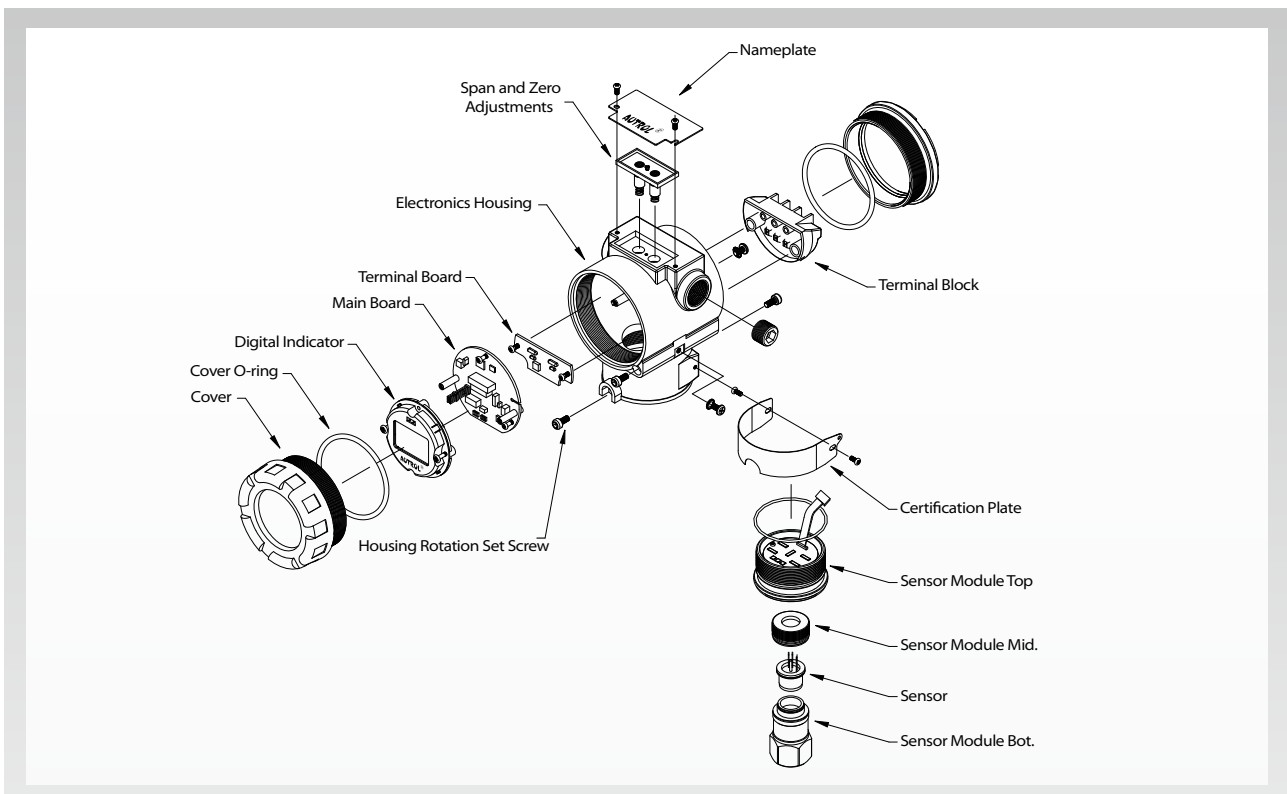

General Specifications

1. APT3200 – G/APressure Sensor Range (Rangeability = 100 : 1)

	APT3200 – G		APT3200 - A	
	Range (KPa)	Calibrated Span (KPa)	Range	Calibrated Span (KPa)
3	-100~150	1.5~150	NA	NA
4	-100 ~ 1,500	15 ~ 1,500	0 ~ 250	2.5 ~ 250
5	0 ~ 5,000	50 ~ 5,000	0 ~ 1,500	15 ~ 1,500
6	0 ~ 25,000	250 ~ 25,000	0 ~ 2,500	25 ~ 2,500
7	0 ~ 60,000	600 ~ 60,000	NA	NA

2. Electrical Specifications

Power Supply	Voltage Range : 12 to 45 Vdc Voltage Rating : 24 Vdc \pm 30%	Output Signal	4 ~ 20 mA dc / HART
HART Loop Resistance	250 ~ 550 ohm	Isolation	500 Vrms (707 Vdc)

3. Performance Specifications

Reference Accuracy	$\pm 0.075\%$ of Span ($0.1 \text{ URL} \leq \text{Span} \leq \text{URL}$) $\pm [0.025 + 0.005 \times (\text{URL}/\text{Span})]\%$ of Span ($0.01 \text{ URL} \leq \text{Span} < 0.1 \text{ URL}$)	Ambient Temperature	$-40^{\circ}\text{C} \sim +85^{\circ}\text{C}$
		LCD Meter Ambient Temp	$-30^{\circ}\text{C} \sim +80^{\circ}\text{C}$
		Humidity Limits	5% ~ 100% RH
Ambient Temp. Effect	$\pm [0.019\% \text{ URL} + 0.125\% \text{ Span}] / 28^{\circ}\text{C}$	Process Temp. Limit	$-40^{\circ}\text{C} \sim +120^{\circ}\text{C}$
		Power Supply Effect	$\pm 0.005\%$ of Span per Volt
		Stability	$\pm [0.125\% \text{ URL}]$ for 36 months

4. Physical Specifications

Isolating Diaphragm	316L SST	Process Connection Size	1/2 – 14 NPT Female
Electronic Housing	Aluminum	Electrical Connections	1/2 – 14 NPT with M4
Housing Class	Waterproof (IP67)	2" Pipe Stanchion Type Bracket	Angle or Flat type
		Weight (excluding options)	1.7 kg (standard) 2.83kg(SST Housing)

Ordering Information

MODEL	Code	Description				
APT3200	-G	Gauge Pressure Transmitter (reference accuracy : 0.075 % of span)				
	-F	Flush Mount Pressure Transmitter				
	-A	Absolute Pressure Transmitter (reference accuracy : 0.075 % of span)				
Range		G/F		A		
		Range (KPa)	Min.Span (KPa)	Range (KPa)	Min. Span (KPa)	
	3	-100~150	1.5	NA	NA	
	4	-100 ~ 1,500	15	0 ~ 250	2.5	
	5	0 ~ 5,000	50	0 ~ 1500	15	
	6	0 ~ 25,000	250	0 ~ 2500	25	
	7	0 ~ 60,000	600	NA	NA	
	X	Special				
Mounting Flange Material		DIAPHRAGM		OTHER		
	M11	316L SST		316 SST		
	*M12	HAST-C		316 SST		
	*M13	Tantalum		316 SST		
	*M21	HAST - C		HAST-C		
Hazardous Location Certifications	K0	Maker Standard (Waterproof : IP67)				
	K1	KCs Flameproof Approval		*K2	KCs Intrinsic Safety Approval	
	E1	ATEX (KEMA) Exopion proof		E2	ATEX(KEMA) Intrinsic Safety	
	F1	FM & FM Canada Explosion proof		*F2	FM & FM Canada Intrinsic Safety	
Fill Fluid	1	Silicone (DC 200)				
	*2	Inert fill (Halocarbon Oil)				
Process Connection	S	1/2 – 14 NPT Female (standard)				
	O	1/4 - 18 NPT Female (adapter)				
	X	Special				
Electrical Connection	1	1/2-14NPT	Epoxy-Polyester Painted Aluminum			
	2	G1/2	Epoxy-Polyester Painted Aluminum (Adapter)			
	X	Special				
Option	M1	LCD Indicator				
	LPI	Lightning Protector (Internal)		LPE	Lightning Protector (External)	
	K	Oil Free Finish				
	2W	2 way manifold Remote type				
	BA	Stainless Steel Bracket (Angle type) with SST Bolts				
	BF	Stainless Steel Bracket (Flat type) with SST Bolts				
	ST	Stainless Steel Housing				
	X	Special				

Example : APT3200-G5-M11-K0-1-S-1-M1

Note 1 : Request to manufacturer for Draft Range, Absolute (small pressure and vacuum) and Items marked " * " before order.

Dimensions of Transmitter (mm)

Standard Model

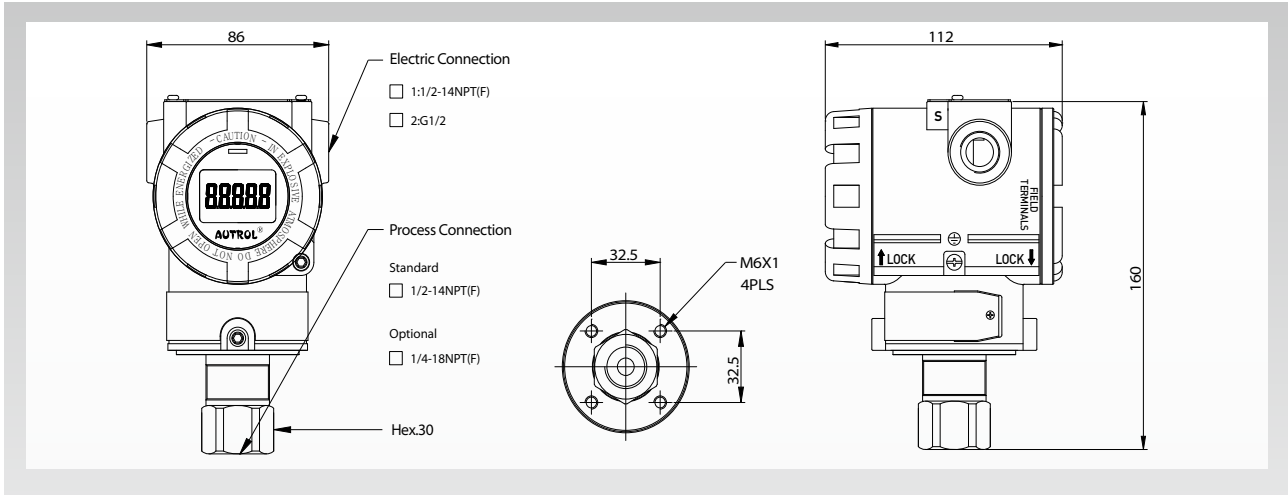

Flush Mount Model

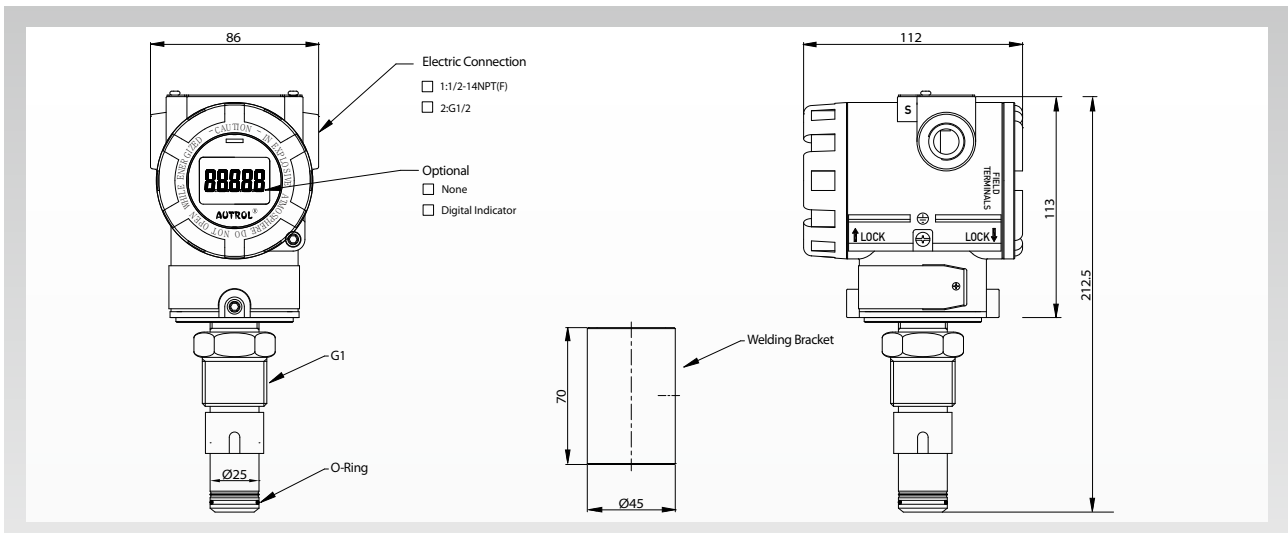

Intrinsically Safe Model

