

Instruction handbook

Language **English**
Translation
Document No. 5.12008.14
Part No. 444496
Status 07-Jul-2021

be in motion **be in motion**



BAUMÜLLER

b maXX 4000

BM4400, BM4400 ES
BM4600, BM4600 ES
BM4700, BM4700 ES

**Basic Units/
Power modules
with Servo Controller**

E	5.12008.14
----------	------------

Read the Instruction handbook before starting any work!

Copyright This Instruction handbook may be copied by the owner in any quantity, but only for internal use. This Instruction handbook may not be copied or reproduced, in whole or in part, for any other purposes.
The use and disclosure of information contained in this Instruction handbook are not permitted.
Designations and company marks contained in these Instruction handbook could be trademarks, the use of which by third parties for their own purposes could violate the rights of the rights holder.

Preliminary information

Warning Insofar as this document is identified as being preliminary information, the following applies:

This version is regarded as providing advance technical information to users of the described devices and their functions at an early enough time in order to adapt to any possible changes or expanded functionality.

This information must be regarded as being preliminary, as it has not yet passed through Baumüller's internal review process. In particular, this information is still subject to changes, thus no legal liability can be derived from this preliminary information. Baumüller assumes no liability for damages that might arise from this possibly faulty or incomplete version.

If you detect or suspect any content errors and/or major form errors in this preliminary information, we request that you notify the Baumüller support specialist responsible for you. Please provide us, via this employee, with your insights and comments so that we can take them into account and include them when transitioning from the preliminary information to the final information (as reviewed by Baumüller).

The conditions stipulated in the following section under „Obligatory“ are invalid in case of preliminary information.

Obligatory

This Instruction handbook are a part of the equipment/machine. This Instruction handbook must be available to the operator at all times and must be in legible condition. If the equipment/machine is sold or moved to another location, these Instruction handbook must be passed on by the owner together with the equipment/machine.

After any sale of the equipment/machine, this original and all copies must be handed over to the buyer. After disposal or any other end use, this original and all copies must be destroyed.

When the present Instruction handbook are handed over, corresponding sets of instruction handbooks of a previous version are automatically invalidated.

Please note that the specifications/data/information **are current values according to the printing date**. These statements are **not legally binding** with regard to measurements, computation or calculations.

Baumüller Nürnberg GmbH reserves the right, in developing its products further, to change the technical specifications and handling of its products concerned without prior notice.

No liability can be accepted concerning the correctness of these Instruction handbook unless otherwise specified in the General Conditions of Sale and Delivery.

© Baumüller Nürnberg GmbH

Ostendstr. 80 - 90
90482 Nuremberg
Germany

Tel. +49 9 11 54 32 - 0

Fax: +49 9 11 54 32 - 1 30

Email : mail@baumueller.com

Internet: www.baumueller.com



Table of Contents

1	General	9
1.1	Information on the instruction handbook	9
1.2	Key to symbols	10
1.3	Limitation of liability	11
1.4	Copyright protection	11
1.5	Other applicable documents	12
1.6	Spare parts	12
1.7	Disposal	12
1.8	Guarantee provisions	12
1.9	Customer service	13
1.10	Terms used	13
1.11	List of other applicable documents	13
2	Safety	15
2.1	Contents of the instruction handbook	15
2.2	Changes and modifications to the device	15
2.3	Usage for the intended purpose	16
2.4	Risk assessment according EU Directive	17
2.5	Responsibility of the operating company	19
2.6	Protective devices	20
2.7	Training of the personnel	21
2.8	Personal protective equipment	22
2.9	Special hazards	23
2.10	Fire fighting	24
2.11	Safety equipment	25
2.12	Conduct in case of danger or accidents	25
2.13	Signs and labels	26
3	Technical Data	33
3.1	Dimensions	33
3.1.1	Dimensions BM441X	34
3.1.2	Dimensions BM442X	35
3.1.3	Dimensions BM4X3X	37
3.1.4	Dimensions BM4X4X	39
3.1.5	Dimensions BM4X5X	41
3.1.6	Dimensions BM4X6X	46
3.1.7	Dimensions BM4X7X	50
3.2	Weight	52
3.3	Operating requirements	53
3.3.1	System types	53
3.3.2	Requirements to the energy supply / supply system	54
3.3.3	Motor requirements	56
3.3.4	Required environmental conditions	57
3.3.5	Correction factors if the operating conditions are changed	58
3.3.5.1	Installation altitude	58
3.3.5.2	Environmental temperature	59
3.3.5.3	Supply voltage	59
3.3.6	Coherence between rated current and peak current	61
3.3.7	Cooling	63



Table of Contents

3.4	Electrical data basic units	65
3.4.1	Electrical data of the universal units	65
3.4.1.1	Electrical data BM441X universal units	65
3.4.1.2	Electrical data BM442X universal units	68
3.4.1.3	Electrical data BM443X universal units	72
3.4.1.4	Electrical data BM444X universal units	75
3.4.1.5	Electrical data BM445X universal units	78
3.4.1.6	Electrical data BM446X universal units	81
3.4.1.7	Electrical data BM4X7X universal units	84
3.4.2	Electrical data BM46XX acceleration units	86
3.4.2.1	Electrical data BM4632 acceleration units	87
3.4.2.2	Electrical data BM464X acceleration units	89
3.4.2.3	Electrical data BM465X acceleration units	91
3.4.2.4	Electrical data BM466X acceleration units	93
3.4.3	Electrical data BM47XX continuous current units	95
3.5	Electrical data power modules	98
3.5.1	Electrical data BM442X power modules	98
3.5.2	Electrical data BM443X power modules	100
3.5.3	Electrical data BM444X power modules	102
3.5.4	Electrical data BM445X power modules	104
3.5.5	Electrical data BM446X power module	106
3.5.6	Electrical data BM447X power module	108
3.6	Additional data referring to water-cooled brake resistors	110
3.7	Output frequency dependent continuous current derating BM4XXX	116
3.8	Output frequency dependent maximum current derating BM46XX	117
3.9	Overload monitoring modes	118
4	Design and Operation	119
4.1	Functioning	120
4.2	Controller	121
4.2.1	Standard controller	122
4.2.2	ES controller	125
4.2.3	Encoder modules slot/position A and B	127
4.3	Interconnect devices	128
4.3.1	Mix mode BM443X generation 1 and 2	128
4.4	Type plate	129
4.5	Type code	130
4.5.1	Explanation type code	130
4.5.2	Explanation version code	134
4.6	UL notes	135
4.7	Display and operation elements	136
4.7.1	LEDs	136
4.7.2	7-segment display	139
4.7.3	Address switch S1 - S4 (only ES controller)	140
5	Transport and Packaging	145
5.1	Safety notes for transport	145
5.2	What to observe when transporting	145
5.3	Transport inspection	146
5.4	Unpacking	146
5.5	Disposal of the packaging	146



6	Mounting	147
6.1	Safety notes	147
6.2	Preparing for mounting	150
6.2.1	Drilling patterns	151
6.2.1.1	Drilling patterns BM441X	151
6.2.1.2	Drilling patterns BM442X	152
6.2.1.3	Drilling patterns BM4X3X	152
6.2.1.4	Drilling patterns BM4X4X	153
6.2.1.5	Drilling patterns BM4X5X	154
6.2.1.6	Drilling patterns BM4X6X	155
6.2.1.7	Drilling patterns BM4X7X	157
6.3	Mounting instructions	159
6.3.1	Requirements mounting plate for cold plate	166
6.3.2	Connecting the water cooler	166
7	Installation	167
7.1	Safety notes	167
7.2	Voltage test	169
7.3	Demands on the power supply	170
7.3.1	Connection instructions at special power supply systems	171
7.4	Requirements to the connecting cables	172
7.5	Protection of the device and the cable	172
7.6	PE connection and RCD compatibility	173
7.7	Installation requirements with regard to EMC	173
7.8	Avoid bearing currents	174
7.9	Requirements for the motor temperature sensors	177
7.10	Installation procedure	178
7.11	Wiring diagrams	180
7.11.1	Connection diagrams	180
7.11.1.1	BM44XX, BM46XX, BM47XX (basic units)	180
7.11.1.2	BM44XX, BM46XX, BM47XX power module	183
7.11.2	Terminal overviews	187
7.11.2.1	Terminals BM4412, BM4413	188
7.11.2.2	Terminals BM4414	189
7.11.2.3	Terminals BM442X	190
7.11.2.4	Terminals BM443X, BM463X	191
7.11.2.5	Terminals BM444X, BM464X	192
7.11.2.6	Terminals BM445X, BM446X, BM465X, BM466X	193
7.11.2.7	Terminals BM466X, BM476X	194
7.11.2.8	Terminals BM4755	195
7.11.2.9	Terminals BM447X, BM4773	196
7.11.3	Electrical connection power unit	198
7.11.4	Requirements for the screwing	201
7.12	Controller terminals	202
7.12.1	Encoder connection slot/position A and B	210
7.12.2	Analog input slot/position D and E	225
7.12.3	Digital inputs slot A to E/position D	227



Table of Contents

8	Operation	229
8.1	Safety notes	229
8.2	Operating concept	230
8.2.1	Enable signals	230
8.3	Power on switching frequency / DC link charging	231
8.3.1	Power supply switch-on frequency BM441X and BM442X	231
8.3.2	Power supply switch-on frequency BM443X (generation 1)	231
8.3.3	Power supply switch-on frequency BM443X generation 2, BM4X4X to BM4X7X	232
8.3.4	Calculation of the maximum permitted external capacity	233
8.3.5	Effects of the different charging circuits	234
8.3.6	Table of charging times	234
9	Troubleshooting and Fault Correction	235
9.1	Behavior in case of malfunctions	235
9.2	Monitoring functions	236
9.3	Fault detection	240
9.4	Error handling	244
9.4.1	Error reset	245
9.4.2	Error parameters, error messages, error reactions	246
9.4.2.1	Error messages (2nd level)	247
9.4.2.2	Sub-error messages (3rd level)	256
9.4.3	Warnings	264
10	Maintenance	267
10.1	Safety notes	267
10.2	Environmental condition	268
10.3	Inspection intervals - maintenance notes	268
10.3.1	Periodic maintenance	270
10.4	Repairs	272
11	Accessories and Spare Parts	273
11.1	Cabling	274
11.1.1	Cables power supply - device	274
11.1.2	Cables device - motor	276
11.1.3	Cable control voltage supply/signals	278
11.1.4	Interface cable RS232	278
11.2	Fuses	279
11.2.1	Fuses BM441X	281
11.2.2	Fuses BM442X	283
11.2.3	Fuses BM4X3X	286
11.2.4	Fuses BM4X4X	287
11.2.5	Fuses BM4X5X	290
11.2.6	Fuses BM4X6X	294
11.2.7	Fuses BM447X	298
11.2.8	UL fuse in the ballast circuit	299
11.2.9	24V extra-low voltage protection	299
11.3	Mains filters	300
11.3.1	Block diagram of filter for mains applications (simplified)	300
11.3.2	Baumüller mains filter type code	300
11.3.3	Required mains filter environmental conditions	300
11.3.4	Electrical data mains filter	301
11.3.5	Mains filter selection	304



11.4	Power chokes	306
11.5	Baumüller accessories	310
11.5.1	Shielding clamp	310
11.5.2	Cable RS232	310
11.5.3	Toroidal cores	311
11.5.4	Accessories Ethernet/EtherCAT®	312
11.5.5	Accessories - CANopen®	313
11.5.6	Encoder cables	314
11.5.7	Design cover and connectors	319
12	Shutdown, Storage	321
12.1	Safety instructions	321
12.2	Requirements to the executing personnel	322
12.3	Shutdown	322
12.4	Demounting	322
12.5	Storage conditions	323
12.6	Recommissioning	324
13	Disposal	325
13.1	Safety notes	325
13.2	Disposal facilities/authorities	327
Appendix A - Abbreviations		329
Appendix B - Information according EU Eco-Design Directive 2019/1781		331
Appendix C - Declaration of Conformity		347
Appendix D - Safe Stop		351
D.1	Methods to avoid an unexpected starting	351
D.2	Safe Torque Off (STO)	354
D.2.1	Safety classifications and safety notes	354
D.2.2	Function principle STO	357
D.2.2.1	Shutdown paths	358
D.2.2.2	Sequence diagram	359
D.2.2.3	Connection diagrams	362
D.3	Safe stop	364
D.3.1	Safety categories according to EN ISO 13849-1	364
D.3.2	The safety relay	365
D.3.3	Application example for machine of category 3	366
D.3.4	Application example for machine of category 4	368
D.3.5	Application expansions	370
D.4	Requirements on an OSSD test pulse	373
D.5	Technical data safety relay module	374
Table of Figures		377
Overview of Revisions		379



Table of Contents

1

GENERAL

1.1 Information on the instruction handbook

This instruction handbook provides important information on handling the device. A prerequisite for safe work is compliance with all specified safety notes and procedural instructions.

Additionally, the valid accident prevention regulations and general safety regulations applicable to the scope of application the device must be complied with.

Read the instruction handbook, particularly the safety notes chapter, completely before beginning any work on the device. The instruction handbook is part of the product and must be kept accessible to personnel at all times in the immediate vicinity of the device.

1.2 Key to symbols

Warning notes

Warning notes are identified by symbols in these instruction handbook. The notes are introduced by signal words that express the extent of the danger.

It is imperative that these notes be complied with and are conscientiously regarded in order to prevent accidents, personal injury and material damage.



DANGER!

...points out an immediately dangerous situation that will lead to severe injuries or death if not avoided.



WARNING!

...points out a potentially dangerous situation that could lead to severe injuries or death if not avoided.



CAUTION!

...points out a potentially dangerous situation that could lead to minor or slight injuries if not avoided.



NOTICE!

...points out a potentially dangerous situation that could lead to material damage if not avoided.

Recommendations



NOTE!

...highlights useful tips and recommendations, as well as information for efficient and problem-free use.

1.3 Limitation of liability

All specifications and notes in these instruction handbook were compiled taking into account the applicable standards and regulations, the state of the art and our knowledge and experience of many years.

The manufacturer assumes no liability for damages due to:

- noncompliance with the instruction handbook
- usage for other than the intended purpose
- usage by untrained personnel

The actual scope of delivery can vary in case of optional equipment, laying claim to additional order options, or on account of the latest technical changes to the explanations and representations described herein.

The user bears the responsibility for performing service and initial operation in accordance with the safety regulations of the applicable standards and all other relevant governmental or local regulations concerning the dimensioning and protection of conductors, grounding, disconnectors, overcurrent protection, etc.

The person who carried out the mounting or installation is liable for any damage incurred when assembling or connecting the device.

1.4 Copyright protection

The instruction handbook must be treated confidentially. It is to be used exclusively by personnel who work with the device. The consignment of the instruction handbook to third persons without the written permission of the manufacturer is prohibited.



NOTE!

The specific contents, text, drawings, images and other representations are copyrighted and subject to industrial property rights. Any prohibited usage is punishable by law.

EnDat®	is a registered trademark of Dr. Johannes Heidenhain GmbH, 83301 Traunreut, Germany
EtherCAT®	is a registered trademark of Beckhoff Automation GmbH, 33415 Verl, Germany
Hiperface®	is a registered trademark of SICK STEGMANN GmbH, 78166 Donaueschingen, Germany
SinCos®	is a registered trademark of SICK STEGMANN GmbH, 78166 Donaueschingen, Germany
b maXX®	is a registered trademark of Baumüller Nürnberg GmbH

1.5 Other applicable documents



NOTE!

Please note, that BAUMÜLLER is not responsible to examine whether any (industrial property) rights of third parties are infringed by the application-specific use of the BAUMÜLLER products/components or the execution.

1.5 Other applicable documents

Components of other manufacturers are integrated into the device. For these purchased parts, hazard assessments have been performed by the respective manufacturers. The compliance of the design construction with the applicable European and national regulations has been declared for the components by the respective manufacturers.

1.6 Spare parts



WARNING!

False or defective spare parts can lead to damage, malfunction or complete failure, thus endangering safety.

Therefore:

- Only use original spare parts of the manufacturer.

Procure spare parts through an authorized dealer or directly from the manufacturer.

Refer to [▶Accessories and Spare Parts◀](#) from page 273.

1.7 Disposal

Insofar as no take-back or disposal agreement has been made, please disassemble units correctly and properly recycle the constituent parts.

Refer to [▶Disposal◀](#) on page 325.

1.8 Guarantee provisions

The guarantee provisions are stated in a separate document of the sales documents.

The devices described herein may only be operated in accordance with the stipulated methods, procedures and conditions. Anything else not presented here, including the operation of devices in mounted positions, is not permitted and must be cleared with the plant on a case-by-case basis. If the devices are operated in any other manner than as described within these instruction handbook, then all guarantee and warranty rights are rendered null and void.

1.9 Customer service

Our customer service is available to provide you with technical information.

Info on the responsible contact persons is available at all times via telephone, fax, mail or the Internet.

1.10 Terms used

The term „device“ or the item designation BM4XXX are also used in this documentation for this Baumüller product „**b maXX 4000**“. A list of the abbreviations used can be found in [►Appendix A - Abbreviations◄](#) from page 329.

1.11 List of other applicable documents

Instruction handbook

	Doc No.	Part No. German	Part No. English
Instruction Handbook basic unit b maXX 4400, 4600, 4700 (ES)	5.12008	444495	444496

Parameter manual

	Doc No.	Part No. German	Part No. English
Parameter manual basic unit b maXX 4400, 4600, 4700 (ES)	5.03039	376339	377548

Instruction handbook function modules

	Doc No.	Part No. German	Part No. English
Analog I/O module BM4-F-AIO-XX or AIO-XX	5.01045	354844	372665
Digital I/O module BM4-F-DIO/FIO-XX or DIO/FIO-XX	5.01046	354843	372666
Encoder module BM4-F-ENC-XX or ENC-XX	5.01042	354842	372861
Incremental encoder emulation module BM4-F-IEE-XX or IEE-XX	5.02020	354858	376728
SSI encoder emulation module BM4-F-SIE-XX or SIE-XX	5.03056	377123	379049

Instruction handbook option modules

	Doc No.	Part No. German	Part No. English
DISC-NT slave BM4-O-DNT-XX	5.03007	367670	-
CANopen slave BM4-O-CAN-03	5.02014	368692	368693
CANopen slave programming handbook for controller	5.02065	368694	372860
CANopen over EtherCAT programming handbook	5.07017	413208	432414
CANopen slave for b maXX PLC application handbook	5.03057	376486	376487
b maXX drive PLC	5.01051	366197	354845
b maXX drive PLC application handbook	5.02004	366198	372017
BM4-O-ETH-01, BM4-O-ETH-02, BM4-O-CAN-04 for b maXX PLC	5.03001	366202	372042
BM4-O-ETH-01, BM4-O-ETH-02, BM4-O-CAN-04 CANopen master for b maXX PLC application handbook	5.03002	366203	372043
CANsync master for b maXX PLC	5.02056	366199	372025

1.11 List of other applicable documents

	Doc No.	Part No. German	Part No. English
CANsync slave for b maXX	5.02064	366201	372041
CANsync for b maXX PLC application handbook	5.02066	366200	372039
IEI for b maXX PLC	5.02013	366204	372044
PROFIBUS-DP slave for b maXX	5.03040	376488	376489
PROFIBUS-DP slave for b maXX PLC application handbook	5.03058	376490	376491
PROFIBUS-DP slave for b maXX controller programming handbook	5.03045	376757	377294
SERCOS slave module BM4-O-SER-01	5.04012	380910	381069
SERCOS slave module BM4-O-SER-01 parameter handbook	5.04013	381652	381653
EtherCAT slave module BM4-O-ECT-01/ECT-01	5.06003	394953	394954
Ethernet with EtherCAT master for b maXX drive PLC	5.07001	407996	407997
Ethernet with EtherCAT master for b maXX drive PLC application handbook	5.07002	407998	407999
Ethernet with EtherCAT for b maXX drive PLC	5.10018	433997	
POWERLINK Controlled Node BM4-O-PLK-01/PLK-01 ES	5.12072	444497	444498
POWERLINK Controlled Node BM4-O-PLK-01 ES application handbook	5.13013	445131	445132

2

SAFETY

This section provides an overview of all of the important safety aspects for optimum protection of personnel as well as for the safe and problem-free operation.

2.1 Contents of the instruction handbook

Each person who is tasked with performing work on or with the device must have read and understood the instruction handbook before working with the device. This also applies if the person who is involved with this kind of device or a similar one, or has been trained by the manufacturer.

2.2 Changes and modifications to the device

In order to prevent hazards and to ensure optimum performance, no changes, additions or modifications may be undertaken on the device that have not been explicitly approved by the manufacturer.

2.3 Usage for the intended purpose

The device is conceived and constructed exclusively for usage compliant with its intended purpose described in these instruction handbook.

The devices of the model series **BM4400**, **BM4600**, **BM4700** are either mains rectifier or active mains rectifier in combination with power modules with servo controller. Devices are also available in graduated design size and performance classes.

The devices **BM4400**, **BM4600**, **BM4700** are used exclusively as a converter for controlling a motor.

A device is considered as being used compliant with its intended purpose if all notes and information of these instruction handbook are adhered to.



WARNING!

Danger arising from usage for an unintended purpose!

Any usage that goes beyond the intended purpose and/or any non-compliant use of the device can lead to dangerous situations.

Therefore:

- Only use the device compliant with its intended purpose.
- Observe all specifications of these instruction handbook.
- Ensure that only qualified personnel work with/on this device.
- When configuring, ensure that the device is always operated within its specifications.
- Mount the device on a wall that can sufficiently bear the load.
- The device must always be operated within a control cabinet.
- Ensure that the power supply complies with the stipulated specifications.
- The device may only be operated in a technically flawless condition.
- Only operate the device in combination with components approved by Baumüller Nürnberg GmbH.
- The device has been developed in such a manner that it fulfills the requirements of the category C3 according to IEC 61800-3:2012.
- The device is not intended to be connected to the public power supply system. To operate the device in primary surroundings of the category C2/C1 (residential, business and commercial areas, directly on a public low-voltage power supply without an intermediate transformer), special measures to reduce the transient emissions (line-internal and radiated) must be provided for and certifiable by the system builder. Otherwise, EMC interference could occur without such additional measures.

2.4 Risk assessment according EU Directive

Earth current	<p>Check the quality of the earth connection:</p> <ul style="list-style-type: none">- before connecting the device to the power supply for the first time and- within the recommended service intervals <p>Requirements:</p> <ul style="list-style-type: none">• Cross section of the grounding cable according EN 61800-5-1• Note the required torque of connection!• Grounded mounting plate made of metal• Mains filter, device and shielding of the motor cable are on the same HF potential
Stored electric charge	<p>Do not touch electrically live parts before the discharge time of 15 min runs up, check zero-potential before touching.</p>
Electromagnetic fields	<p>The device causes electromagnetic fields when operating.</p> <p>Any person with individual device for cardiac assistance (pacemaker, defibrillator) must stay in sufficient distance to the operating device.</p>
Burn injuries	<p>Please note that the surface of the device can heat up considerably.</p> <ul style="list-style-type: none">• Wear safety gloves!
Radiated emission	<p>The high-frequency electromagnetic fields within the operation environment must not exceed the field strength of the second environment according EN 61800-3.</p>
Internal or external ignition source	<p>Internal or external ignition sources are not allowed within the environment of the devices!</p> <ul style="list-style-type: none">• Use ABC powder for extinguishing a fire!
Gas	<p>Toxic fumes can be released in case of failure.</p> <p>No flammable fume or dust and no flammable/explosive gases are permitted within the environment of the devices!</p> <p>In order to avoid damage to persons because of explosions:</p> <ul style="list-style-type: none">• ventilate the area and• immediate evacuation.
Transportation and mounting	<p>Falling down of the device can cause damage to persons.</p> <p>Note the weight of the device when selecting the mounting screws!</p> <p>Select the fastening torques of the mounting screws according the specification of the screw manufacturer!</p> <ul style="list-style-type: none">• Wear safety helmets/shoes!

2.4 Risk assessment according EU Directive

Mounting

Unprotected hands can be injured at the sharp edges of the device.

- Wear safety gloves!

Unprotected eyes can be injured by thrown up metal particles caused by drilling or making cut-outs.

- Wear safety glasses!

Short-circuit in power cables

In case of a short-circuit high current flows. This current induces a magnetic field in cable loops. The magnetic field can cause failures of the device.

To avoid additional damage in case of a short-circuit in power cables,

- The connection between power supply and device or between device and motor must be laid without loop.

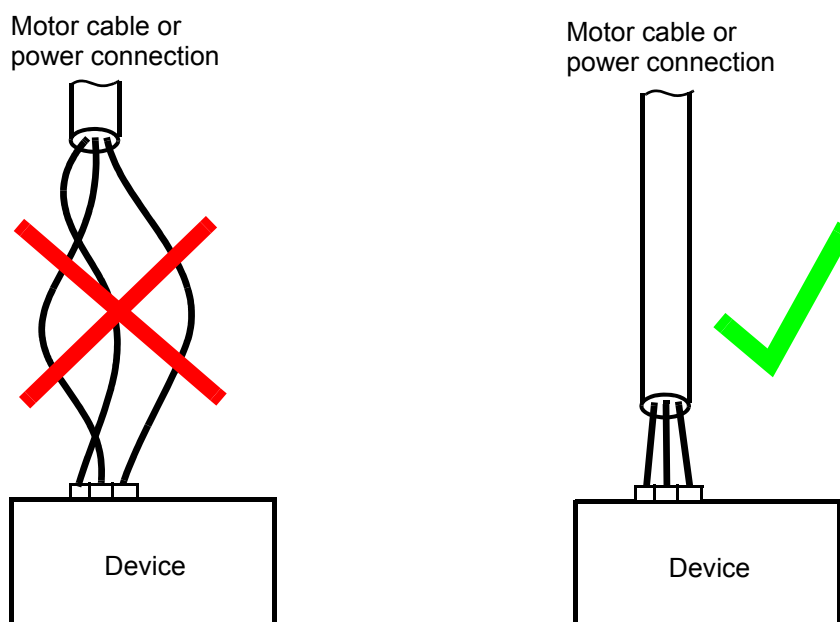

Figure 1: Wiring of the power cables

Installation

If a shielded cable is connected unshielded and this causes failure of the device/danger to persons, the system manufacturer is responsible for.

Brake resistor connection

The dissipation of the heat loss of the external brake resistor must be ensured.

Communication errors

Ensure that a failure of the device will cause no danger to persons.

The safety notes of all further chapters of this documentation need to be carefully observed!

2.5 Responsibility of the operating company

The device will be used in commercial areas. Thus, the proprietor of the device is subject to the legal work safety regulations.

Along with the notes on work safety in these instruction handbook, the safety, accident prevention and environmental protection regulations valid for the area of application of this device must be complied with. Whereby:

- The operating company must inform himself about the applicable work health and safety regulations and ascertain, in a hazard assessment, any additional hazards that could arise from the special working conditions in the use area of the device. These must then be implemented in the form of instruction handbook for operation of the device.
- These instruction handbook must be kept accessible to personnel working with the device at all times in the immediate vicinity of the device.
- The specifications of the instruction handbook must be adhered to completely and without exception.
- The device may only be operated in a technically faultless and operationally safe condition.

2.6 Protective devices

Protection class	
BM441X, BM442X	IP 20
BM443X, BM444X BM463X, BM464X	IP 20, with a contact-isolated connection in accordance with IP 20, otherwise IP 10.
BM445X, BM446X, BM447X BM465X, BM466X BM475X, BM476X, BM477X	IP 00

All devices **BM4400**, **BM4600**, **BM4700** must be installed in an appropriate control cabinet to meet the protection classification required in EN 61800-5-1, chapter 4.2.3.3 (IP 30: only upper horizontal surfaces; IP 20: all other surfaces).



DANGER!

Risk of fatal injury from electrical current!

There is an immediate risk of fatal injury if live electrical parts are contacted.

Therefore:

- The device must be in operated inside of a control cabinet that provides protection against direct contact of the devices and at least meets the requirements of EN 61800-5-1, Chapter 4.2.3.3.
- Fault protection according EN 60204-1:2018, section 6.3 is fulfilled by measures of preventing touch voltages.

2.7 Training of the personnel

**WARNING!****Risk of injury due to insufficient qualifications!**

Improper handling can lead to significant personal injury and material damage.

Therefore:

- Certain activities can only be performed by the persons stated in the respective chapters of these instruction handbook.

In these instruction handbook, the following qualifications are stipulated for various areas of activity:

- **Operating personnel**

- The drive system may only be operated by persons who have been specially trained, familiarized and authorized.
- Troubleshooting, maintenance, cleaning, maintenance and replacement may only be performed by trained or familiarized personnel. These persons must be familiar with the instruction handbook and act accordingly.
- Initial operation and familiarization may only be performed by qualified personnel.

- **Qualified personnel**

- Electrical engineers authorized by Baumüller Nürnberg GmbH, and qualified electricians of the customer or a third party who have learned to install and maintain Baumüller drive systems and are authorized to ground and identify electrical power circuits and devices in accordance with the safety engineering standards of the company.
- Qualified personnel have had occupational training or instruction in accordance with the respective locally applicable safety engineering standards for the upkeep and use of appropriate safety equipment.

2.8 Personal protective equipment

The wearing of personal protective equipment is required when working in order to minimize health and safety risks.

- The protective equipment necessary for each respective type of work shall always be worn during work.
- The personal safety signs present in each working area must be observed.



Protective work clothing

should be snug-fitting work clothes, with low tearing resistance, narrow sleeves and with no extending parts. It serves to primarily protect against...

No rings or chains should be worn.



Hard hat

to protect against falling down and flying around objects.



Safety shoes

to protect against heavy objects falling down.



Protective gloves

to protect hands against friction, abrasion, puncturing or more severe injuries, as well as contact with hot objects.

Wear for special work.



Protective eye wear

to protect the eyes against flying around objects and sprayed liquids.

2.9 Special hazards

In the following section, the remaining marginal risks will be stated that have been identified as a result of the hazard analysis.

Observe the safety notes listed here and the warning notes in the further chapters of this Instruction handbook to reduce health risks and dangerous situations.

Electrical current



DANGER!

Risk of fatal injury from electrical current!

There is an immediate risk of fatal injury if live electrical parts are contacted. Damage to the insulation or individual components can be life-threatening.

Therefore:

- Switch off the electrical power immediately in case of damage to the power supply insulation.
- Only allow work on the electrical system to be performed by qualified personnel.
- Switch off the current when any kind of work is being performed on the electrical system and ensure safety before switching on again.

Danger from residual energy



DANGER!

Risk of fatal injury from electrical current!

Stored electric charge.

Discharge time of the rack system = discharge time of the device with the longest DC link discharge time in the rack system.

Refer to [▶Electrical data basic units◀](#) from page 65.

Therefore:

- Do not touch electrically live parts before taking into account the discharge time of the capacitors.
- Pay attention to the corresponding notes on the device.
- If additional capacitors are connected to the DC link, the DC link discharge can take a much longer time. In this case, the necessary waiting period must itself be determined or a measurement made as to whether the equipment is de-energized. This discharge time must be posted, together with an IEC 60417-5036 (2002-10) warning symbol, on a clearly visible location of the control cabinet.

2.10 Fire fighting

Moving components



WARNING!

Risk of injury from moving components!

Rotating components and/or components moving linearly can result in severe injury.

Therefore:

- Do not touch moving components during operation.
- Do not open any covering during operation.
- The amount of residual mechanical energy depends on the application. Powered components still turn/move for a certain length of time even after the power supply has been switched off. Ensure that adequate safety measures are taken.

2.10 Fire fighting



DANGER!

Risk of fatal injury from electrical current!

There is a risk of electric shock if an electrically-conductive, fire-extinguishing agent is used.

Therefore:

- Use the following fire-extinguishing agent:



ABC powder / CO₂

2.11 Safety equipment

**WARNING!****Risk of fatal injury due to non-functional safety equipment!**

Safety equipment provides for the highest level of safety in a facility. Even if safety equipment makes work processes more awkward, under no circumstances may they be circumvented. Safety can only be ensured by intact safety equipment.

Therefore:

- Before starting to work, check whether the safety equipment is in good working order and properly installed.

2.12 Conduct in case of danger or accidents

Preventive measures

- Always be prepared for accidents or fire!
- Keep first-aid equipment (e.g. first-aid kits, blankets, etc.) and fire extinguishers readily accessible.
- Familiarize personnel with accident alarm, first aid and rescue equipment.

And if something does happen: respond properly.

- Stop operation of the device immediately with an EMERGENCY Stop.
- Initiate first aid measures.
- Evacuate persons from the danger zone.
- Notify the responsible persons at the scene of operations.
- Alarm medical personnel and/or the fire department.
- Keep access routes clear for rescue vehicles.

2.13 Signs and labels

The following symbols and information signs are located in the working area. They refer to the immediate vicinity in which they are affixed.



WARNING!

Risk of injury due to unreadable symbols!

Over the course of time, stickers and symbols on the device can become dirty or otherwise unrecognizable.

Therefore:

- Maintain all safety, warning and operating labels on the device in easily readable condition.



Electrical voltage

Only qualified personnel may work in work areas that identified with this.

Unauthorized persons may not touch working materials marked correspondingly.



DANGER!

Risk of fatal injury from electrical current!

Stored electric charge.

Discharge time of the rack system = discharge time of the device with the longest DC link discharge time in the rack system.

Refer to [▶Electrical data basic units◀](#) from page 65.

Therefore:

- Do not touch before taking into account the discharge time of the capacitors and electrically live parts.
- Heed corresponding notes on the equipment.
- If additional capacitors are connected to the DC link, the DC link discharge can take a much longer time. In this case, the necessary waiting period must itself be determined or a measurement made as to whether the equipment is de-energized. This discharge time must be posted, together with an IEC 60417-5036 (2002-10) warning symbol, on a clearly visible location of the control cabinet.



CAUTION!

Risk of injury due to hot surface!

Therefore:

- Wear protective gloves



NOTE!

When in operation, the top of the device can heat up to temperatures > 70 °C!

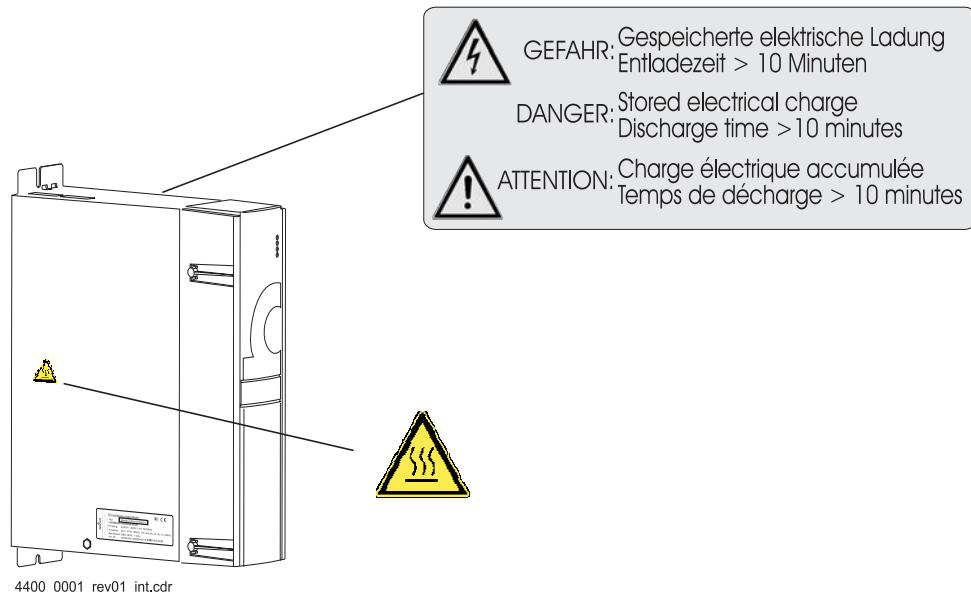

Figure 2: Signs and labels BM4X1X

2.13 Signs and labels

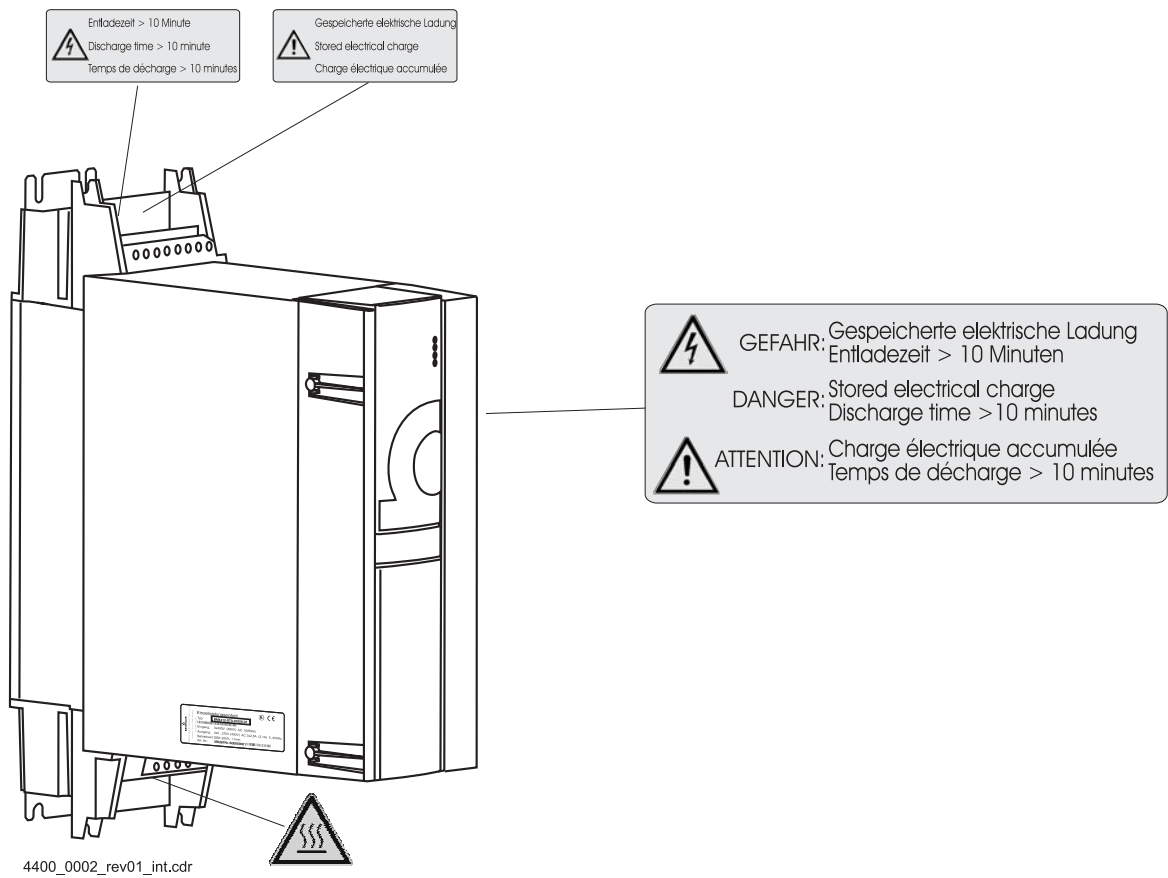

Figure 3: Signs and labels BM4X3X/BM4X4X

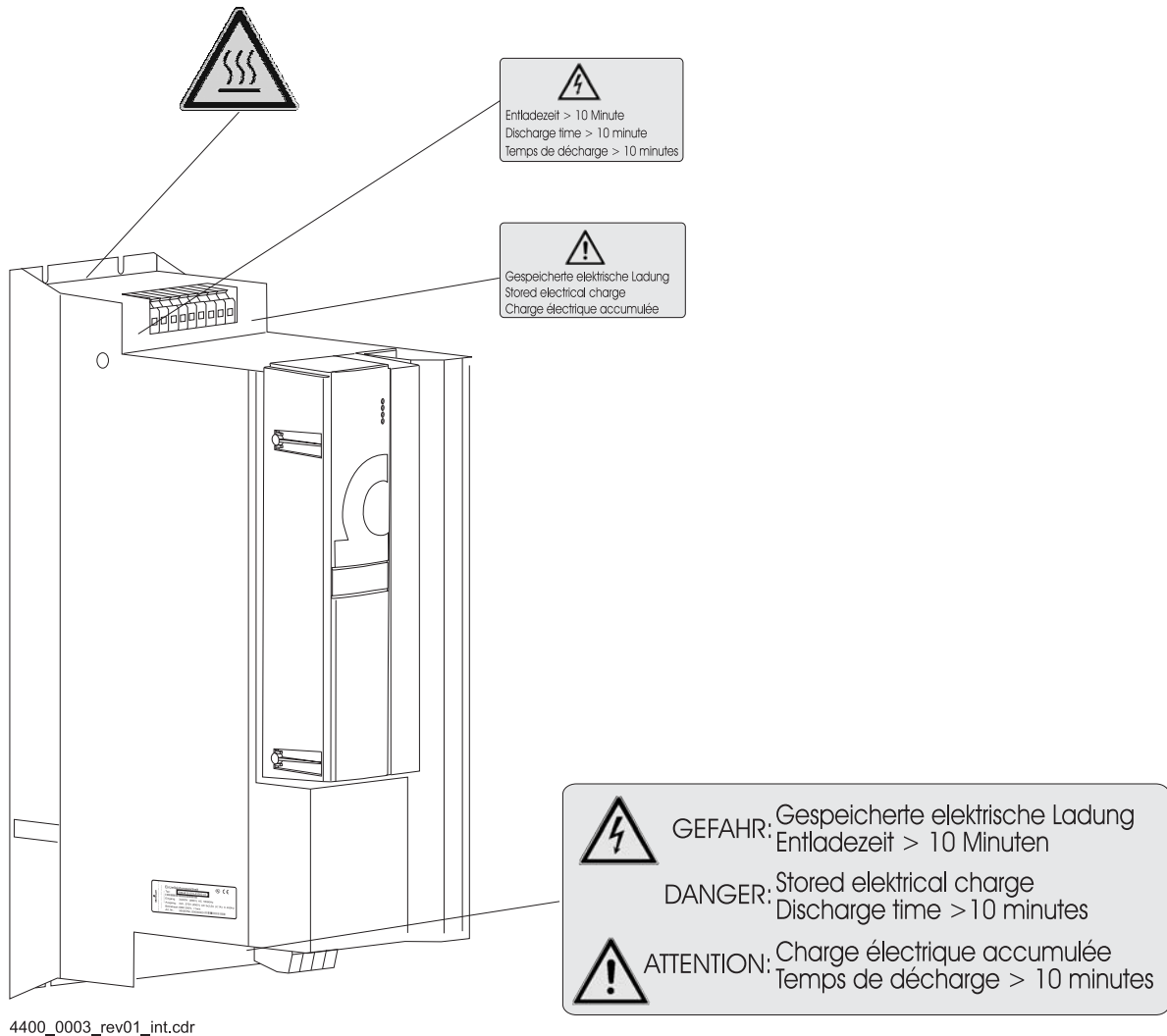

Figure 4: Signs and labels BM4X5X

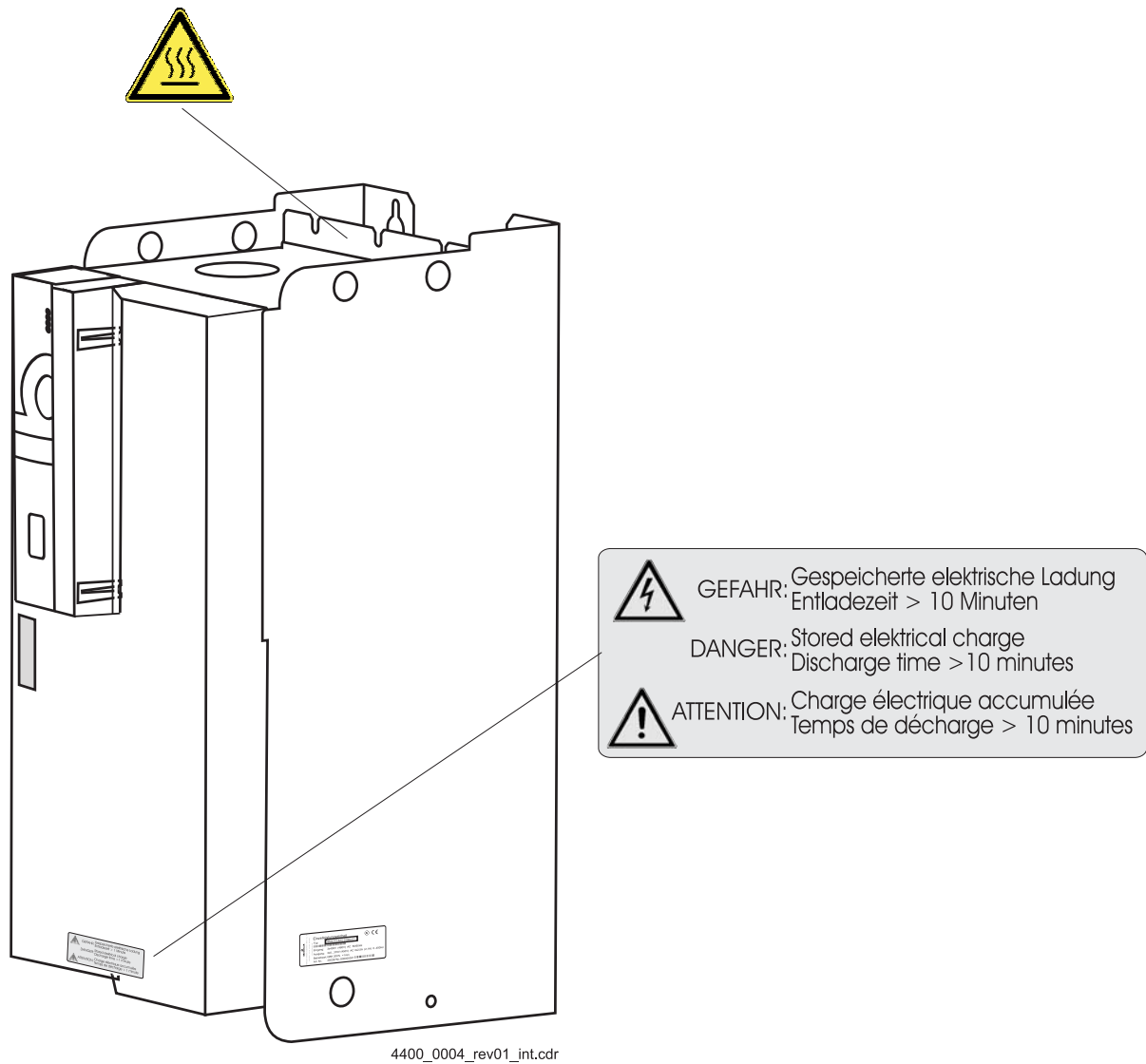

Figure 5: Signs and labels BM4X6X, BM4X7X

Signs and labels
devices with
safety level



NOTE!

Only a device marked with the TÜV Rheinland certification label and the safety label fulfills a certified safety function within the meaning of PL classification according ISO 13849 or SIL according EN 61800.



new logo



former logo

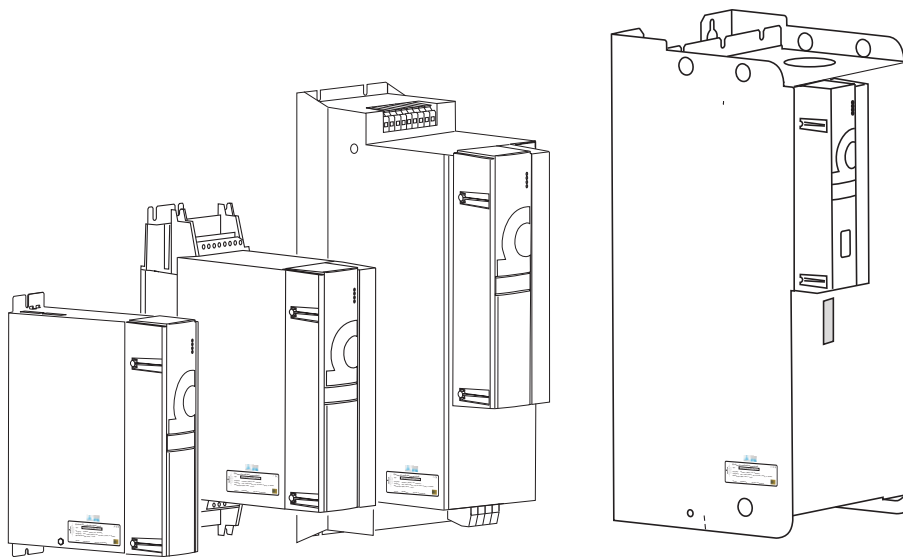

4400_0012_rev01_int.cdr



 <small>BAUMÜLLER Maschinenbau GmbH 42699 Solingen Postfach 10 15 50 0420 3000-0 www.baumuller.de</small>	Einbau-Einzelleistungseinheit		UL CE
	Typ: BM4453-FI-01244- S01-03		
	Eingang: 3x400V (480V) AC 50/60Hz		
	Ausgang: 3x0...400V (460V) AC 3x150A (125A) 0..450Hz		
	Betriebsart: GBK 130% <1min		
Art.Nr.: 06500275	Ser.Nr.: 311035532		

Figure 6: Type code labeling

TECHNICAL DATA

3.1 Dimensions

The following dimension drawings show the main dimensions of the devices. By means of the dimension drawings the space requirements within the control cabinet are determined. The dimension drawings in [▶Drilling patterns◀](#) from page 151 must be used in order to do the required drilling / segments.

**NOTE!**

All dimensions in mm.

**NOTE!**

Only the basic controller has a design cover.

**NOTE!**

The following devices are shown with design cover. The ES controller is designed without a design cover. The depth of the device was reduced by 66.5 mm due to this. It must be considered that the connectors and cables require additional space.

3.1 Dimensions

3.1.1 Dimensions BM441X

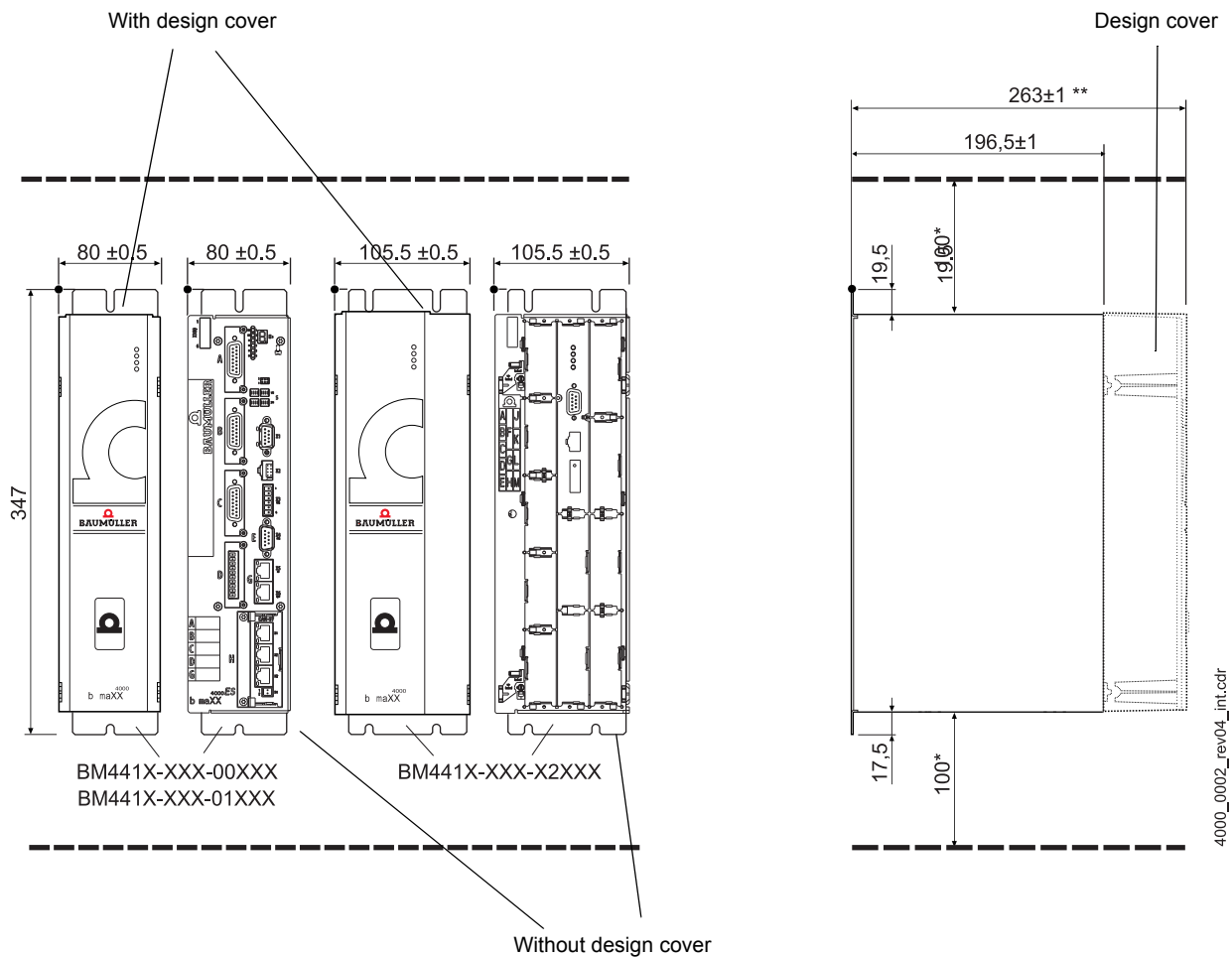
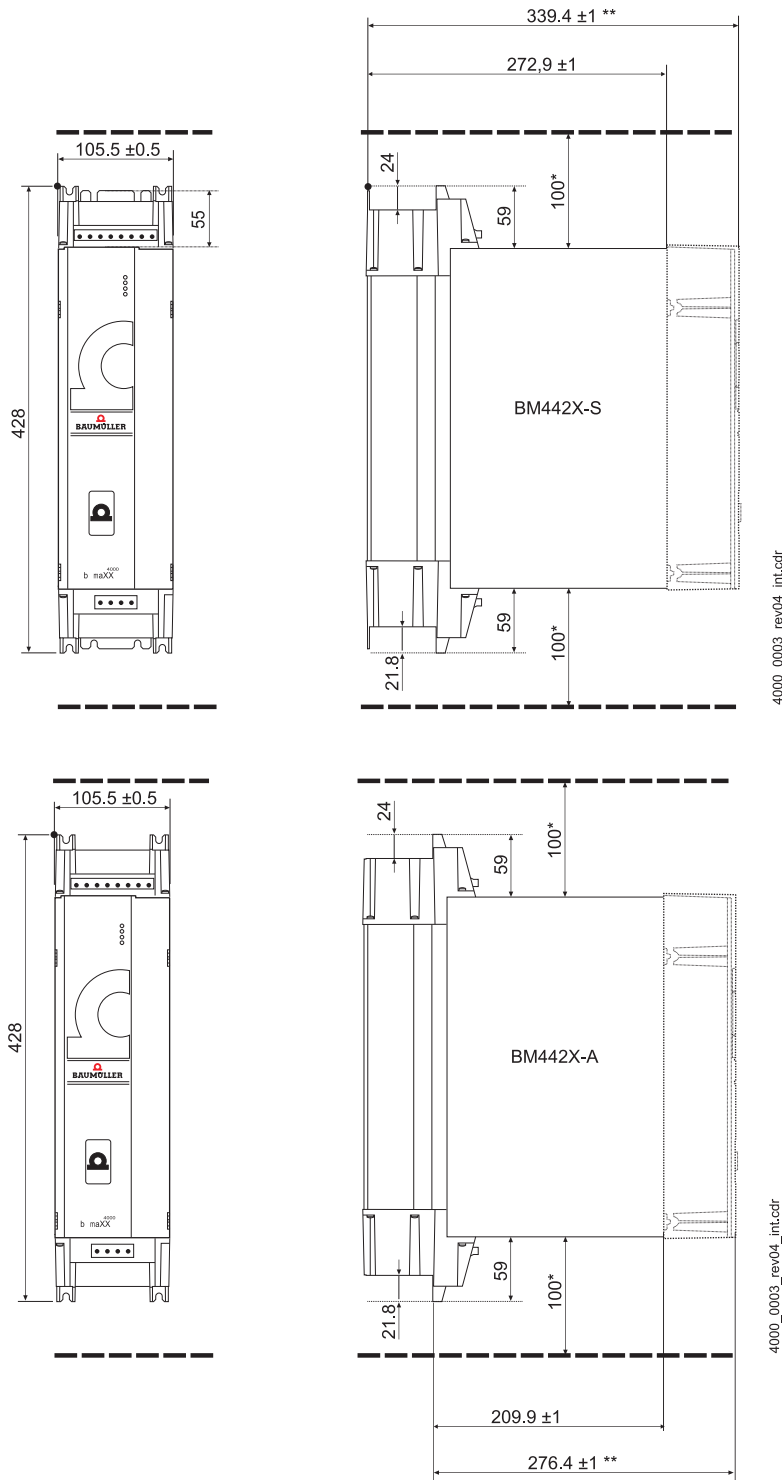

Figure 7: Dimensions BM441X * : Observe minimum clearance, Observe [►Cooling◀](#) from page 63

** : Dimensions specified with design cover. The ES controller is not equipped with a design cover.

3.1.2 Dimensions BM442X



4000_0003_rev04_int.cdr

4000_0003_rev04_int.cdr

Figure 8: Dimensions BM442X-S/A

*: Observe minimum clearance, Observe [▶Cooling◀](#) from page 63.

** : Dimensions specified with design cover. The ES controller is not equipped with a design cover.

3.1 Dimensions

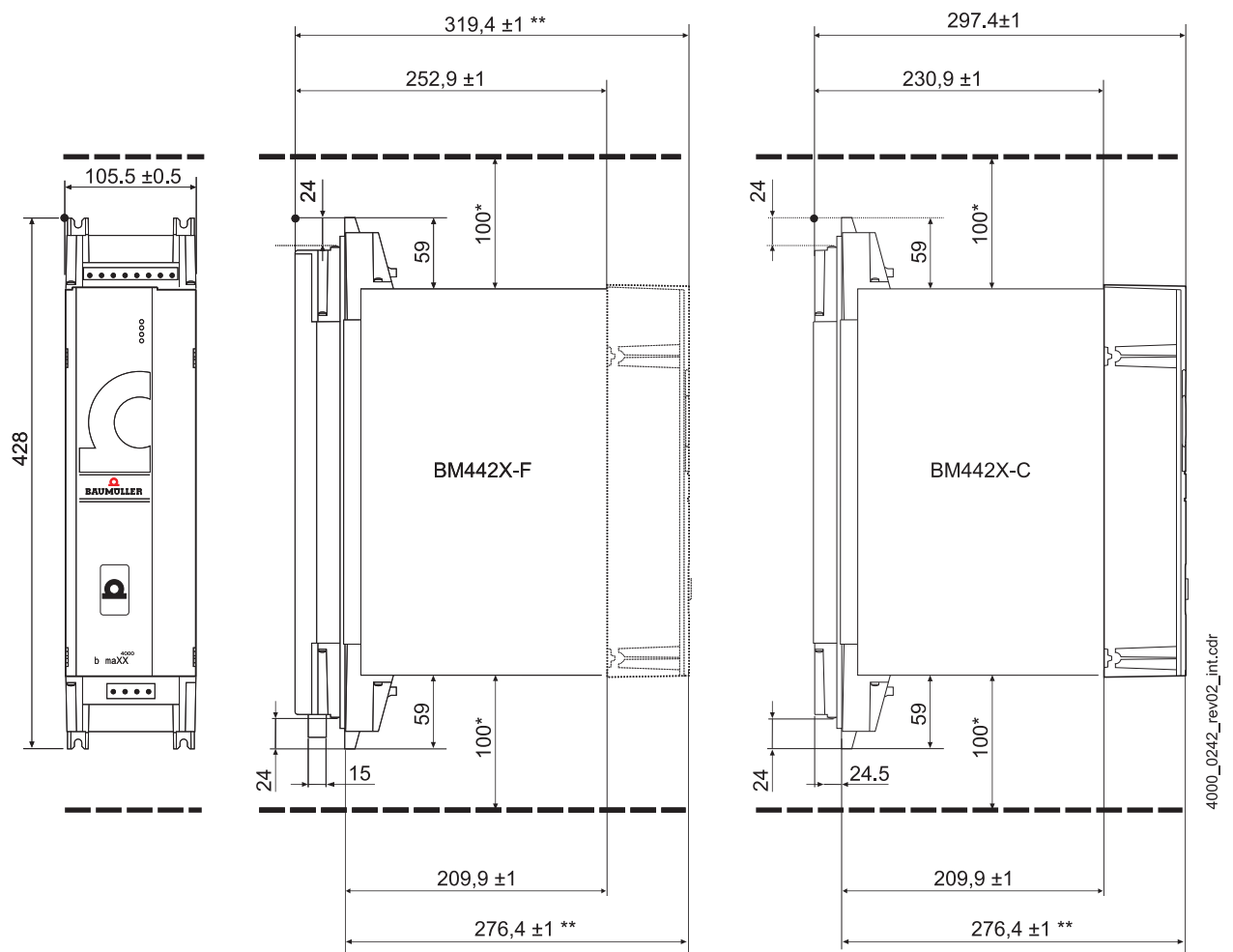

Figure 9: Dimensions BM442X-F/C

*: Observe minimum clearance, Observe [▶Cooling◀](#) from page 63.

** : Dimensions specified with design cover. The ES controller is not equipped with a design cover.

3.1.3 Dimensions BM4X3X

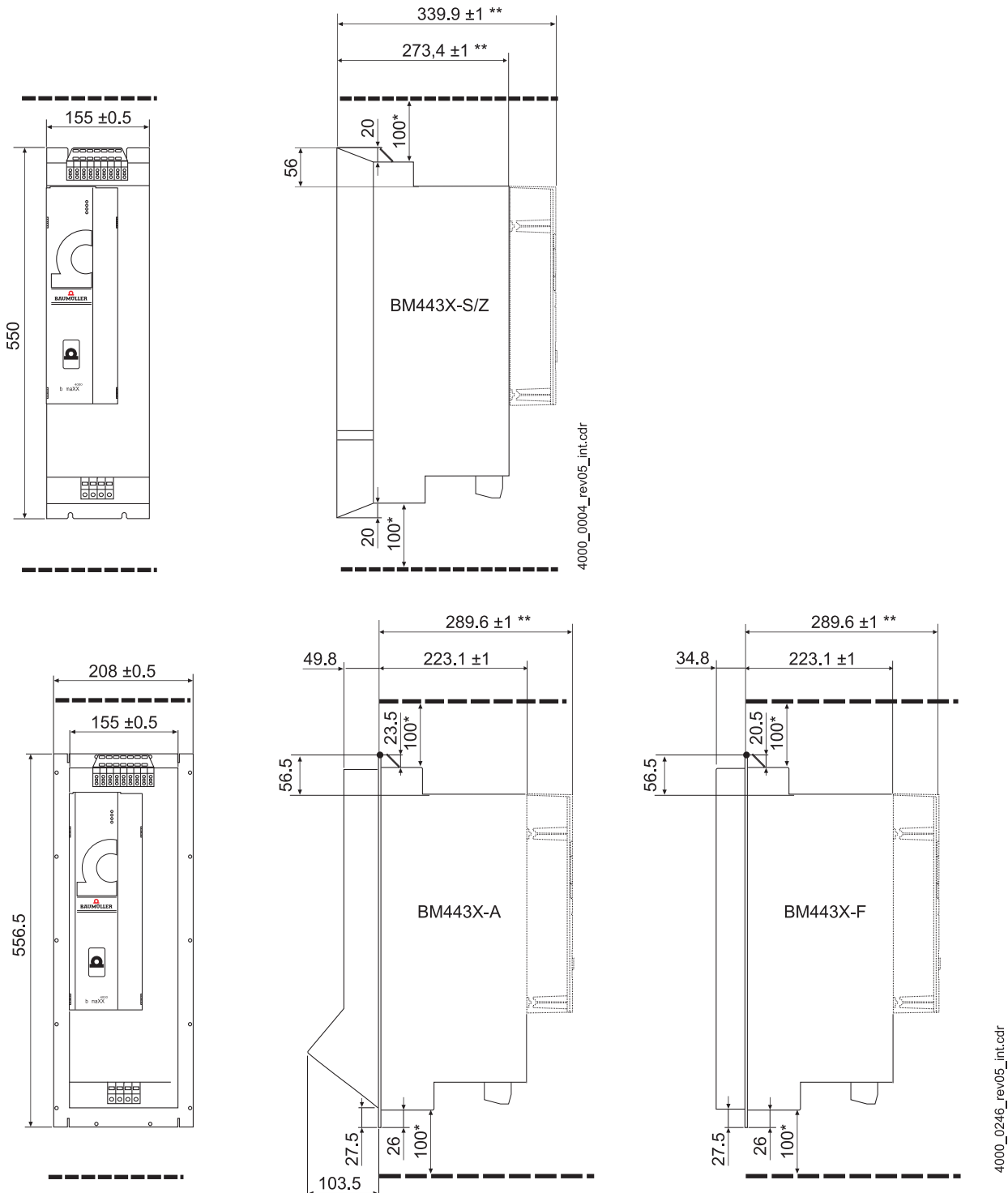

Figure 10: Dimensions BM443X-S/Z, BM443X-A/F * : Observe minimum clearance, Observe >Cooling< from page 63.
 **: Dimensions specified with design cover. The ES controller is not equipped with a design cover.

Devices BM4XXX-F... with option brake resistor Ryy: The depth of the cooling part outside the switching cabinet increases by 25 mm.

3.1 Dimensions

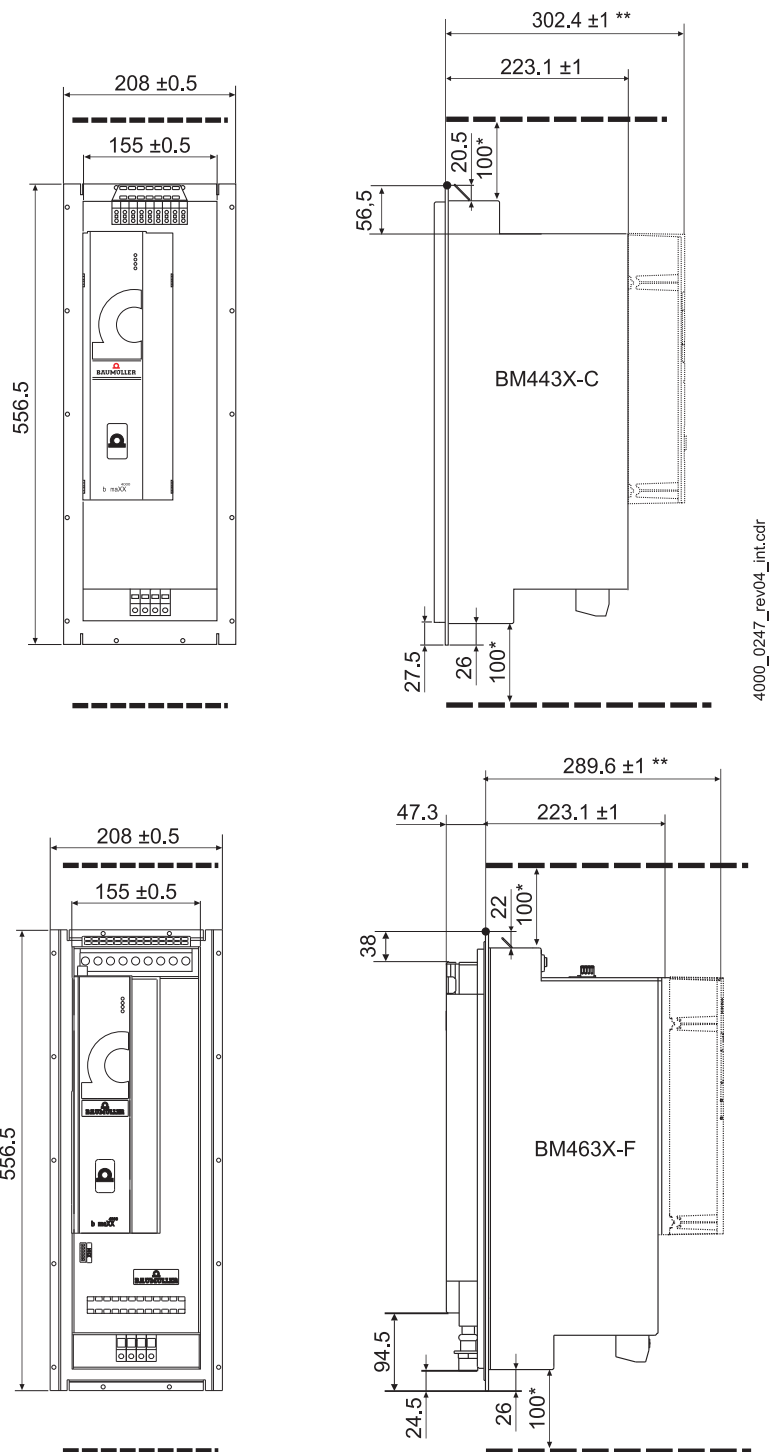

Figure 11: Dimensions BM443X-C, BM463X-F

*: Observe minimum clearance, Observe **>Cooling<** from page 63.

** : Dimensions specified with design cover. The ES controller is not equipped with a design cover.

Devices BM4XXX-F... with option brake resistor Ryy: The depth of the cooling part outside the switching cabinet increases by 25 mm.

3.1.4 Dimensions BM4X4X

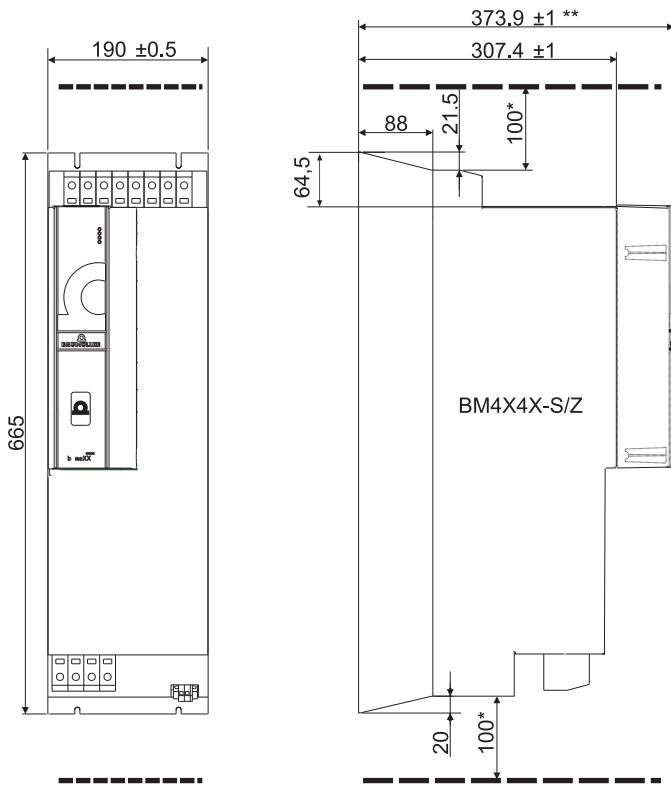

4000_0337_rev03_int.cdr

Figure 12: Dimensions BM444X-S/Z, BM464X-S/Z *: Observe minimum clearance, Observe [▶Cooling◀](#) from page 63.
 **: Dimensions specified with design cover. The ES controller is not equipped with a design cover.

3.1 Dimensions

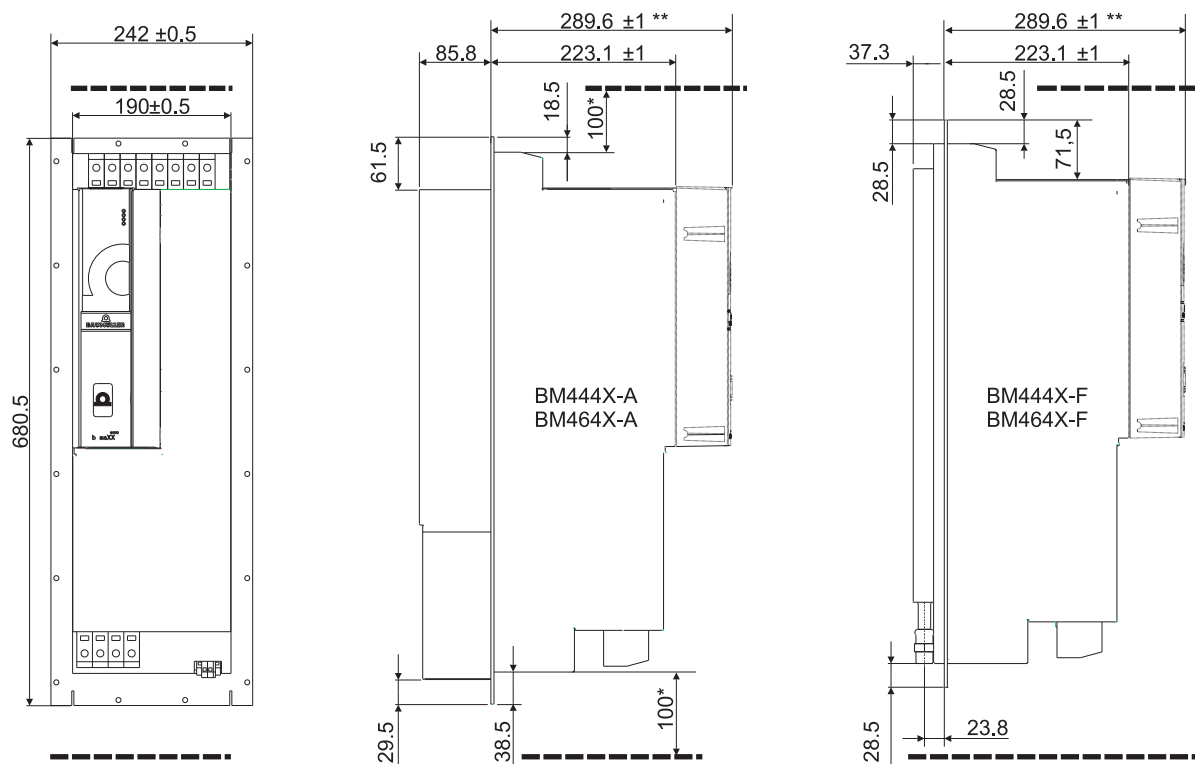

Figure 13: Dimensions BM444X-A/F, BM464X-A/F * : Observe minimum clearance, Observe [▶Cooling◀](#) from page 63.
 **: Dimensions specified with design cover. The ES controller is not equipped with a design cover.

Devices BM4XXX-F... with option brake resistor Ryy: The depth of the cooling part outside the switching cabinet increases by 25 mm.

4000_0336_rev04_int.cdr

3.1.5 Dimensions BM4X5X

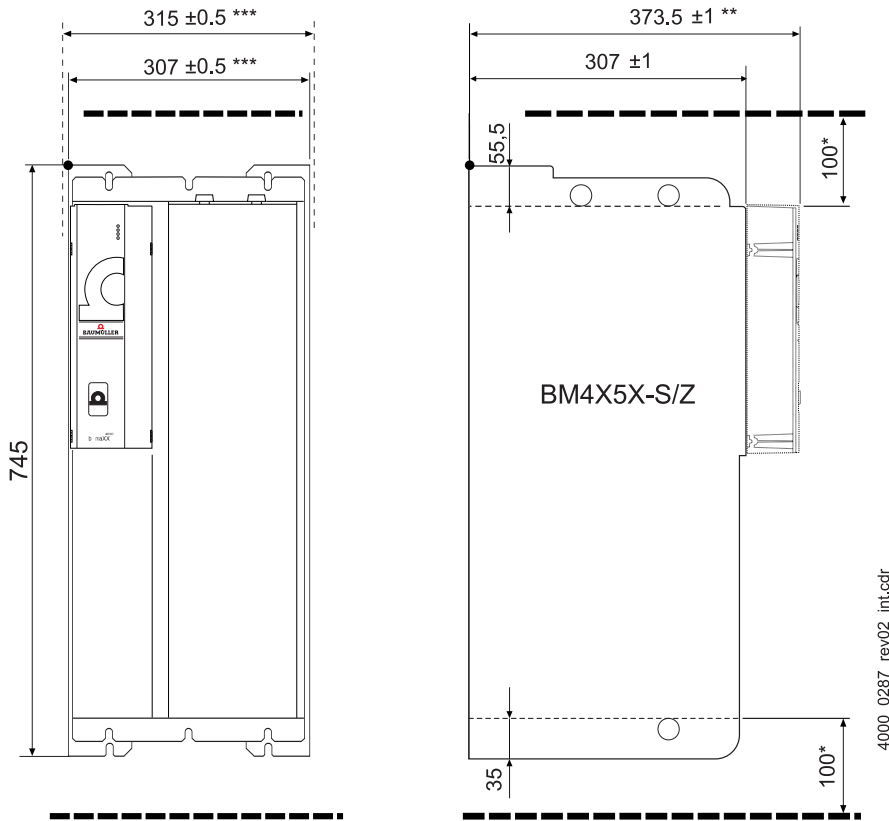

Figure 14: Dimensions BM445X-S/Z, BM465X-S/Z

- *: Observe minimum clearance, Observe [▶Cooling◀](#) from page 63.
- ** : Dimensions specified with design cover. The ES controller is not equipped with a design cover.
- ***: Width including screw heads.

3.1 Dimensions

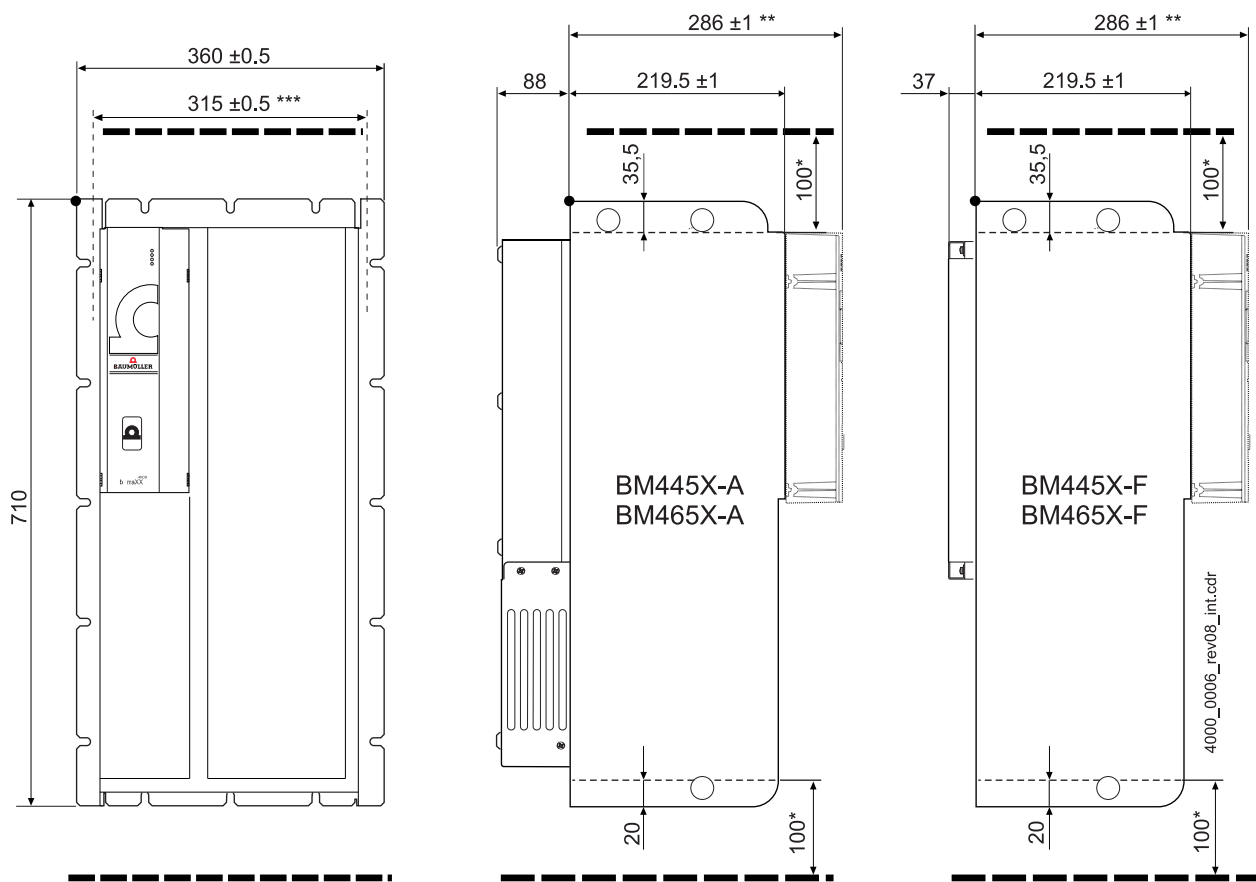

Figure 15: Dimensions BM445X-A/F, BM465X-A/F

*: Observe minimum clearance, Observe [▶Cooling◀](#) from page 63.

** : Dimensions specified with design cover. The ES controller is not equipped with a design cover.

***: Width including screw heads.

Devices BM4XXX-F... with option brake resistor Ryy: The depth of the cooling part outside the switching cabinet increases by 25 mm.



NOTE!

The device BM4X5X-AX-0XXX was extended by about 70 mm downwards with an additional protective plate against contact.

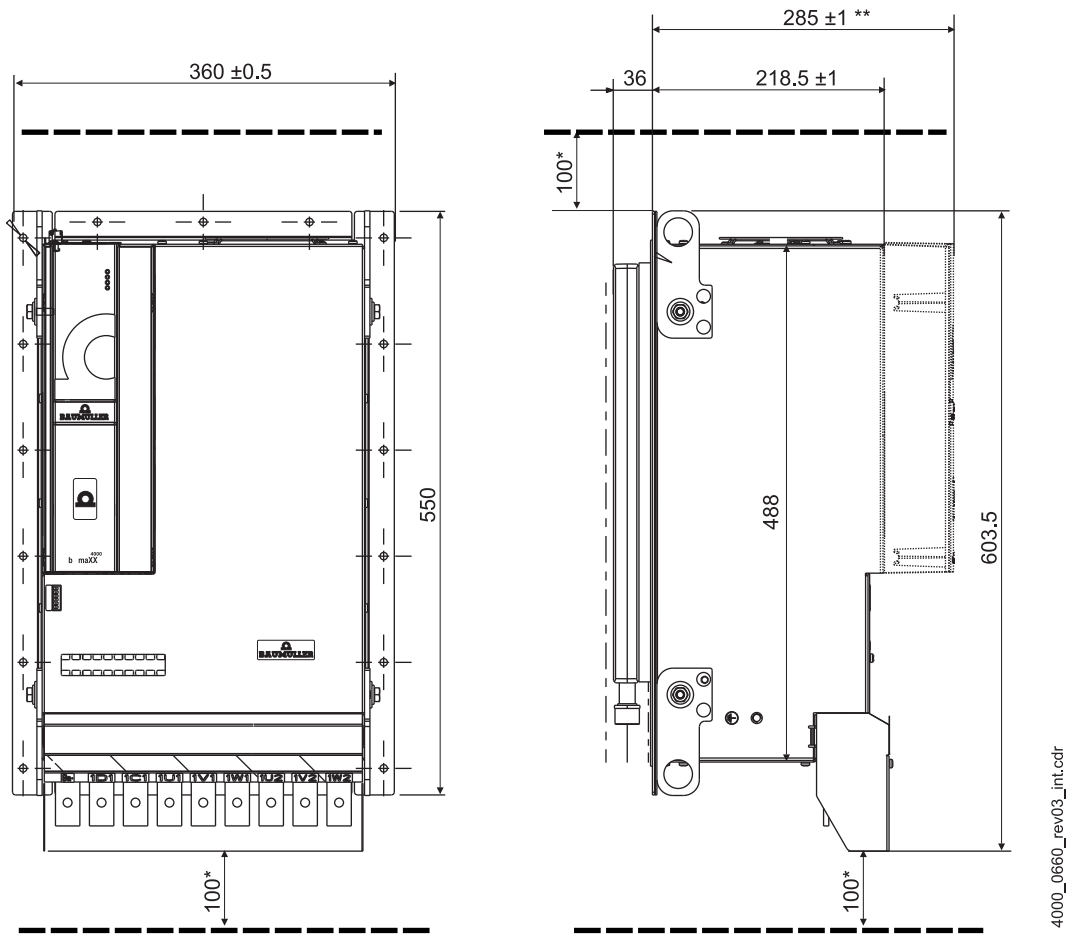

*: Observe minimum clearance, Observe [Cooling](#) from page 63.

** : Dimensions specified with design cover. The ES controller is not equipped with a design cover.

Devices BM4XXX-F... with option brake resistor Ryy: The depth of the cooling part outside the switching cabinet increases by 25 mm.

Figure 16: Dimensions BM465X-FXX-3XXXX and BM475X-FXX-3XXXX

3.1 Dimensions

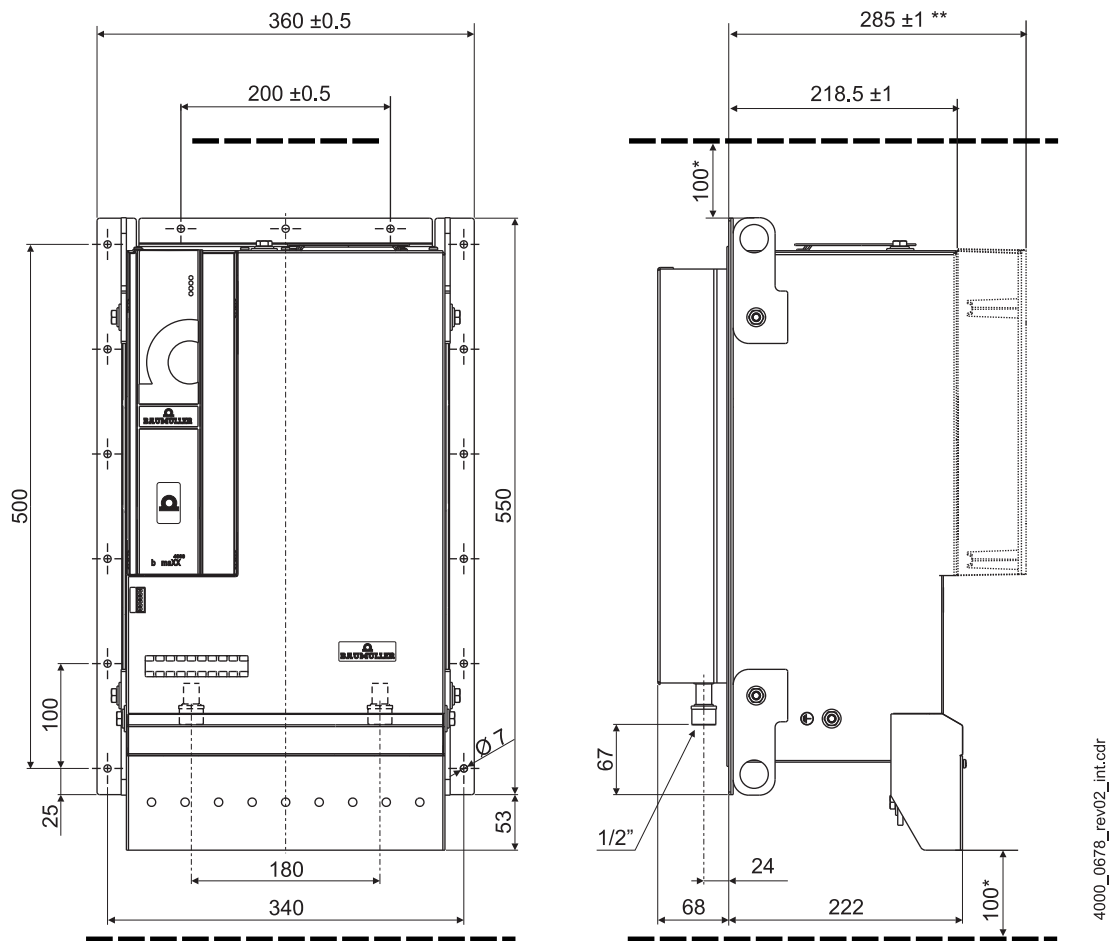

4000_0678_rev02_int.cdr

*: Observe minimum clearance, Observe [►Cooling◄](#) from page 63.

** : Dimensions specified with design cover. The ES controller is not equipped with a design cover.

Figure 17: Dimensions BM465X-FXX-3XXXX-RYY, BM475X-FXX-3XXXX-RYY

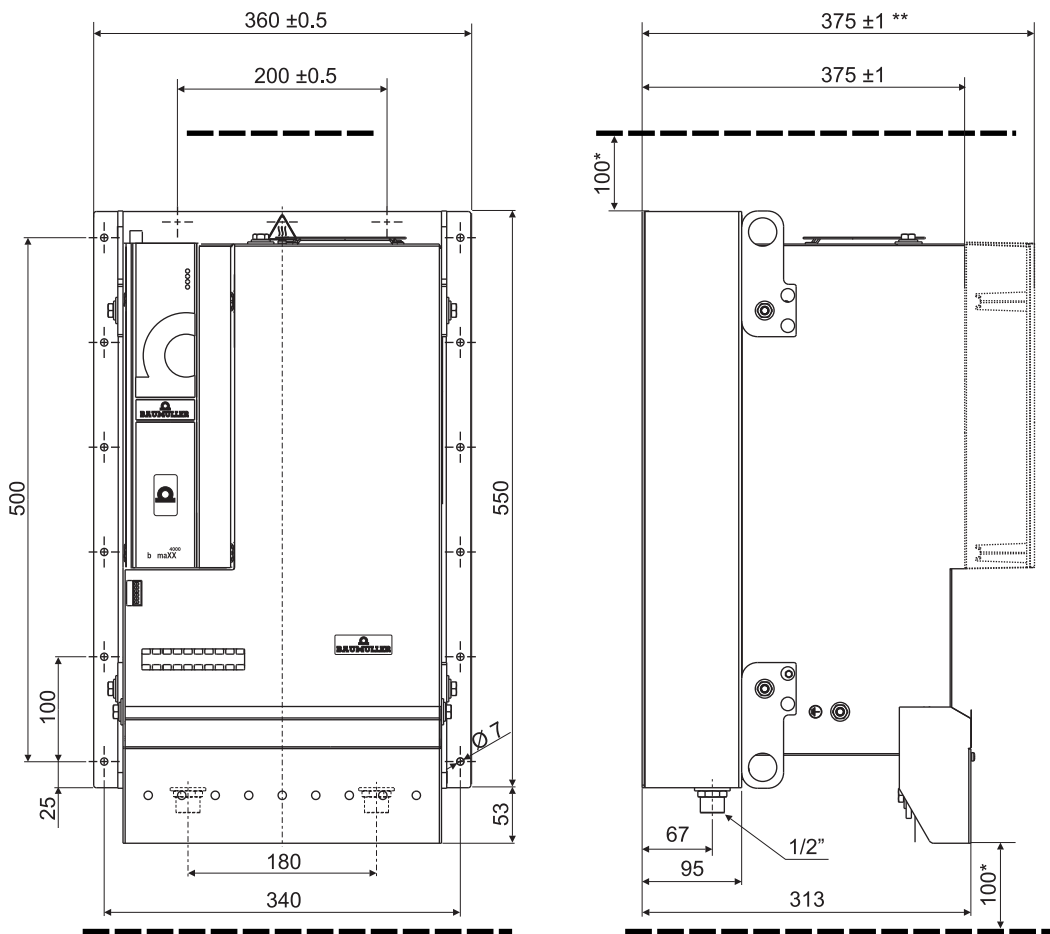

4000_0680_rev02_int.cdr

- *: Observe minimum clearance, Observe [Cooling](#) from page 63.
- ** : Dimensions specified with design cover. The ES controller is not equipped with a design cover.

Figure 18: Dimensions BM465X-ZXX-3XXXX-[RYY], BM475X-ZXX-3XXXX-[RYY]

3.1 Dimensions

3.1.6 Dimensions BM4X6X

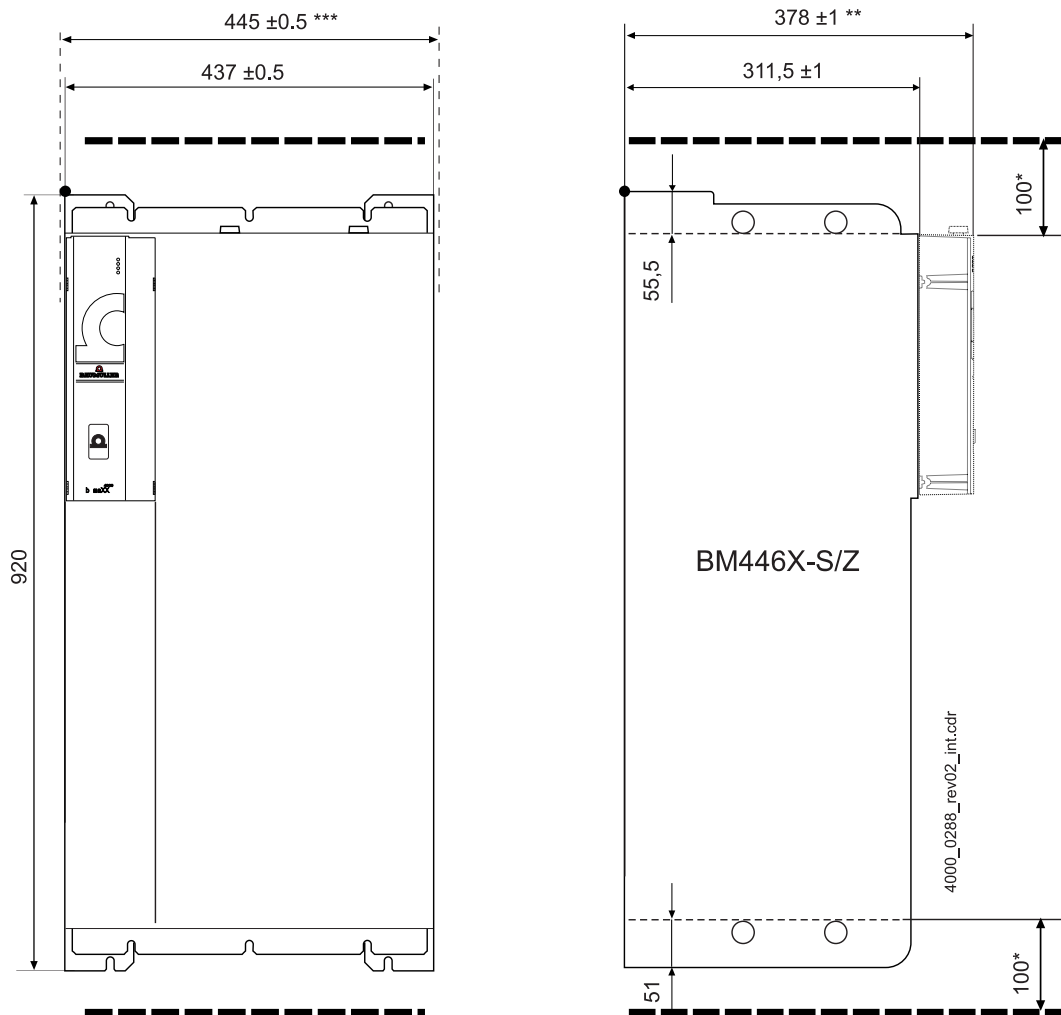

Figure 19: Dimensions BM446X-S/Z

- *: Observe minimum clearance, Observe [Cooling](#) from page 63.
- ** : Dimensions specified with design cover. The ES controller is not equipped with a design cover.
- ***: Width including screw heads.

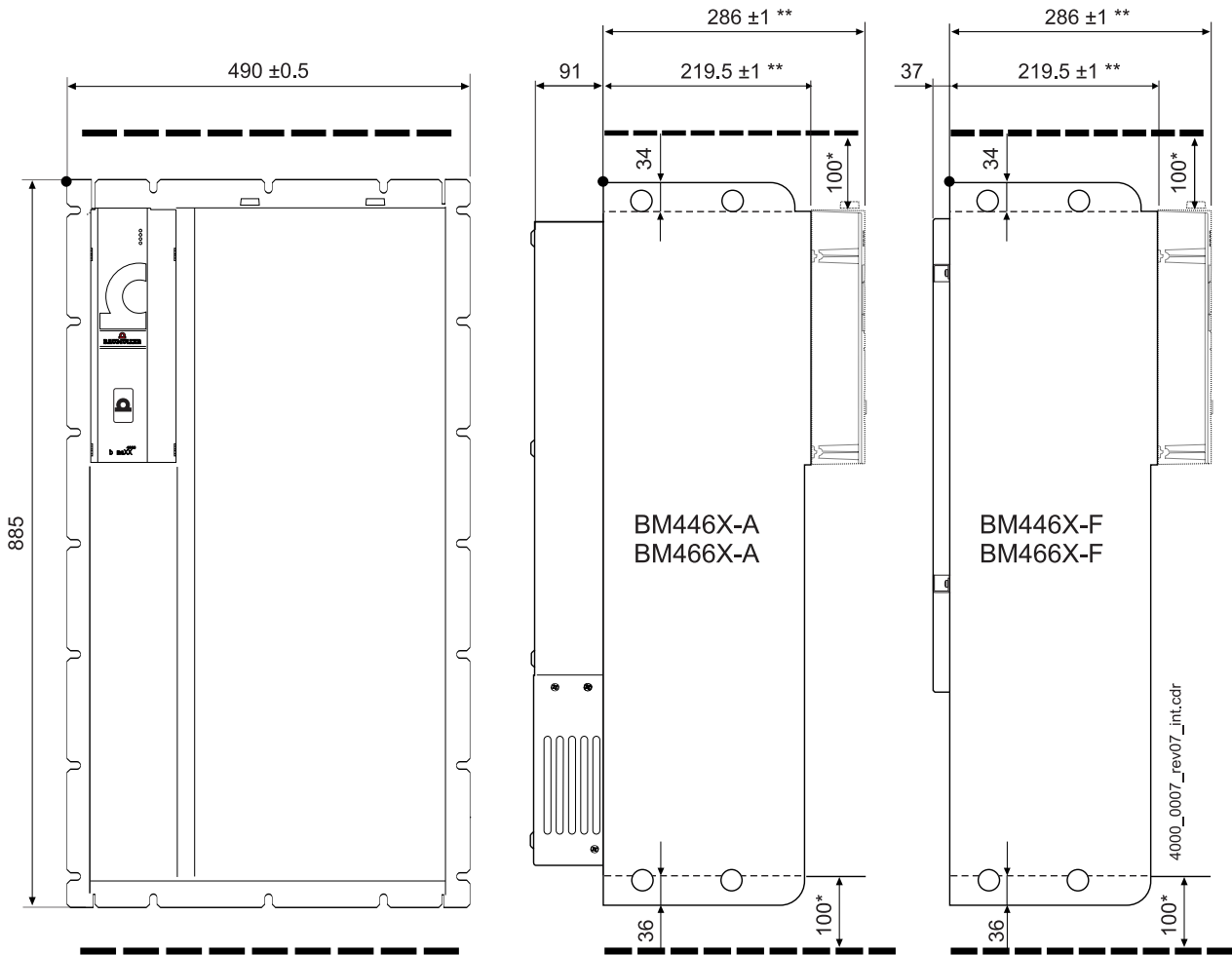

Figure 20: Dimensions BM446X-A/F and BM466X-A/F

*: Observe minimum clearance, Observe [Cooling](#) from page 63.
 **: Dimensions specified with design cover. The ES controller is not equipped with a design cover.
 ***: Width including screw heads

Devices BM4XXX-F... with option brake resistor Ryy: The depth of the cooling part outside the switching cabinet increases by 25 mm.



NOTE!

The device BM4X6X-AX-0XXX was extended by about 80 mm downwards by an additional protective plate against contact.

3.1 Dimensions

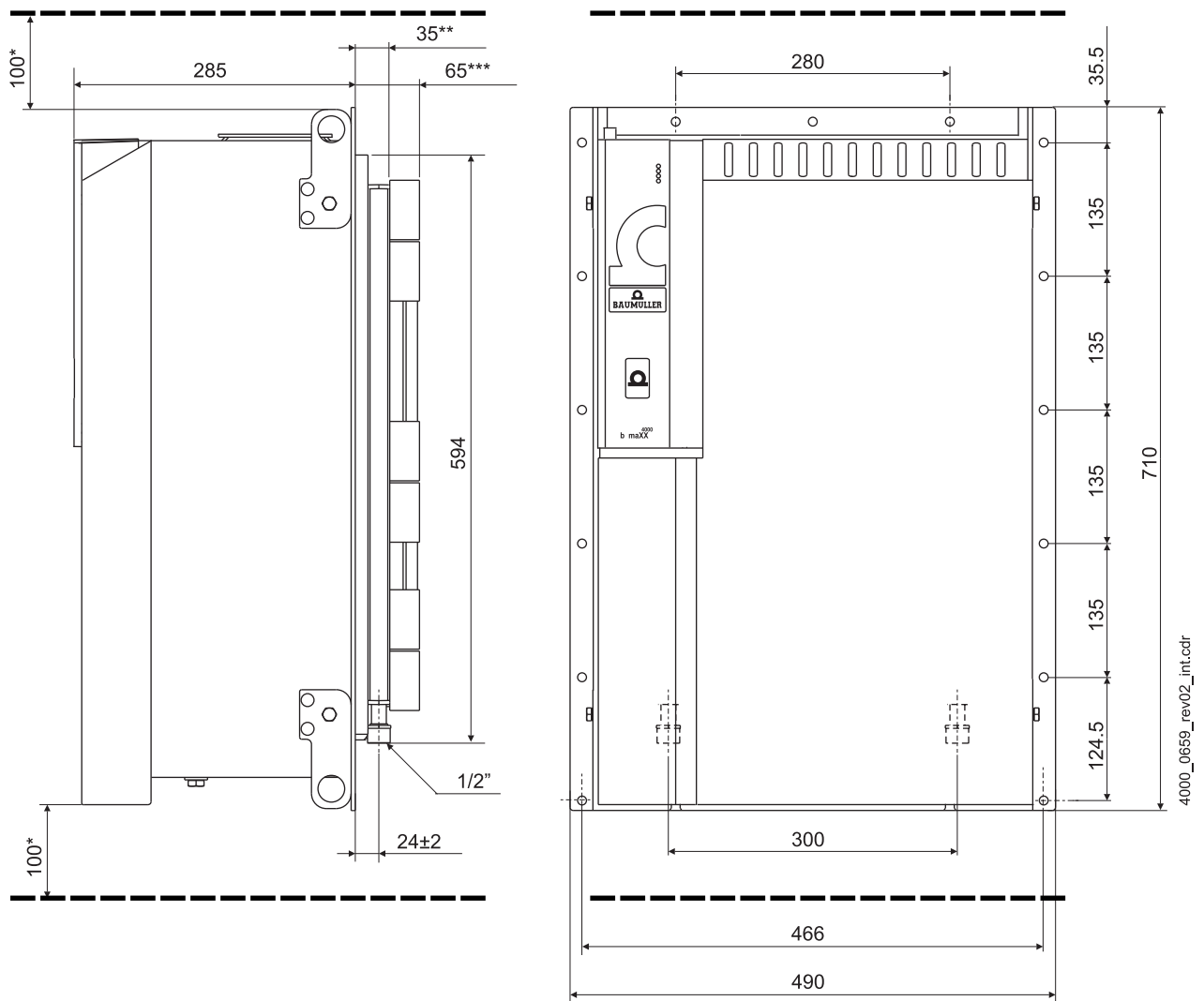

- *: Observe minimum clearance. Observe [Cooling](#) from page 63.
- **.: Devices BM4XXX-F without brake resistor
- ***.: Devices BM4XXX-F with brake resistor Ryy

Figure 21: Dimensions BM466X-FXX-3XXXX and BM476X-FXX-3XXXX

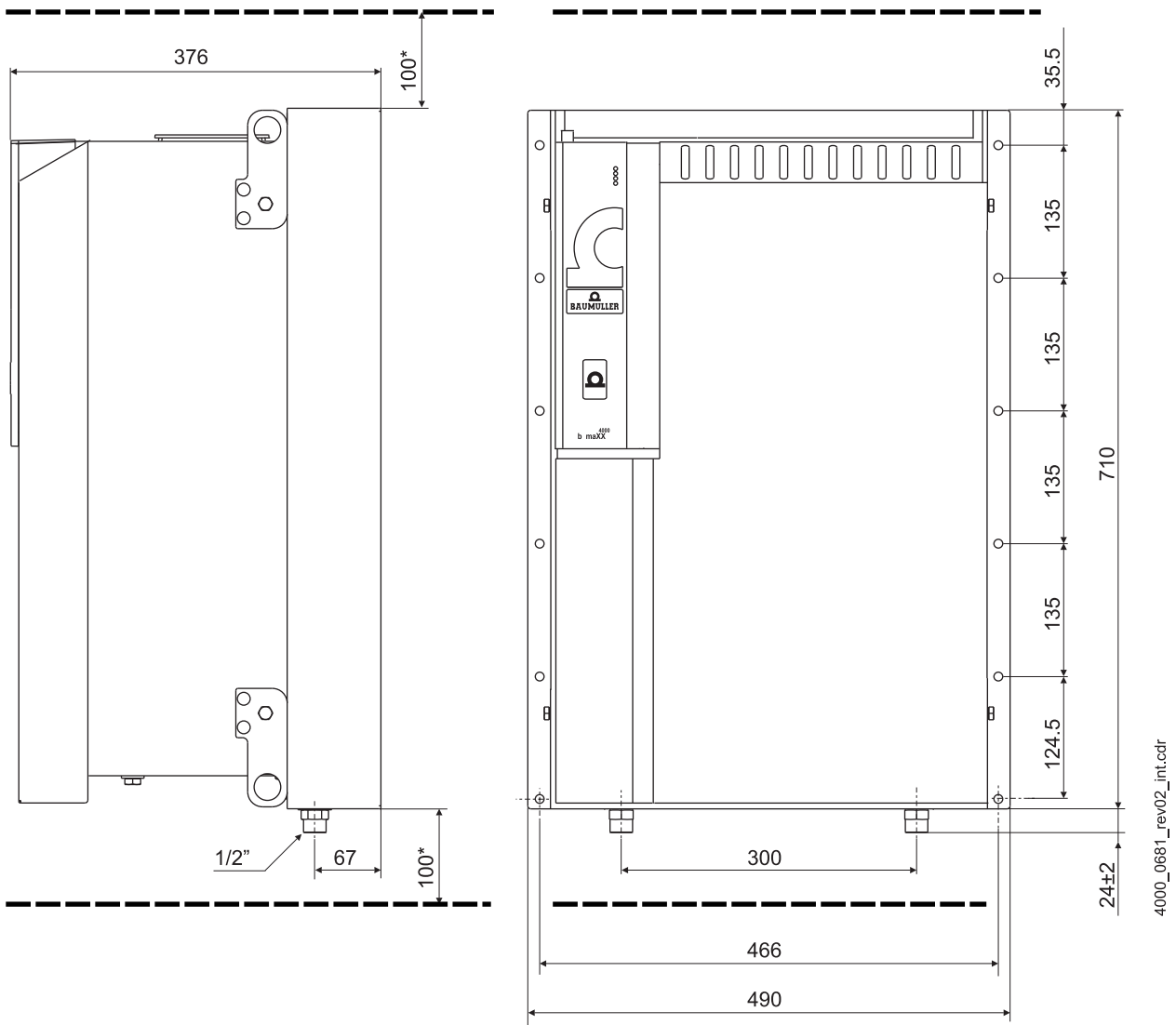

*: Observe minimum clearance. Observe >Cooling< from page 63.

Figure 22: Dimensions BM466X-Z-3XXXX and BM476X-Z-3XXXX

3.1 Dimensions

3.1.7 Dimensions BM4X7X

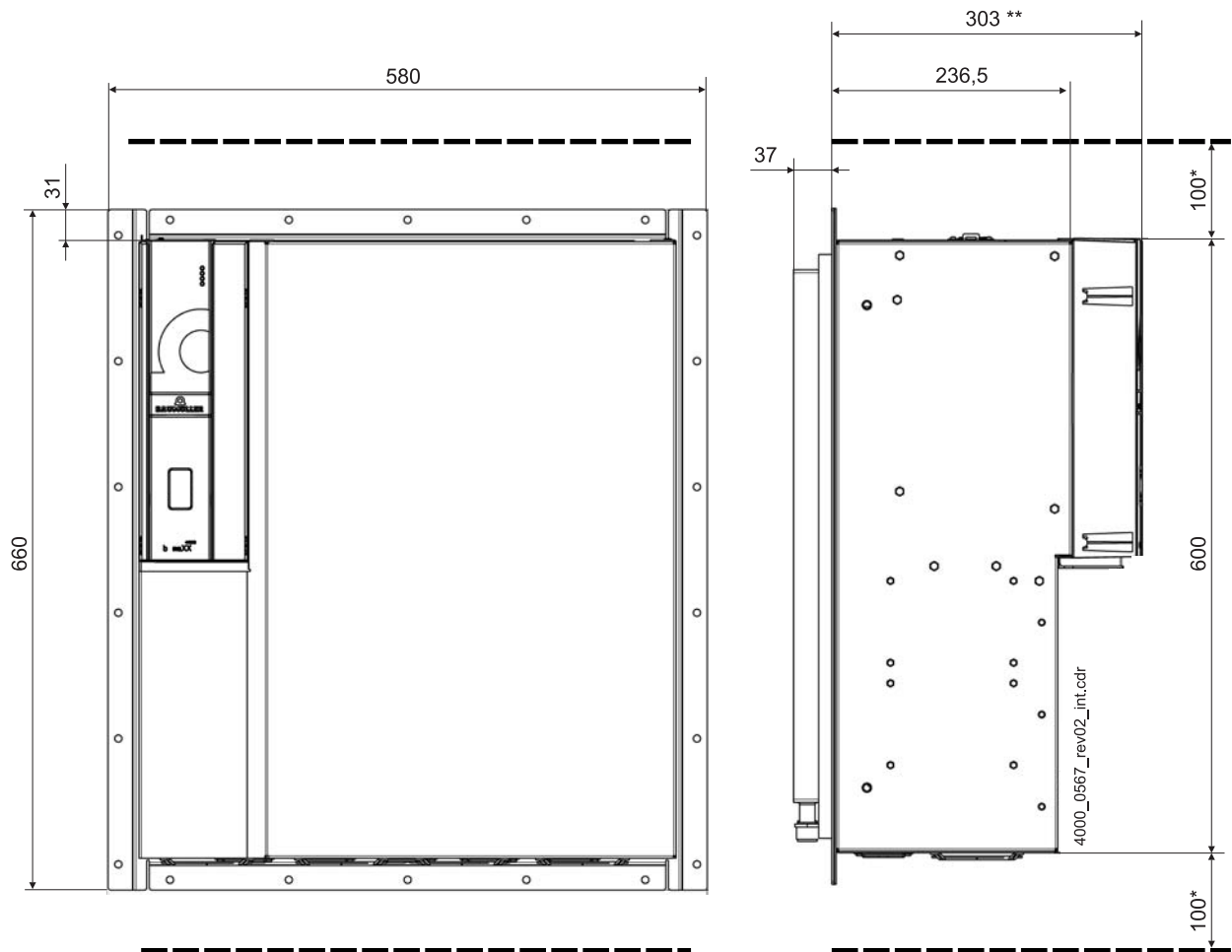
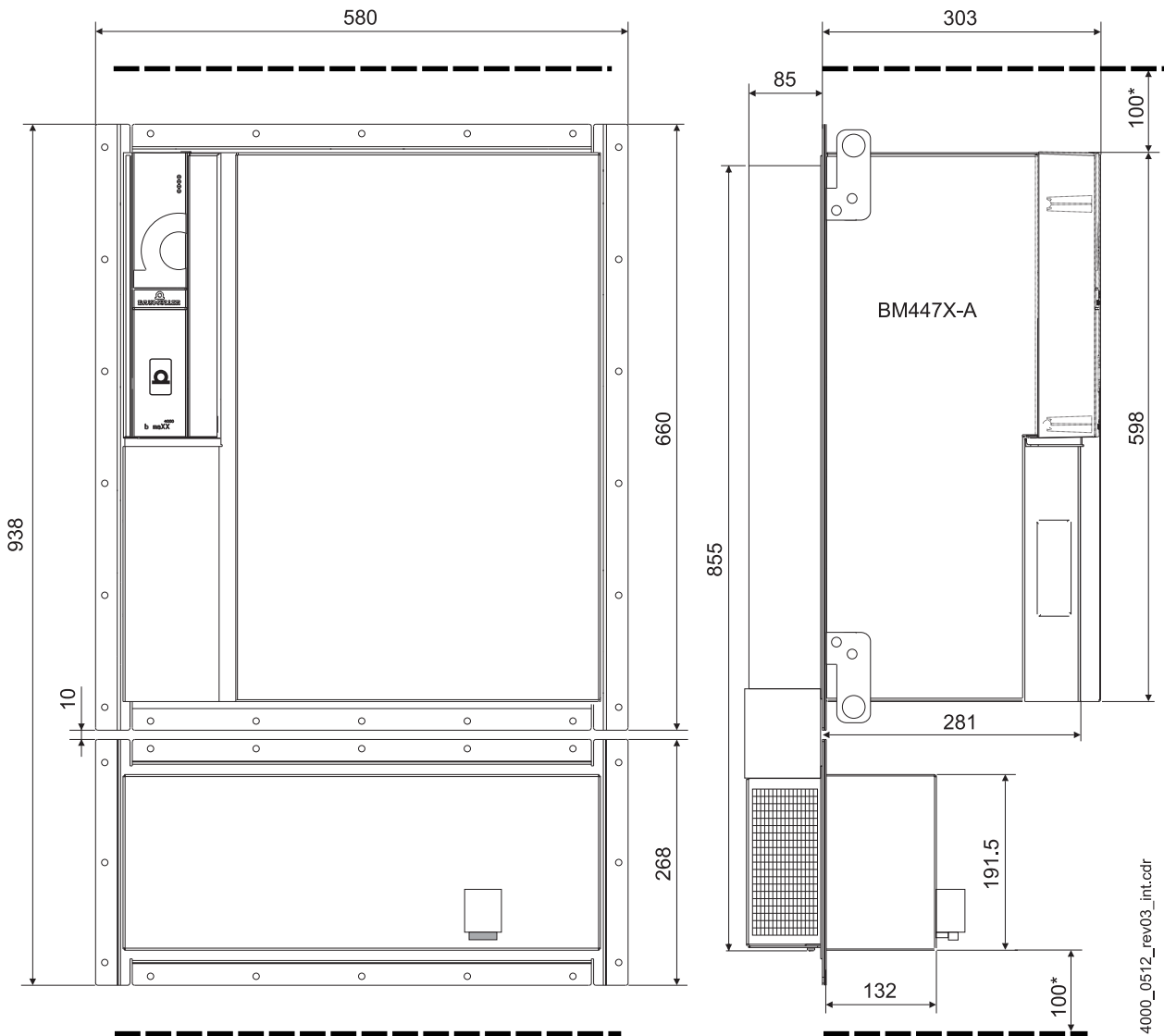

Figure 23: Dimensions BM447X-F, BM477X-F

*: Observe minimum clearance, Observe [►Cooling◄](#) from page 63.

** : Dimensions specified with design cover. The ES controller is not equipped with a design cover.

Devices BM4XXX-F... with option brake resistor Ryy: The depth of the cooling part outside the switching cabinet increases by 25 mm.



4000_0512_rev03_intL.cdr

Figure 24: Dimensions BM447X-A

*: Observe minimum clearance, Observe [▶Cooling◀](#) from page 63.
 **: Dimensions specified with design cover. The ES controller is not equipped with a design cover.

3.2 Weight

Device	Dimensions (W x H x D)	Weight with controller, without plug-in modules
BM441X ¹⁾	80 x 347 x 263 mm 105.5 x 347 x 263 mm	4,0/4,4 kg
BM442X ²⁾	105.5 x 428 x 340 mm	7,0 kg
BM443X ²⁾ BM463X ²⁾	155 x 540 x 340 mm	15,7 kg
BM444X ²⁾ BM464X ²⁾	190 x 665 x 374 mm	26,4 kg
BM445X ²⁾ BM465X ²⁾	304 x 745 x 380 mm	50 kg
BM465X-FXX-3XXXX BM475X-FXX-3XXXX	360 x 604 x 320 mm	35 kg
BM446X ²⁾ BM466X ²⁾	437 x 920 x 380 mm	70 kg
BM466X-FXX-3XXXX BM476X-FXX-3XXXX	490 x 710 x 322 mm	67 kg
BM447X ³⁾ BM477X ³⁾	580 x 660 x 340 mm	82 kg

¹⁾ The first row specifies the dimensions of the devices BM441X-XXX-00XXX-XX and BM441X-XXX-01XXX-XX. The second value specifies the dimensions of the device BM441X-XXX-02XXX-XX.

²⁾ Dimensions and weights for the devices BM44XX-S and BM46XX-S. The deviations of the other cooling versions refer to [►Dimensions◄](#) from page 33.

³⁾ The dimensions for the device BM447X-F and BM477X-FXX-3XXXX are specified. The specified depth is the total depth of the device. Refer to [►Figure 24◄](#) on page 51.

3.3 Operating requirements

3.3.1 System types

There are three basic types of the current supply systems regarding the grounding, which conform with DIN VDE0100 part 300 and IEC 60364:

- The TN system has a directly grounded point (system grounding). The cabinet of the electrical installation is connected via the protective conductors and PE conductors with this point.
- The TT system has a directly grounded point (system grounding). The cabinet of the electrical installation is connected with grounding electrodes. The grounding electrodes are separated from system grounding.
- The IT system has no direct connection between the active conductors (L1, L2, L3, N) and grounded parts (PE). The cabinet of the electrical installation is grounded. The separation is reached by using an isolating transformer or an independent current source (generator, battery).

If the low-impedance ground fault is adequate, an upstream fuse within the TN system or the TT system responds. At a high-impedance ground fault a fuse does not respond. This ground current (residual currents) can be dangerous. Therefore sensitive circuit breakers are used for residual current monitoring.

At a ground fault In an IT system there is no ground current. The upstream fuses do not respond. Therefore the operation procedure is maintained. A second ground fault at another phase leads to residual currents. This can initiate a fuse. In order to detect the first ground fault a ground leakage monitor is required. In order to detect the second ground fault a residual current monitoring is required.

Supported system types



NOTICE!

The operation of the **BM4400, BM4600, BM4700** devices is possible at IT systems and at TN / TT systems.



NOTE!

Certain device types are available in type BM4XXX - XIX only. This devices can be operated on IT, TN/TT systems and grounded delta systems.

3.3 Operating requirements

3.3.2 Requirements to the energy supply / supply system

Supply system (refer to ▶System types◀ from page 53)	BM44XX - XTX ⁶⁾ BM46XX - XTX ⁶⁾ BM47XX - XTX ⁶⁾	Industrial system with a direct grounded neutral point or with a low impedant grounded neutral point (TN system or TT system)
	BM44XX - XIX BM46XX - XIX BM47XX - XIX	Industrial system with a grounded star point (IT-system), which has no or high impedance Industrial system with direct or low impedance earthed phase junctions (grounded delta wye)
Inductance (sum of power supply inductance and choke inductance)	BM441X, BM442X	Min. $u_k = 0.4 \%$ max. $u_k = 4 \%$
	BM4426, BM443X, BM444X, BM463X, BM464X	Min. $u_k = 2.4 \%$ max. $u_k = 4 \%$
	BM445X, BM465X, BM475X, BM446X, BM466X, BM476X, BM447X, BM477X	Min. $u_k = 4 \%$ max. $u_k = 6 \%$
Rated supply voltage/-frequency ^{1) 2)} (U_{AC}) device		3 x 400 V 50/60 Hz
Absolute minimum supply voltage device ^{1) 2)} (U_{AC}) Absolute maximum supply voltage device ^{1) 2)} (U_{AC})		3 x 207 V / 50/60 Hz 3 x 528 V / 50/60 Hz
Absolute minimum frequency ⁵⁾ Absolute maximum frequency ⁵⁾		47 Hz 63 Hz
Overvoltage category EN 61800-5-1, chapter. 4.3.6		III
Harmonics (power supply voltage) EN 61800-3, chapter 5.2.1, chapter 3		$THD_U \leq 12 \%$
Unbalanced power supply voltage EN 61000-2-4, Tab. 1, class 3		Max. 3 %
Commutating dips EN 61800-3, chapter 5.2.1, class 3		Depth of dip < 40 %, area < 250 % x degrees
Voltage dips EN 61800-3:2004 and A1:2012		10 % to 80 % ¹⁾
Voltage variations/-fluctuations EN 61200-2-4, class 3		+/-10 % ⁸⁾ +10 % to -15 % at a period of ≤ 1 min
Short Circuit Current Rating (SCCR) ⁴⁾		65 kA
Prospective short circuit current according EN61800-5-1	BM551X, BM552X, BM553X, BM563X	5 kA
	BM554X, BM564X, BM555X, BM565X, BM575X	10 kA
	BM556X-, BM566X-, BM576X	18 kA
	BM557X-, BM577X	30 kA

Rated supply voltage / -frequency (U_{AC}) fan ⁷⁾	BM444X-S/A, BM445X-S/A, BM446X-S/A, BM464X-S/A, BM465X-S/A, BM466X-S/A	230 V \pm 10 % 50/60 Hz
	BM447X-A	3 x 400 V \pm 10 % 50/60 Hz
Control voltage ³⁾ (U_{DC}) following EN 61131-2:2008		+ 24 V -15 % / +20 %

- 1) Voltage dips of the power supply voltage phase-to-phase down to 0 V are prohibited, no matter how short
The error „power supply not ready-to-operate“ is generated if the supply voltage falls below U_{ACmin} for $t > 0.1$ s.
- 2) Rated voltage is 400 V.
With lower supply voltages the output power of the device is reduced. Refer to correction factors, in case the operating conditions were changed [▶ Supply voltage ◀](#) on page 59.
- 3) The control voltage must accord to PELV (EN 61800-5-1, chapter 3.21) or SELV (EN 61800-5-1, chap. 3.35).
At control voltage of < 24 V the ventilation power output is reduced. Therefore, it may be necessary, to reduce the output currents as well.
- 4) Required for UL 508C, only.
- 5) Rate of change of the power supply frequency 1 Hz/s at a maximum (EN 61000-2-4, class 3).
- 6) The connection and operation of a device with the identification BM4XXX-XTXX at an IT system or a grounded delta system, is **not** permitted.
- 7) Valid for BM444X/BM445X/BM446X/BM464X/BM465X/BM466X cooling versions S and A and BM 447X cooling version A.
- 8) The power supply voltage phase-to-phase must increase or decrease linearly within 800 μ s between zero crossing and 150 V.

3.3.3 Motor requirements

Devices **BM4400**, **BM4600**, **BM4700** are designed to operate three-phase current motors with a terminal motor voltage of 3 x 350 V (typical for servo motors of Baumüller). Devices **BM4400**, **BM4600**, **BM4700** are designed to operate 3 x 400 V (standard asynchronous motors and customer-specific motors of Baumüller). The motors must be operated wye-connected. The rated DC link voltage is 540 V_{DC}. The DC link voltage may rise up to 780 V to 800 V in braking operation. The connected motor must be designed for these DC link voltages.

The DC link voltage remains between 640 V and 760 V continuously (not only in the braking operation), if the **BM4400**, **BM4600**, **BM4700** power modules are operated at a voltage-controlled DC link (e.g. BM51XX). The connected motor must be able to operate at these voltages continuously.

The device can be used at lower voltages, also (e.g. 3 x 230 V). However, here, the three-phase current motors must be designed for the operation with power inverters with up to 800 V DC link voltage, because the brake resistor threshold remains (refer to [►Electrical data basic units◄](#) from page 65). For these reasons three-phase motors with $U_{DC, \text{rated}} \geq 540 \text{ V}$ must be used, only.

3.3.4 Required environmental conditions

Transport temperature range	- 25 °C to + 70 °C
Transport climatic category EN 60721-3-2	2 K 3
Storage temperature range	- 25 °C to + 55 °C
Storage climatic class EN 60721-3-1	1 K 4
Operation environment	Industrial system ¹⁾ Category C2 according EN61800-3 for operation in Second Environment
Operation temperature range	Min. 5 °C to max. 55 °C (with derating above 40 °C) ³⁾
Operation climatic class EN 60721-3-3	3 K 3
Installation altitude	Up to 4000 m above MSL, except BM441X, BM4426 up to 2000 m (with derating above 1000 m) ²⁾
Humidity (operation) EN 60721-3-3	Relative humidity: 5 % to 95 % no condensation and absolute humidity: 1 g/m ³ to 29 g/m ³
Ionizing and non-ionizing radiation	Lower than measurable range
Vibration, shock and repetitive shock EN 61800-5-1, section 5.2.6.4 Vibration test	Max. 1 g during operation
Degree of pollution EN 61800-5-1, table 6, Tab. 2	2

¹⁾ For the operation in an environment of category C2 according to IEC 61800-3:2012, additional measures may be required. The manufacturer of the installation / user must provide the following evidence in this case: The additional measures are effective. The specified limit values of category C2, which are described in IEC 61800-3, are complied with.

²⁾ Refer to correction factors at changed environmental conditions, [▶Installation altitude◀](#) on page 58.

³⁾ Refer to correction factors at changed environmental conditions, [▶Environmental temperature◀](#) on page 59.



NOTICE!

Normally, non-conductive pollution occurs. Conductive pollution is unacceptable. Conductive pollution can lead to the destruction of the device. The customer is responsible for destructions, which were caused by pollution due to conductive materials or components.

3.3 Operating requirements

3.3.5 Correction factors if the operating conditions are changed

If the devices **BM4400**, **BM4600**, **BM4700** are operated at operating conditions, which lead to different correction factors, then all correction factors must be considered by multiplying them simultaneously to calculate the output power and the output current.

The following correction factors are to be considered if nothing other is specified at the „Technical data“ of the device:

3.3.5.1 Installation altitude

If the devices **BM4400**, **BM4600**, **BM4700** are operated above an absolute altitude of 1000 m, then the output power must be reduced against the rated power according to the following curve.

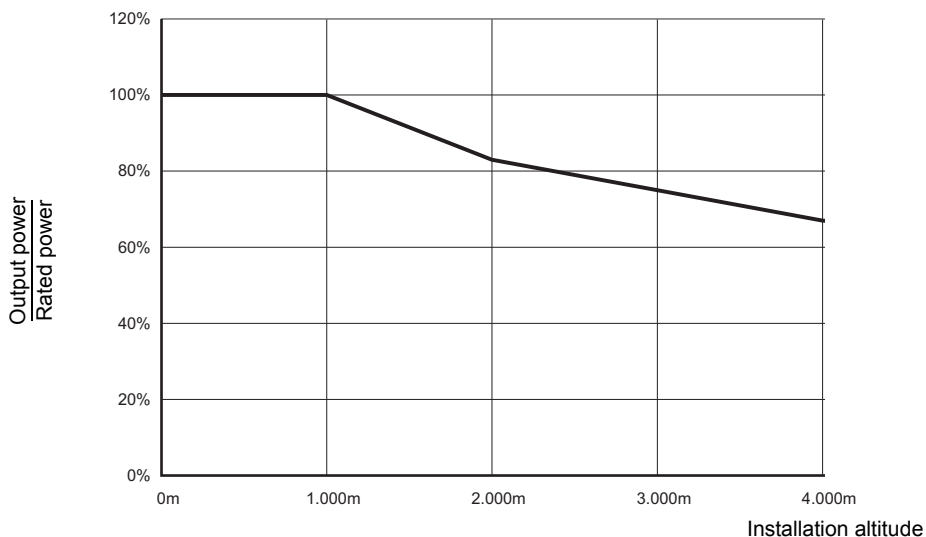

Figure 25: Reducing of the output power in dependence of the absolute altitude



NOTICE!

Devices BM441X and BM4426 have an operating altitude of maximum 2000 m.



NOTE!

Baumüller devices, which are provided for the operation at grounded delta systems or IT supply systems, may have an operating altitude of 2000 m at these systems, only. If the altitude is higher than 2000 m to 4000 m these devices must be operated at TN systems and TT systems. Such systems, e. g. can be achieved by using an isolating transformer with a secondary-sided star point.

3.3.5.2 Environmental temperature

The devices **BM4400, BM4600, BM4700** were designed to be operated at an environmental temperature of $T_{Rated} = 40\text{ °C}$. If the devices are operated at temperatures between 40 °C and 55 °C the permitted output current (I_O) must be reduced according to the following formula:

$$I_O = I_{O(40\text{°C})} \cdot \left(1 - \left(\frac{\text{Coolant temperature} - 40\text{°C}}{\text{°C}} \cdot 0,03\right)\right)$$

The coolant temperature complies with the environmental temperature of air-cooled devices, with the temperature of the water cooler of water-cooled devices and the surface temperature of the cold plate/mounting panel of devices with cold plate cooling.

3.3.5.3 Supply voltage

Above rated supply voltage

The rated voltage is 3 x 400 V

When having input voltages above the rated supply voltage the output currents must accordingly be reduced at a constant output power.

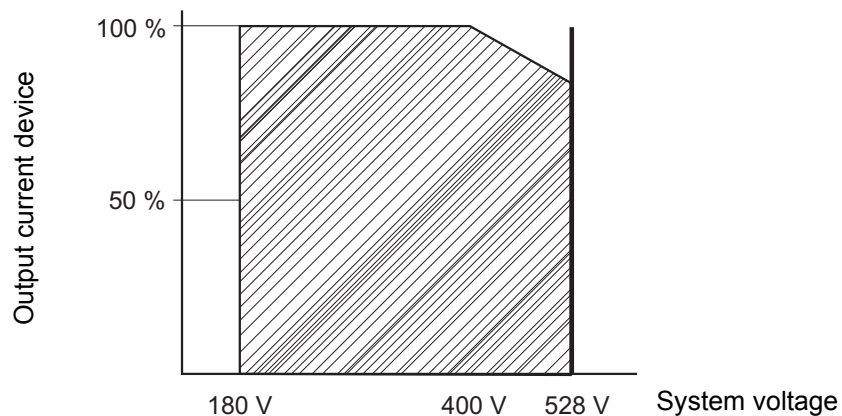

Figure 26: Output current in dependence of the input voltage

3.3 Operating requirements

Below rated supply voltage

The rated voltage is 3 x 400 V

The output power of the device reduces with lower system voltages.

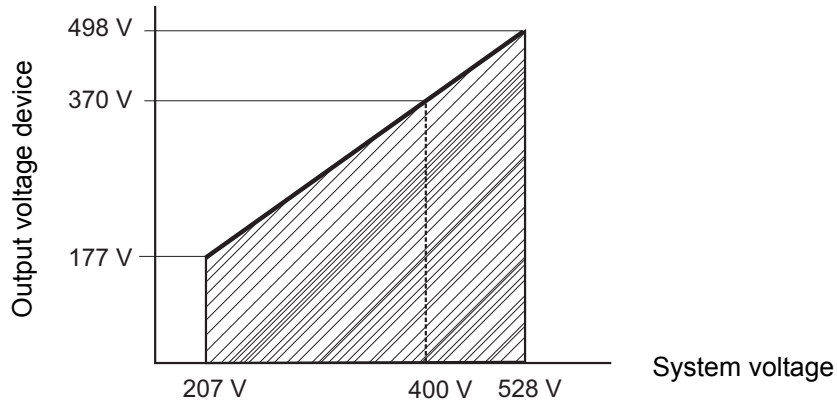

Figure 27: Reducing the output voltage in dependence with the input voltage

Output power

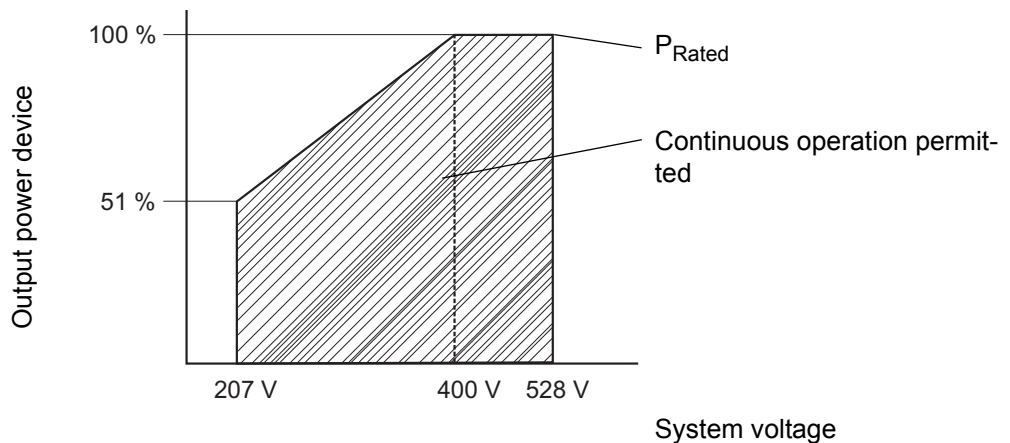

Figure 28: Reducing the output power in dependence of the system voltage

The output power of the device is obtained by multiplying the output current with the output voltage.

$$S_{\text{Out}} = U_{\text{Out}} \times I_{\text{Out}} \times \sqrt{3}$$

It is necessary to reduce the output current to a value between 400 V and 528 V, in order to obtain the specified curve / surface.

3.3.6 Coherence between rated current and peak current

- Calculation of the thermal RMS current from the dimensioning cycle

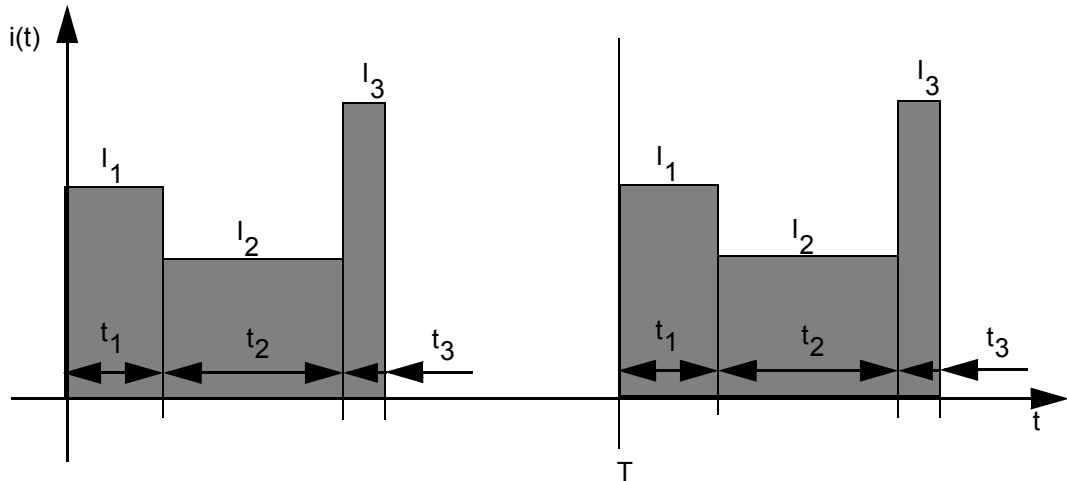

Figure 29: Calculation of the thermal RMS current

$$I_{\text{eff}} = \sqrt{\sum_{n=1}^k I_n^2 \cdot \frac{t_n}{T}} = \sqrt{I_1^2 \cdot \frac{t_1}{T} + I_2^2 \cdot \frac{t_2}{T} + I_3^2 \cdot \frac{t_3}{T}}$$

- Coherence between peak current and rated current for the dimensioning of a motion cycle

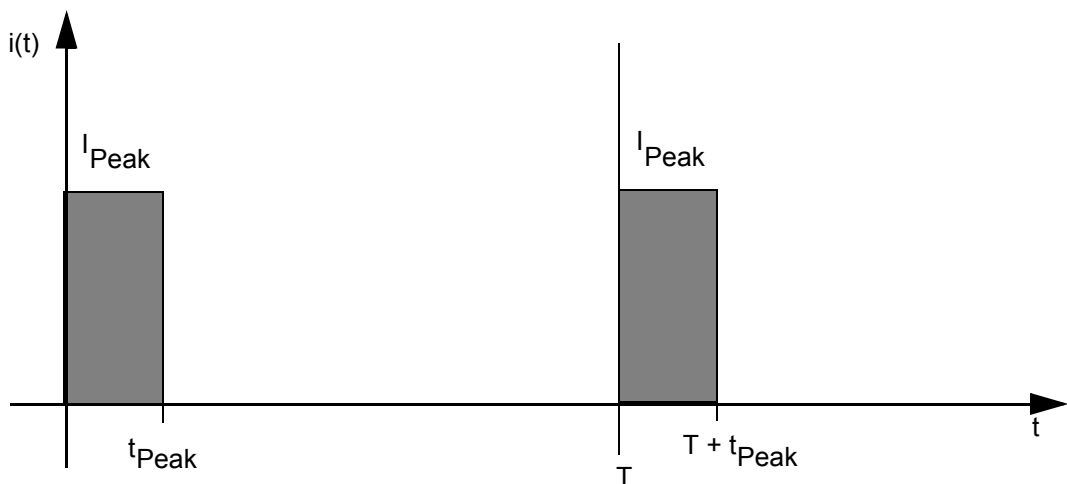

Figure 30: Coherence between peak current and rated current

$$\frac{t_{\text{Peak}}}{T} = \left(\frac{I_{\text{Rated}}}{I_{\text{Peak}}} \right)^2$$

3.3 Operating requirements

- Coherence between peak current of drive and the braking peak current

Assumptions: $P_{\text{Shaft, Acceleration}} = P_{\text{Shaft, Braking}}$, $\cos \varphi_{\text{Acceleration}} = \cos \varphi_{\text{Braking}}$

$$\frac{I_{\text{max,Phase,Acceleration}}}{I_{\text{max,Phase,Braking}}} = \frac{U_{\text{DC link, Braking}}}{U_{\text{DC link, Acceleration}}} \left(\frac{1}{\eta_{\text{Motor}}} \right)^2$$

Typical values:

$$U_{\text{DC link, Braking}} = 780 \text{ V}$$

$$U_{\text{DC link, Acceleration}} = 540 \text{ V}$$

$$\eta_{\text{Motor}} = 0.9$$

Typically resulting in:

$$I_{\text{max,Phase,Braking}} = 0.56 \cdot I_{\text{max,Phase,Acceleration}}$$

3.3.7 Cooling

Cooling air temperature ¹⁾ (rated temperature: 40 °C)	Min. 0 °C to max. 55 °C, see ►Environmental temperature◄ on page 59
Cooling air requirement ²⁾	Refer to ►Electrical data basic units◄ from page 65
Temperature water cooler ⁵⁾ (rated temperature: 40 °C ⁹⁾)	Min. internal temperature to max. 55 °C, see ►Environmental temperature◄ on page 59
Cooling water flow rate ^{4) 8)}	
BM443X, BM444X, BM445X, BM446X	Min. 4 l/min. up to max. 15 l/min.
BM463X, BM464X, BM465X, BM466X	Min. 4 l/min. up to max. 15 l/min.
BM465X-FXX-3XXXX, BM466X-FXX-3XXXX, BM4755, BM4766	Min. 10 l/min. up to max. 15 l/min
BM457X, BM477X	Min. 15 l/min. up to max. 25 l/min.
Cooling water pressure	Max. 6 bar ³⁾
Cooling water hysteresis	Max. 5 K in the static and the dynamic operation
Hot water heating (cooling water inlet to cooling water outlet) ⁴⁾ [K]	$< 14.35 \left[\frac{\text{l/min}}{\text{kW}} \cdot \text{K} \right] \cdot \frac{\text{Powerloss}[\text{kW}]}{\text{Cooling water flow} [\text{l/min}]}$
Pressure loss at the water cooler	0.5 bar at 10 l/min
Mounting board temperature with cold plate ^{5) 6)} (rated temperature: 40 °C)	Min. internal temperature to max. 55 °C at water cooling ⁷⁾ : water outlet temperature 40 °C surface temperature 42 °C

1) Air temperature in the entire suction area of the device.

2) The cooling air requirement corresponds at least to that of a free-blowing device. Free-blowing means, that the air inlet and the air outlet operates unrestricted. With the mounting of the device into a control cabinet it therefore can be necessary to use additional fans, so that the necessary cooling air requirement is covered. If the necessary cooling air requirement of the power heat sink is not provided, then the output power of the device has to be reduced.

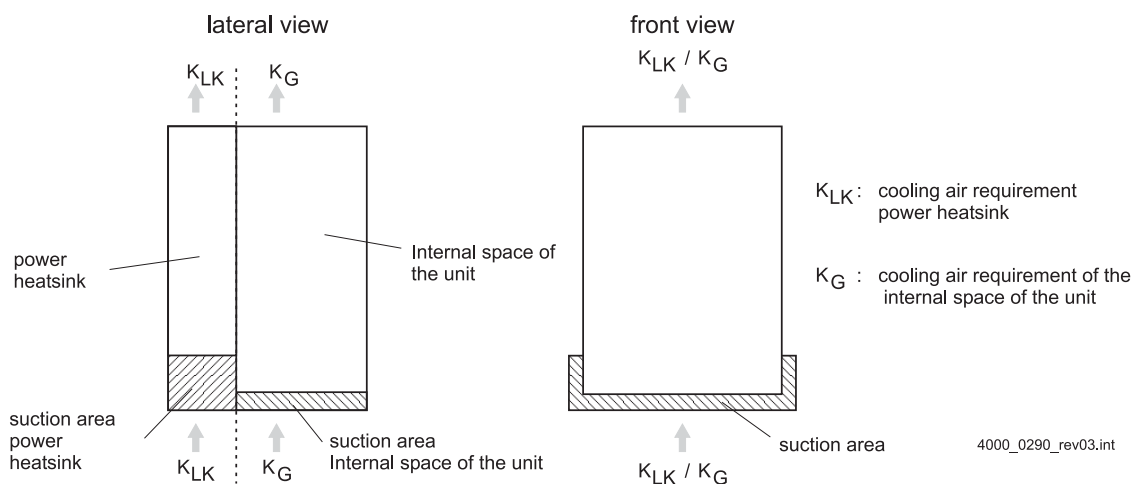

Figure 31: Cooling air requirement

3) In case you refer to UL508C: max. 3 bar. There must be a pressure-relief valve with a threshold pressure of maximum 6 bar in the cooling circulation.

3.3 Operating requirements

4) Rated flow = 10 l/min

If you have other cooling water flow rates than the ones, which were mentioned above, please contact Baumüller Nürnberg GmbH.

The cooling water must meet the following requirements:

pH-value	6.5... 9.5	Manganese (Mn)	< 0.05 ppm
Conductivity	50... 600 µS/cm	Copper (Cu)	< 0.1 ppm
Water hardness (inclusive CaCO ₃)	< 100 ppm	Chlorine (Cl ₂)	< 1 ppm
Suspended matters	< 10 ppm	Chloride (Cl ⁻)	< 500 ppm
Particle size	< 100 µm	Sulfate (SO ²⁻⁴)	< 500 ppm
Ryznar Stability Index (RSI)	5.0 ... 6.0		

The corrosion-resistant compared with further materials you can take from the DECHEMA-material tables.

Use a corrosion-resistant and a closed cooling circuit.

5)



The surface temperature of the water cooler or cold plate outside the cabinet must be higher or the same as the device interior temperature (measured heatsink temperature of the device) to prevent condensation always.

In case of surface temperatures other than those specified, please inquire with Baumüller Nürnberg GmbH.

6) Notes relating to cold plate



The cooling version cold plate is a particular efficient cooling alternative. The heat dissipation is done via 2 contact surfaces. The mounting platform within the control cabinet or on the machine base is one, the device, to be cooled is mounted there. High requirements e.g. to surface roughness and evenness for this surface are specified, to ensure an optimal heat flow. Already a slight damage/pollution of the surface can cause a significant deterioration in heat dissipation to the mounting plate.

For this reason while handle the units protect the sensitive function surface to avoid damage and pollution.

7) By means of the thermal resistance of the cooling system and the thermal power loss, which is supplied to the cooling system, the surface temperature can be calculated.

8) At BM44XX - FXX, BM44XX - ZXX, BM46XX - FXX -0XXXX, BM46XX - FXX - 3XXXX and BM47XX - FXX - 3XXXX, only



NOTE!

Instead of a continuous flow of the water coolers, it is possible to operate with a temperature-controlled, switched water supply. In this case the customer must install a control equipment, so that the flow of the water can be enabled or avoided. This control equipment must read and process the available value „heat sink temperature“ in the controller. It is recommended to enable water flow, if 58 °C were reached. The water flow also must be possible to be stopped if it reached 57 °C. The maximum permitted hysteresis of 5 K. Therefore, the closing temperature can be set to 60 °C and the opening temperature to 55 °C. It is advantageous to set the hysteresis lower, as the controller is a free parameterizable 2-point controller. The integrated 2-point controller can now directly access the variable „heat sink temperature“.

The temperature controlled, switched water supply is able to use water, which is significantly colder. The 2-point hysteresis control of the heat sink temperature avoids impermissible condensation. This way, more power can be emitted via the heat sink. This is advantageous, if water-cooled devices are used, which have an additionally integrated brake resistor (refer to [►Additional data referring to water-cooled brake resistors◄](#) from page 110).

Contact the local Baumüller office for support concerning configuration of alternative cooling water temperature control.

9) The water temperature must be between 5 °C and 75 °C. The output power must be reduced in case of water temperature above 40°C. Water temperatures up to 50 °C are allowed without derating when using devices **without** water-cooled brake resistors.

3.4 Electrical data basic units

3.4.1 Electrical data of the universal units

3.4.1.1 Electrical data BM441X universal units

	BM4412- XTX	BM4413- XTX	BM4414- STX ⁹⁾	BM4414- CTX ⁸⁾⁹⁾
Rated input power ¹⁾	1.9 kVA	3.3 kVA	5.1 kVA	6.9 kVA
Rated input rated current ¹⁾ (I_{eff})	2.8 A	4.8 A	7.3 A	10.0 A
Total harmonic distortion input current ¹⁾ (THD _I)	119 %	110 %	109 %	113 %
Max. input current (I_{eff})	5.2 A	9.0 A	20.0 A	20.0 A
DC link rated voltage ¹⁾ (U_{DC})	540 V _{DC}			
DC link capacitance (internal)	110 μF	240 μF	330 μF	330 μF
DC link discharge time (internal DC link capacitance)	80 s	175 s	240 s	240 s
DC link capacitance (external), permitted	Refer to ▶Figure 33◀ on page 67			
Capacitance DC link to PE	22 nF			
Period between two power up processes ¹²⁾	At least 60 s			
Output voltage ¹⁾²⁾ (U_{AC})	3 x 0 V to 3 x 370 V			
Output frequency at 4 kHz ¹²⁾	0 Hz to 450 Hz			
Rated output current ¹⁾⁴⁾⁵⁾⁶⁾¹³⁾ (I_{AC}) at 4 kHz ³⁾	2.5 A	4.5 A	5.5 A	7.5 A
Rated output current ¹⁾⁴⁾⁵⁾⁶⁾¹³⁾ (I_{AC}) at 8 kHz ³⁾	2.5 A	4.5 A	5.0 A	5.0 A
Output peak current ¹⁾⁴⁾⁵⁾⁷⁾¹³⁾ (I_{AC}) at 4 kHz ³⁾	5.0 A	9.0 A	20.0 A	20.0 A
Output peak current ¹⁾⁴⁾⁵⁾⁷⁾¹³⁾ (I_{AC}) at 8 kHz ³⁾	5.0 A	9.0 A	12.0 A	12.0 A
Max. peak current period ⁷⁾	60 s		1 s	
Connected load DC link terminals ¹⁰⁾	Max. 2.0 kW		Max. 3.0 kW	Max. 4.3 kW
Brake resistor current, permitted (\hat{I})	Max. 5.9 A		Max. 12.0 A	
Brake resistor external	≥ 130 Ω		≥ 65 Ω	
Brake resistor threshold (\hat{U})	780 V			
Brake resistor peak power	4.5 kW	5.0 kW	9.4 kW	9.4 kW
Permitted continuous power brake resistor external	1.0 kW	1.5 kW	3.0 kW	3.0 kW
Power loss referring to power input	33 W	60 W	80 W	102 W
Power input referring to control voltage	Max. 60 W			
Current of the integrated brake control	Max. 2 A			

3.4 Electrical data basic units

- 1) The rated value refer to a DC link voltage of 540 V, a control voltage of 24 V and an environmental temperature of 40 °C.
- 2) The output voltage is a pulsed DC voltage. The operating range refers to the RMS value of the fundamental wave.

$$U_{AC} = 3 \times 0 \text{ V to } 3 \times \left(\frac{U_{DC}}{\sqrt{2}} - 10 \text{ V} \right) \text{ without overmodulation of PWM}$$

- 3) Switching frequency of the inverter (adjustable).
- 4) RMS value at an environmental temperature of 40 °C.
- 5) At a rated supply voltage the unit provides rated output currents and maximum output currents. At input voltages above the rated supply voltage the output currents at constant output power have to be reduced accordingly.

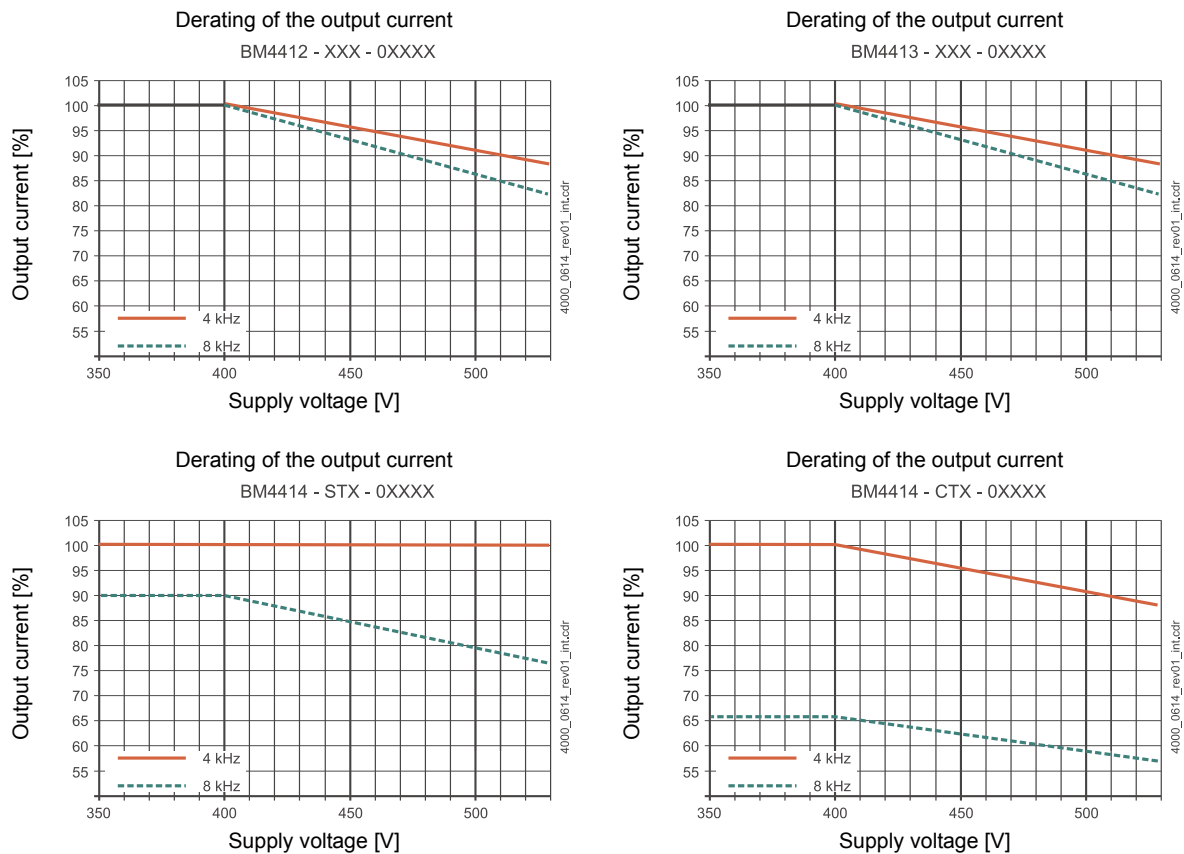

Figure 32: Derating of output current BM441X universal units

- 6) Between 40° C and 55° C the output current must be reduced. Refer to correction factors at changed operating conditions [▶Environmental temperature◀](#) on page 59.
- 7) The peak output current is supplied for the maximum peak current period for the motor at the first acceleration (cold power unit). The in fact possible overload time is dependent on the preload of the device and on the heat sink temperature, it is determined by the overload monitoring of the device.
- 8) These values are specified for the mounting to a heat-conducting surface with a thermal resistance of 0.115 K/W. The maximum permitted temperature of the cabinet at the measuring point is 75 °C. Refer to [▶Figure 86◀](#) on page 188.
- 9)



NOTE!

There are other peak current limits, if BM4414 is in braking operation, only. The following peak currents are possible: 15 A at 4 kHz switching frequency and 10 A at 8 kHz switching frequency

- 10) The sum of the mean effective power transfer via the DC link terminals and at the motor terminals, may not exceed continuously the rated input power of the device. In addition the mean effective power transfer via the DC link terminals to further devices is limited to the specified value.
- 11) The specified value is valid only, if no additional DC link capacitance is connected to the DC link terminals. Refer to [Power on switching frequency / DC link charging](#) on page 231 and [Figure 33](#) on page 67.

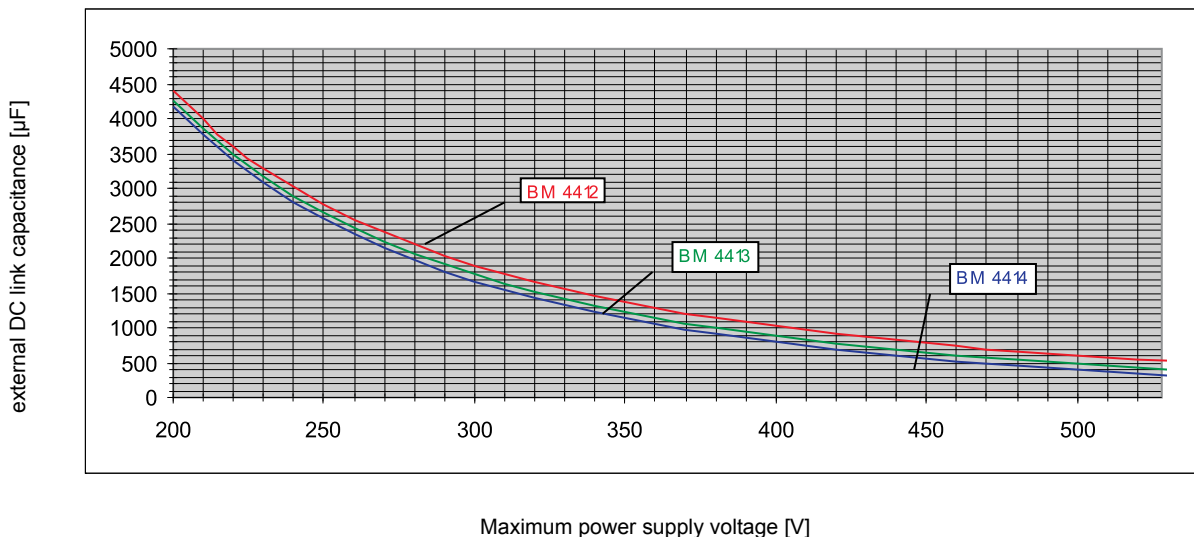

Figure 33: Maximum external DC link capacitance BM441X

- 12) The range of the output frequency is based on a stationary operation in the linear range of the PWM, i. e. without overmodulation. The quality of the generated output voltages depends on the ratio between output frequency and current controller frequency f_{I-R} ($f_{I-R} = 1/\text{cycle time current controller}$). The maximum output frequency f_{max} , generated with high quality, is calculated as follows:

$$f_{max} = \frac{f_{I-R}}{K_{pf}}, \text{ typical } K_{pf} \approx 18$$

Furthermore the controller sets an upper limit for the output frequency of 599 Hz (please contact the responsible Baumüller sales department, keyword: export restriction).

The range of the output frequency is defined as follows:

PWM frequency	Current controller cycle time	Range of the output frequency
2 kHz	250 µs	0 - 225 Hz
4 kHz/8 kHz	125 µs	0 - 450 Hz

The controller allows the device to generate output voltages with frequencies between f_{max} and 599 Hz. However the quality of this voltages cannot be guaranteed.

Typical the devices are marked with the max output frequency at 4 kHz switching frequency: 0 ... 450 kHz.

- 13) The continuously permitted output current must be reduced complying with [Output frequency dependent continuous current derating BM4XXX](#) on page 116, if the statical output frequency is lower than 15 Hz and the frequency remains between 0 and 15 Hz for over 5 seconds.

3.4 Electrical data basic units

3.4.1.2 Electrical data BM442X universal units

	BM4422	BM4423	BM4424
Rated input power ¹⁾	5.6 kVA	8.6 kVA	11.8 kVA
Rated input current ¹⁾ (I _{eff})	8.1 A	12.4 A	17.0 A
Total harmonic distortion input current (THD) ¹⁾	107 %	109 %	109 %
Max. input current (I _{eff})	15.1 A	23.2 A	31.8 A
Rated DC link voltage ¹⁾ (U _{DC})	540 V _{DC}		
DC link capacitance (internal)	470 μF		705 μF
DC link discharging time (internal DC link capacitance)	340 s		510 s
DC link capacitance (external), permitted	Refer to ▶Figure 35◀ on page 71		
Capacitance DC link to PE	22 nF		
Period between two power up processes ⁹⁾	At least 60 s		
Output voltage ¹⁾³⁾ (U _{AC})	3 x 0 V to 3 x 370 V		
Output frequency at 4 kHz ¹¹⁾	0 Hz to 450 Hz		
Rated output current ¹⁾⁵⁾⁶⁾⁷⁾ (I _{AC})	at 4 kHz ⁴⁾	7.5 A	11.0 A
Rated output current ¹⁾⁵⁾⁶⁾⁷⁾ (I _{AC})	at 8 kHz ⁴⁾	6.0 A	8.8 A
Output peak current ¹⁾⁵⁾⁶⁾⁸⁾ (I _{AC})	at 4 kHz ⁴⁾	15.0 A	22.0 A
Output peak current ¹⁾⁵⁾⁶⁾⁸⁾ (I _{AC})	at 8 kHz ⁴⁾	12.0 A	17.6 A
Max. peak current period ⁸⁾	60 s		
Connected load DC link terminals ¹⁰⁾	Max. 5.0 kW		
Brake resistor current, permitted (Î)	Max. 9.0 A	Max. 13.0 A	Max. 18.0 A
Brake resistor external	≥ 86 Ω	≥ 60 Ω	≥ 44 Ω
Brake resistor threshold (Û)	780 V		
Brake resistor peak power	7 kW	10 kW	14 kW
Permitted continuous power brake resistor external	3.4 kW	5 kW	6.8 kW
Power loss referring to power input	102 W	150 W	204 W
Power input referring to control voltage	Max. 63 W		
Current of the integrated brake control	Max. 2 A		
Cooling air requirement internal space	39 m ³ /h	56 m ³ /h	

	BM4425	BM4426- XTX	BM4426- XTX-XXX85
Rated input power ¹⁾	11.8 kVA	13.2 kVA ²⁾	16.6 kVA ²⁾
Rated input current ¹⁾ (I _{eff})	17.0 A	19.0 A ²⁾	24.0 A ²⁾
Total harmonic distortion input current (THD) ¹⁾	109 %	54 % ²⁾	
Max. input current (I _{eff})	34.0 A	37.0 A ²⁾	
Rated DC link voltage ¹⁾ (U _{DC})	540 V _{DC}		
DC link capacitance (internal)	705 μF	1020 μF	
DC link discharging time (internal DC link capacitance)	510 s	695 s	
DC link capacitance (external), permitted	Refer to ►Figure 35◄ on page 71		
Capacitance DC link to PE	22 nF		
Period between two power up processes ⁹⁾	At least 60 s		
Output voltage ¹⁾³⁾ (U _{AC})	3 x 0 V to 3 x 370 V		
Output frequency ¹¹⁾	0 Hz to 450 Hz		
Rated output current ¹⁾⁵⁾⁶⁾⁷⁾ (I _{AC})	at 4 kHz ⁴⁾	15.0 A	22.5 A ¹²⁾ 27.0 A ¹²⁾
Rated output current ¹⁾⁵⁾⁶⁾⁷⁾ (I _{AC})	at 8 kHz ⁴⁾	12.0 A	18.0 A ¹²⁾ 21.6 A ¹²⁾
Output peak current ¹⁾⁵⁾⁶⁾⁸⁾ (I _{AC})	at 4 kHz ⁴⁾	40.0 A	45.0 A ¹²⁾
Output peak current ¹⁾⁵⁾⁶⁾⁸⁾ (I _{AC})	at 8 kHz ⁴⁾	32.0 A	36.0 A ¹²⁾
Max. peak current period ⁸⁾	1 s	8 s	25 s
Connected load DC link terminals ¹⁰⁾	Max. 5.0 kW		
Brake resistor current, permitted (Î)	Max. 25.0 A		
Brake resistor external	≥ 32 Ω		
Brake resistor threshold (Û)	780 V		
Brake resistor peak power	20 kW		
Permitted continuous power brake resistor external	6.8 kW		
Power loss referring to power input	204 W	300 W	350 W
Power input referring to control voltage	Max. 63 W		
Current of the integrated brake control	Max. 2 A		
Cooling air requirement internal space	56 m ³ /h		

1) All rated values refer to a DC link voltage of 540 V, a control voltage of 24 V and an environmental temperature of 40 °C.

2) Using the power choke listed in ►Power chokes◄ on page 306 at a power supply with U_{K,power supply} = 0.4 %.

3) The output voltage is a pulsed DC voltage. The operating range refers to the RMS of the fundamental wave.

$$U_{AC} = 3 \times 0 \text{ V to } 3 \times \left(\frac{U_{DC}}{\sqrt{2}} - 10 \text{ V} \right) \text{ without overmodulation of the PWM.}$$

3.4 Electrical data basic units

- 4) Switching frequency of the inverter (adjustable).
- 5) RMS at an environmental temperature of 40 °C.
- 6) At rated input supply voltage the device supplies the rated- / maximum output currents. At input voltages above the rated supply voltage the output currents at constant output power have to be reduced, accordingly.

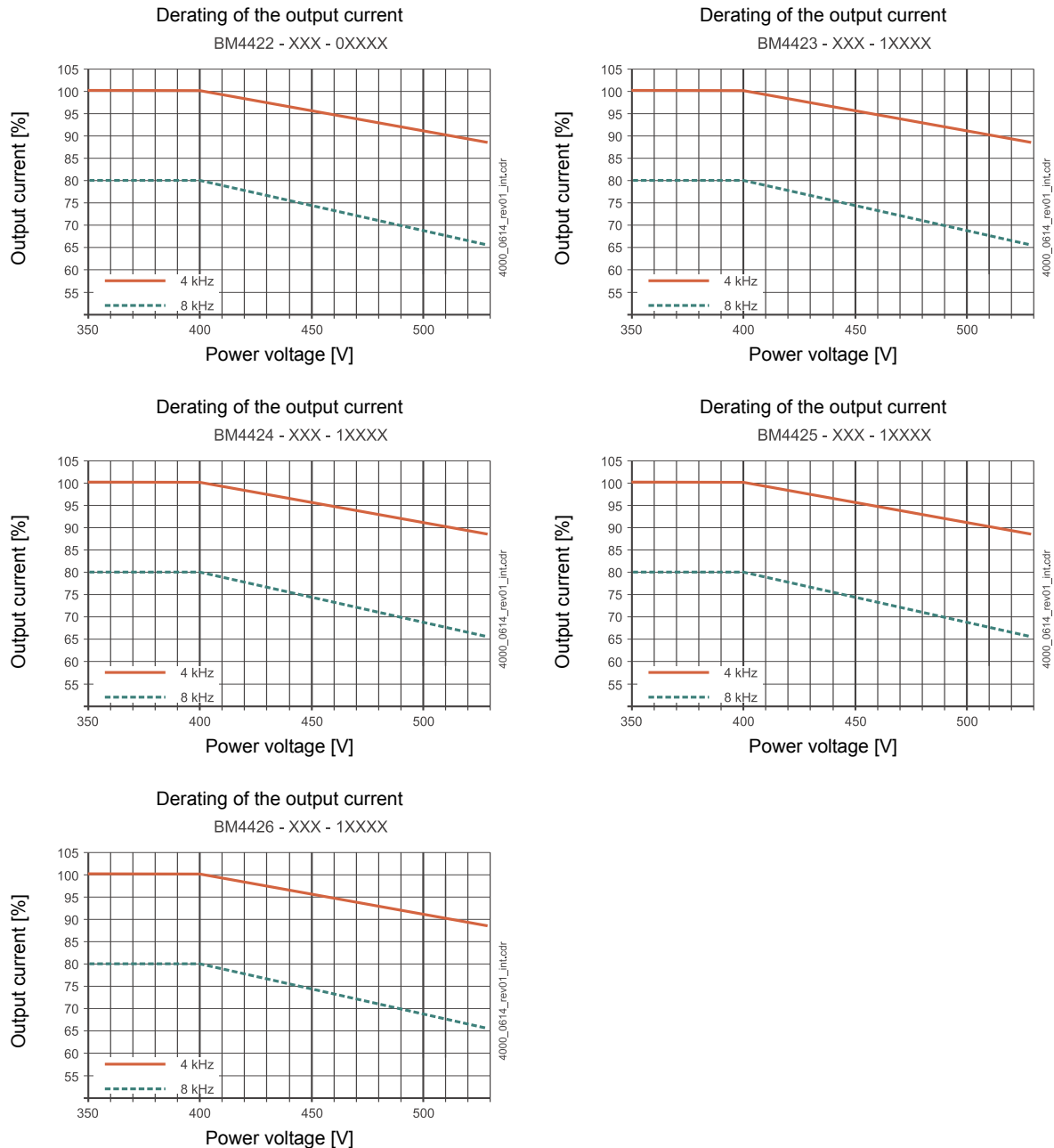

Figure 34: Derating the output current BM442X universal units

- 7) The input current must be reduced between 40 °C and 55 °C, refer to correction factors at changed operating conditions [▶ Environmental temperature ◀](#) on page 59.
- 8) The peak output current is supplied for the maximum peak current period for the motor at the first acceleration (cold power unit). The in fact possible overload time is dependent on the preload of the device and on the heat sink temperature, it is determined by the overload monitoring of the device.

- 9) The specified value is only valid, if there is no additional DC link capacitance connected to the DC link terminals. Refer to [Power on switching frequency / DC link charging](#) on page 231 and [Figure 35](#) on page 71.

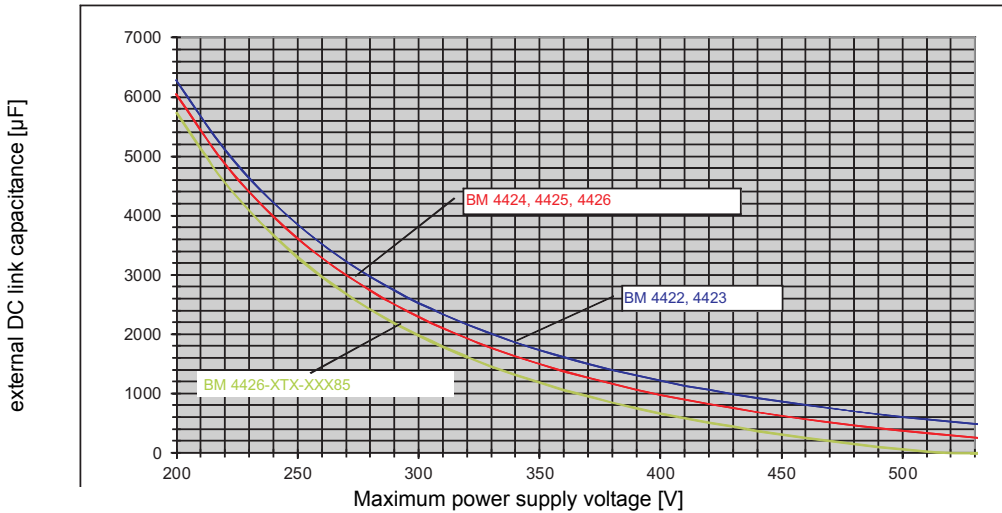

Figure 35: Maximum external DC link capacitance BM442X

- 10) The sum of the mean effective power transfer via the DC link terminals and at the motor terminals, may not exceed continuously the rated input power of the device. In addition the mean effective power transfer via the DC link terminals to further devices is limited to the specified value.
- 11) The range of the output frequency is based on a stationary operation in the linear range of the PWM, i. e. without overmodulation. The quality of the generated output voltages depends on the ratio between output frequency and current controller frequency f_{I-R} ($f_{I-R} = 1/\text{cycle time current controller}$).
The maximum output frequency f_{max} , generated with high quality, is calculated as follows:

$$f_{max} = \frac{f_{I-R}}{K_{Pf}}, \text{ typical } K_{Pf} \approx 18$$

Furthermore the controller sets an upper limit for the output frequency of 599 Hz (please contact the responsible Baumüller sales department, keyword: export restriction).

The range of the output frequency is defined as follows:

PWM frequency	Current controller cycle time	Range of the output frequency
2 kHz	250 µs	0 - 225 Hz
4 kHz/8 kHz	125 µs	0 - 450 Hz

The controller allows the device to generate output voltages with frequencies between f_{max} and 599 Hz. However the quality of this voltages cannot be guaranteed.

Typical the devices are marked with the max output frequency at 4 kHz switching frequency: 0 ... 450 kHz.

- 12) The continuously permitted output current must be reduced complying with [Output frequency dependent continuous current derating BM4XXX](#) on page 116, if the stational output frequency is lower than 15 Hz and the frequency remains between 0 and 15 Hz for over 5 seconds.

3.4 Electrical data basic units

3.4.1.3 Electrical data BM443X universal units

	BM4432	BM4433	BM4434	BM4435	
Rated input power ¹⁾²⁾	13.3 kVA	16.8 kVA	26.3 kVA	36.7 kVA	
Rated input current ¹⁾²⁾ (I_{eff})	19.2 A	24.2 A	38.0 A	53.0 A	
Total harmonic distortion input current (THD _I) ¹⁾²⁾	60 %	54 %	57 %	57 %	
Max. input current ²⁾ (I_{eff})	37.0 A	45.0 A	71.0 A	71.0 A	
Rated DC link voltage ¹⁾ (U_{DC})	540 V _{DC}				
DC link capacitance (internal)	940 μF	1230 μF	1640 μF	2000 μF	
DC link discharging time (internal DC link capacitance)	140 s	210 s	280 s	340 s	
DC link capacitance (external), permitted	Max. 20 mF				
Capacitance DC link to PE	22 nF				
Waiting period between two power up processes	None				
Output voltage ¹⁾³⁾ (U_{AC})	3 x 0 V to 3 x 370 V				
Output frequency at 4 kHz ¹⁰⁾	0 Hz to 450 Hz				
Rated output current ¹⁾⁵⁾⁶⁾⁷⁾¹³⁾ (I_{AC})	at 4 kHz ⁴⁾	22.5 A	30.0 A	45.0 A	60.0 A
Rated output current ¹⁾⁵⁾⁶⁾⁷⁾¹³⁾ (I_{AC})	at 8 kHz ⁴⁾	18.0 A	24.0 A	36.0 A	48.0 A
Output peak current ¹⁾⁵⁾⁶⁾⁸⁾¹³⁾ (I_{AC})	at 4 kHz ⁴⁾	45.0 A	60.0 A	90.0 A	90.0 A
Output peak current ¹⁾⁵⁾⁶⁾⁸⁾¹³⁾ (I_{AC})	at 8 kHz ⁴⁾	36.0 A	48.0 A	72.0 A	72.0 A
Max. peak current period ⁸⁾	60 s				
Connected load DC link terminals ⁹⁾	Max. 10.0 kW				
Brake resistor current, permitted (\hat{I})	Max. 36.0 A		Max. 50.0 A		
Brake resistor external	≥ 22 Ω		≥ 16 Ω		
Brake resistor threshold (\hat{U})	780 V				
Brake resistor peak power	29 kW		40 kW		
Permitted continuous power brake resistor external	10 kW				
Power loss referring to power input	300 W	390 W	600 W	840 W	
Power input referring to control voltage	Max. 88 W				
Current of the integrated brake control	Max. 4.0 A Max. 8.0 A ^{11) 12)}				
Cooling air requirement power heat sinks	310 m ³ /h				
Cooling air requirement internal space	39 m ³ /h				

- 1) All rated values refer to a DC link voltage of 540 V, a control voltage of 24 V and an environmental temperature of 40 °C.
- 2) Using the power choke listed in [Power chokes](#) on page 306 at a power supply with $U_{K, \text{power supply}} = 0.4 \%$.
- 3) The output voltage is a pulsed DC voltage. The operating range refers to the RMS of the fundamental wave.

$$U_{AC} = 3 \times 0 \text{ V to } 3 \times \left(\frac{U_{DC}}{\sqrt{2}} - 10 \text{ V} \right) \text{ without overmodulation of the PWM.}$$

- 4) Switching frequency of the inverter (adjustable).
- 5) RMS at an environmental temperature of 40 °C.
- 6) At rated power supply voltage the unit supplies rated / maximum output currents. With input voltages above the rated power supply voltage the output currents must be reduced at constant output power.

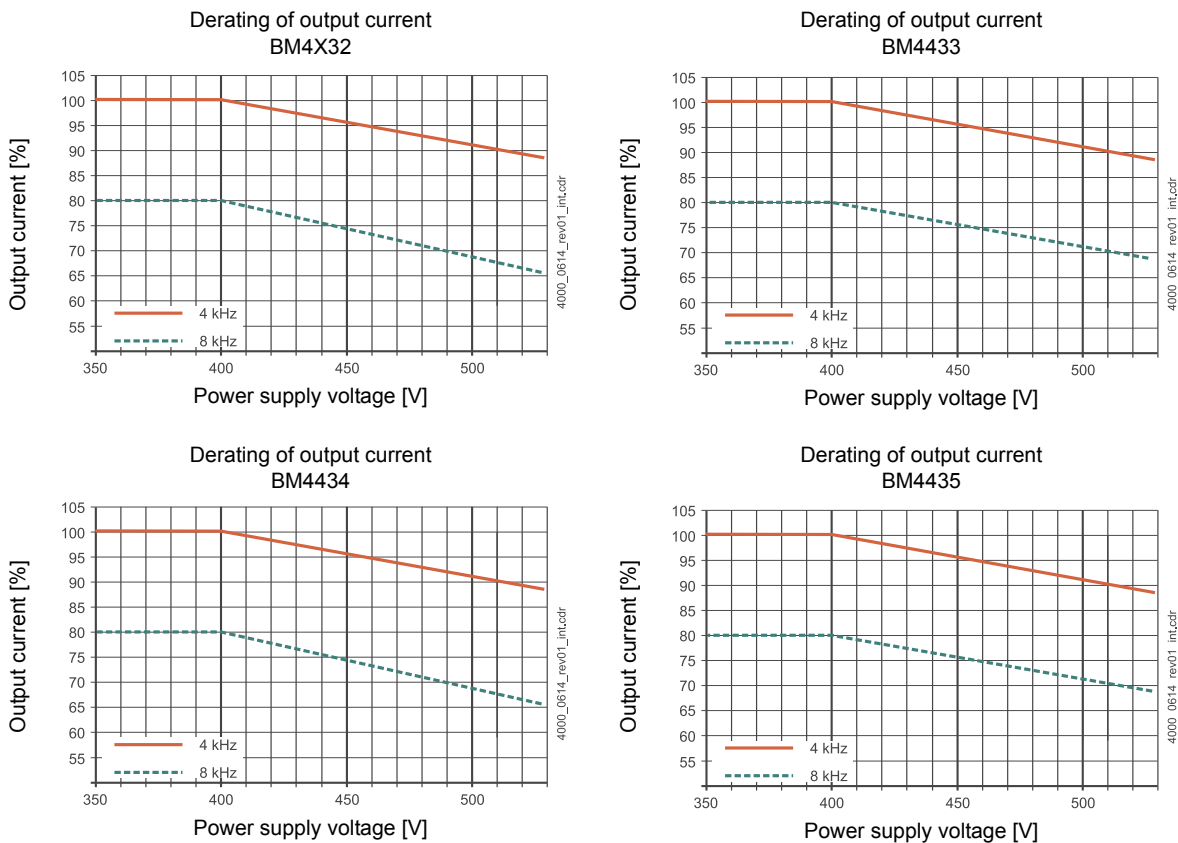

Figure 36: Derating the output current BM443X universal units

- 7) The input current must be reduced between 40 °C and 55 °C. Refer to correction factors at changed operating conditions [Environmental temperature](#) on page 59.
- 8) The peak output current is supplied for the maximum peak current period for the motor at the first acceleration (cold power unit). The in fact possible overload time is dependent on the preload of the device and on the heat sink temperature, it is determined by the overload monitoring of the device.
- 9) The sum of the mean effective power transfer via the DC link terminals and at the motor terminals, may not exceed continuously the rated input power of the device. In addition the mean effective power transfer via the DC link terminals to further devices is limited to the specified value.

3.4 Electrical data basic units

¹⁰⁾The range of the output frequency is based on a stationary operation in the linear range of the PWM, i. e. without overmodulation. The quality of the generated output voltages depends on the ratio between output frequency and current controller frequency f_{I-R} ($f_{I-R} = 1/\text{cycle time current controller}$).

The maximum output frequency f_{\max} , generated with high quality, is calculated as follows:

$$f_{\max} = \frac{f_{I-R}}{K_{pf}}, \text{ typical } K_{pf} \approx 18$$

Furthermore the controller sets an upper limit for the output frequency of 599 Hz (please contact the responsible Baumüller sales department, keyword: export restriction).

The range of the output frequency is defined as follows:

PWM frequency	Current controller cycle time	Range of the output frequency
2 kHz	250 μ s	0 - 225 Hz
4 kHz/8 kHz	125 μ s	0 - 450 Hz

The controller allows the device to generate output voltages with frequencies between f_{\max} and 599 Hz. However the quality of this voltages cannot be guaranteed.

Typical the devices are marked with the max output frequency at 4 kHz switching frequency: 0 ... 450 kHz.

¹¹⁾Refer to [►Explanation version code◄](#) on page 134 at generation 2.

¹²⁾At maximum 4 A, if UL508 C is complied with.

¹³⁾The continuously permitted output current must be reduced complying with [►Output frequency dependent continuous current derating BM4XXX◄](#) on page 116, if the statical output frequency is lower than 15 Hz and the frequency remains between 0 and 15 Hz for over 5 seconds.

3.4.1.4 Electrical data BM444X universal units

	BM4443	BM4444	BM4445	BM4446 ^{13) 16)}
Rated input power ¹⁾²⁾	48 kVA	58 kVA	73 kVA	94 kVA
Rated input current ¹⁾²⁾ (I_{eff})	70.0 A	84 A	105 A	136 A
Total harmonic distortion input current ¹⁾²⁾ (THD _i)	60 %	59 %	45 %	38 %
Max. input current ²⁾ (I_{eff})	105 A	105 A	133 A	187 A
Rated DC link voltage ¹⁾	540 V _{DC}			
DC link capacitance (internal)	1880 μF	2350 μF	3055 μF	3760 μF
DC link capacitance (external), permitted	refer to ▶Page 233◀			
DC link discharging time (internal DC link capacitance)	45 s	55 s	70 s	90 s
Capacitance DC link to PE	22 nF			
Waiting period between two power up processes	None			
Output voltage ¹⁾³⁾ (U_{AC})	3 x 0 V to 3 x 370 V			
Output frequency at 4 kHz ¹²⁾	0 Hz to 450 Hz			
Rated output current ¹⁾⁵⁾⁶⁾⁷⁾¹⁵⁾ (I_{AC}) at 4 kHz ⁴⁾	80 A	100 A	130 A	150 A
Rated output current ¹⁾⁵⁾⁶⁾⁷⁾¹⁵⁾ (I_{AC}) at 8 kHz ⁴⁾	75 A	72 A	94 A	105 A
Output peak current ¹⁾⁵⁾⁶⁾⁸⁾¹⁵⁾ (I_{AC}) at 4 kHz ⁴⁾	120 A	130 A	170 A	200 A
Output peak current ¹⁾⁵⁾⁶⁾⁸⁾¹⁵⁾ (I_{AC}) at 8 kHz ⁴⁾	90 A	94 A	130 A	150 A
Max. peak current period ^{8) 9)}	60 s			
Connected load DC link terminals ¹¹⁾	Max. 90 kW			
Brake resistor current, permitted (\hat{I})	Max. 67 A	Max. 100 A		
Brake resistor external	≥ 12 Ω	≥ 7,4 Ω ¹⁷⁾		
Brake resistor threshold (\hat{U})	780 V			
Brake resistor peak power	53 kW	80 kW		
Permitted continuous power brake resistor external	36 kW	45 kW	58 kW	75 kW
Power loss referring to the power input	1080 W	1350 W	1740 W	2000 W
Power input referring to control voltage	Max. 75 W			
Power input of fan of device referring to 230 V _{AC} ¹⁰⁾	87 W			
Current of integrated brake control	Max. 8.0 A ¹⁴⁾			
Cooling air requirement power heat sinks	260 m ³ /h		210 m ³ /h	
Cooling air requirement internal space	60 m ³ /h			
Requirements to the water cooling	Refer to ▶Page 63◀			

3.4 Electrical data basic units

- 1) All rated values refer to a DC link voltage of 540 V, a control voltage of 24 V and an environmental temperature of 40 °C.
- 2) Using the power choke listed in [Power chokes](#) on page 306 at a power supply with $U_{K, \text{power supply}} = 0.4 \%$.
- 3) The output voltage is a pulsed DC voltage. The operating range refers to the RMS of the fundamental wave.

$$U_{AC} = 3 \times 0 \text{ V to } 3 \times \left(\frac{U_{DC}}{\sqrt{2}} - 10 \text{ V} \right) \text{ without overmodulation of the PWM.}$$

- 4) Switching frequency of the inverter (adjustable).
- 5) RMS at an environmental temperature of 40 °C.
- 6) At rated power supply voltage the unit supplies rated / maximum output currents. With input voltages above the rated power supply voltage the output currents must be reduced at constant output power.

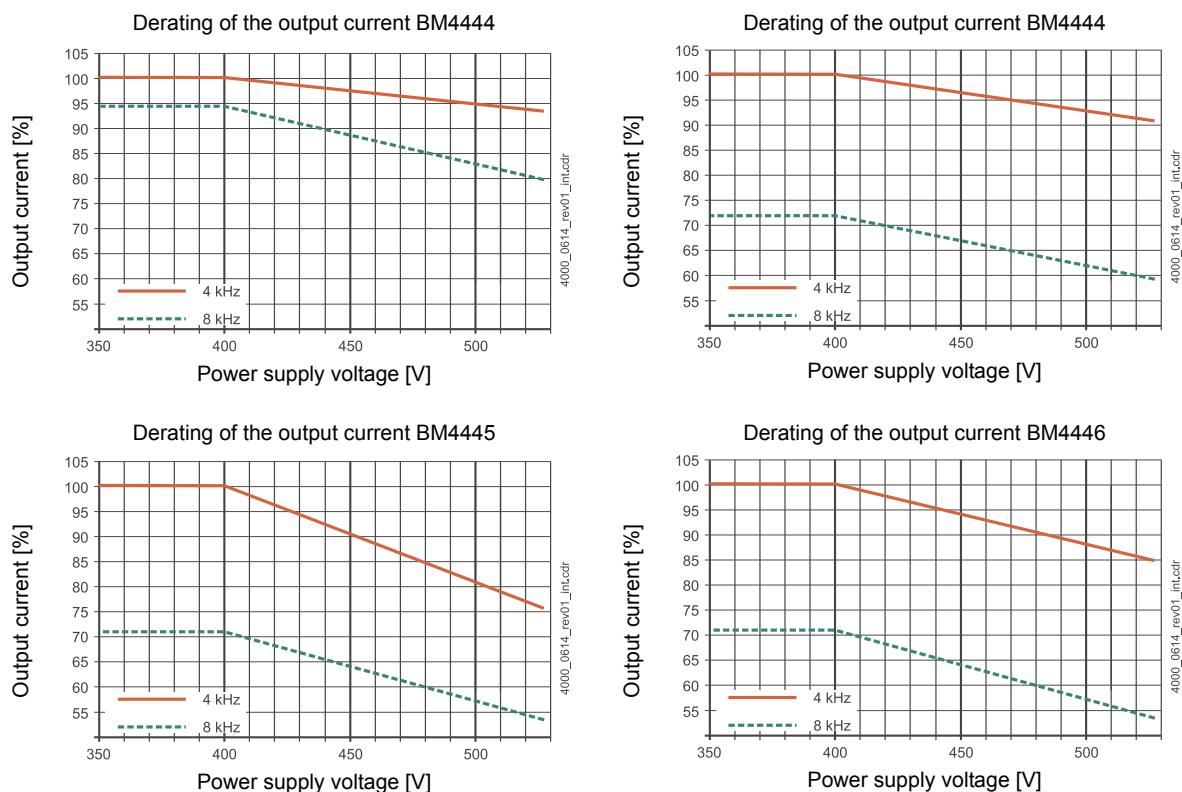

Figure 37: Derating the output current BM444X universal units

- 7) The input current must be reduced between 40 °C and 55 °C. Refer to correction factors at changed operating conditions [Environmental temperature](#) on page 59.
- 8) The peak output current is supplied for the maximum peak current period for the motor at the first acceleration (cold power unit). The in fact possible overload time is dependent on the preload of the device and on the heat sink temperature, it is determined by the overload monitoring of the device.
- 9) Peak current can be supplied at a heat sink temperature of <75 °C (BM4X43) and <80 °C (BM4X44), only. If these heat sink temperature thresholds are exceeded, the output current is automatically derated to the rated current.
- 10) For cooling versions S and A, only.
- 11) The sum of the mean effective power transfer via the DC link terminals and at the motor terminals, may not exceed continuously the rated input power of the device. In addition the mean effective power transfer via the DC link terminals to further devices is limited to the specified value.
- 12) Available at device with type code BM44XX-XX-XXXXX-03 with controller version code 4-yyy-xxx, whereat yyy > 024 **and** the controller firmware version must be 3.09 or higher. Switching off a device at a motor short circuit may damage the device.

13) The range of the output frequency is based on a stationary operation in the linear range of the PWM, i. e. without overmodulation. The quality of the generated output voltages depends on the ratio between output frequency and current controller frequency f_{I-R} ($f_{I-R} = 1/\text{cycle time current controller}$).

The maximum output frequency f_{max} , generated with high quality, is calculated as follows:

$$f_{max} = \frac{f_{I-R}}{K_{pf}}, \text{ typical } K_{pf} \approx 18$$

Furthermore the controller sets an upper limit for the output frequency of 599 Hz (please contact the responsible Baumüller sales department, keyword: export restriction).

The range of the output frequency is defined as follows:

PWM frequency	Current controller cycle time	Range of the output frequency
2 kHz	250 μ s	0 - 225 Hz
4 kHz/8 kHz	125 μ s	0 - 450 Hz

The controller allows the device to generate output voltages with frequencies between f_{max} and 599 Hz. However the quality of this voltages cannot be guaranteed.

Typical the devices are marked with the max output frequency at 4 kHz switching frequency: 0 ... 450 kHz.

14) At a hardware status of < 4006 or if UL508C is complied with: at maximum 4 A

15) The continuously permitted output current must be reduced complying with [▶Output frequency dependent continuous current derating BM4XXX◀](#) on page 116, if the statical output frequency is lower than 15 Hz and the frequency remains between 0 and 15 Hz for over 5 seconds.

16) The motor connection of the device provides a limited short-circuit protection.

17) The life time of the brake transistor depends on a large extent on the load cycle, a load cycle (braking period) of shorter than 18 s reduces the brake transistor's life time to below 20 000 hours.

3.4 Electrical data basic units

3.4.1.5 Electrical data BM445X universal units

	BM4452	BM4453	BM4454	
Rated input power ¹⁾²⁾	75.5 kVA	94.2 kVA	138.6 kVA	
Rated input current ¹⁾²⁾ (I_{eff})	109 A	136 A	200 A	
Total harmonic distortion input current ¹⁾²⁾ (THD _I)	42 %	38 %	38 %	
Max. input current ²⁾ (I_{eff})	146 A	182 A	270 A	
Rated DC link voltage ¹⁾	540 V _{DC}			
DC link capacitance (internal)	3000 µF		6600 µF	
DC link capacitance (external), permitted	refer to Page 233			
DC link discharging time (internal DC link capacitance)	75 s		140 s	
Capacitance DC link to PE	44 nF			
Waiting time between two power up processes	None			
Output voltage ¹⁾³⁾ (U_{AC})	3 x 0 V to 3 x 370 V			
Output frequency at 4 kHz ¹⁾²⁾	0 Hz to 450 Hz			
Rated output current ¹⁾⁵⁾⁶⁾⁷⁾ (I_{AC})	at 4 kHz ⁴⁾	120 A ¹⁴⁾	150 A ¹⁴⁾	210 A ¹³⁾
Rated output current ¹⁾⁵⁾⁶⁾⁷⁾ (I_{AC})	at 8 kHz ⁴⁾	96 A ¹⁴⁾	116 A ¹⁴⁾	150 A ¹³⁾
Output peak current ¹⁾⁵⁾⁶⁾⁸⁾ (I_{AC})	at 4 kHz ⁴⁾	180 A ¹⁴⁾	195 A ¹⁴⁾	260 A ¹³⁾
Output peak current ¹⁾⁵⁾⁶⁾⁸⁾ (I_{AC})	at 8 kHz ⁴⁾	144 A ¹⁴⁾	150 A ¹⁴⁾	185 A ¹³⁾
Max. peak current period ⁸⁾	60 s			
Connected load DC link terminals ¹⁵⁾	Max. 110 kW			
Brake resistor current, permitted (\hat{I})	Max. 150 A			
Brake resistor external	≥ 5 Ω			
Brake resistor threshold (\hat{U}) ¹¹⁾	780 V			
Brake resistor peak power	117 kW			
Permitted continuous power brake resistor external	78 kW			
Power loss referring to power input	1800 W	2250 W	3300 W	
Power input referring to control voltage	Max. 75 W			
Power input of the device fan referring to 230 V _{AC} ⁹⁾	190 W			
Current of integrated brake control	Max. 8.0 A ¹⁰⁾			
Cooling air requirement referring to power heat sinks	450 m ³ /h			
Cooling air requirement device internal space	135 m ³ /h			

- 1) All rated values refer to a DC link voltage of 540 V, a control voltage of 24 V and an environmental temperature of 40 °C.
- 2) Using the power choke listed in [Power chokes](#) on page 306 at a power supply with $U_{K, \text{power supply}} = 0.4 \%$.
- 3) The output voltage is a pulsed DC voltage. The operating range refers to the RMS of the fundamental wave.

$$U_{AC} = 3 \times 0 \text{ V to } 3 \times \left(\frac{U_{DC}}{\sqrt{2}} - 10 \text{ V} \right) \text{ without overmodulation of the PWM.}$$

- 4) Switching frequency of the inverter (adjustable).
- 5) RMS at an environmental temperature of 40 °C.
- 6) At rated power supply voltage the unit supplies rated / maximum output currents. With input voltages above the rated power supply voltage the output currents must be reduced at constant output power.

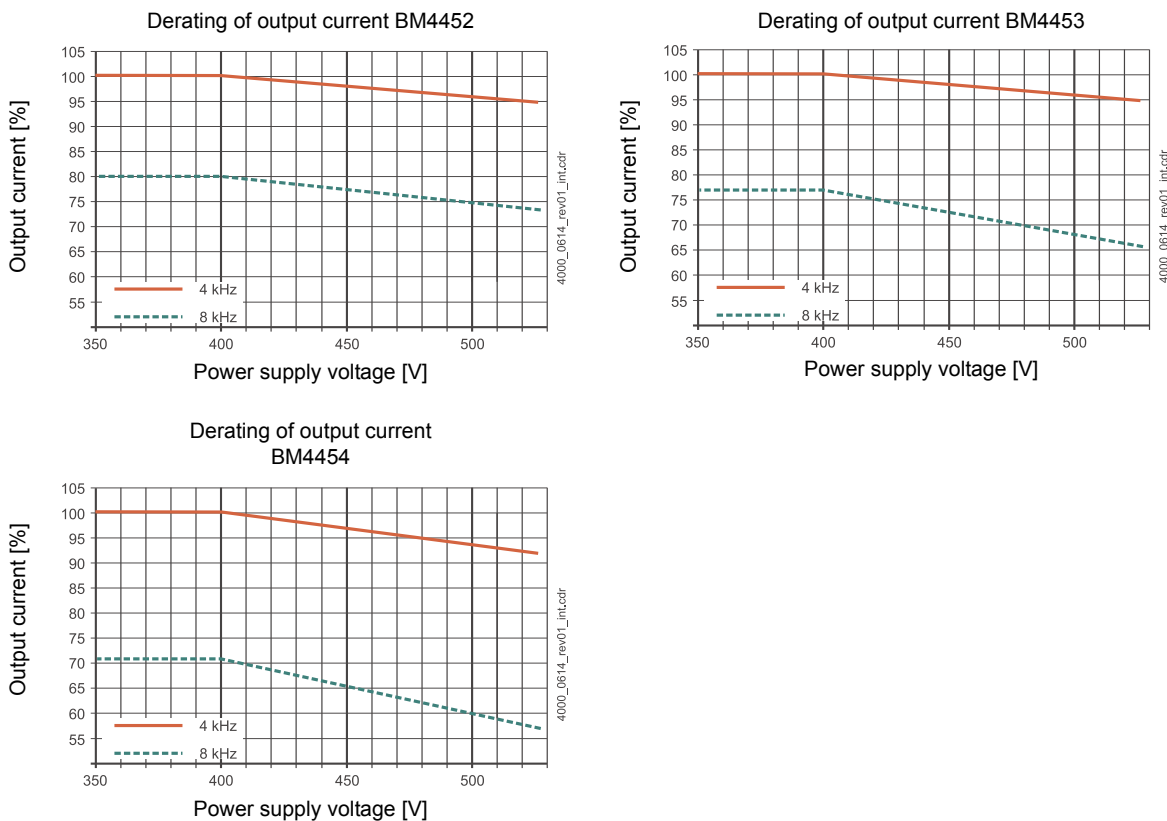

Figure 38: Reducing of output current BM445X universal units

- 7) The input current must be reduced between 40 °C and 55 °C. Refer to correction factors at changed operating conditions [Environmental temperature](#) on page 59.
- 8) The peak output current is supplied for the maximum peak current period for the motor at the first acceleration (cold power unit). The in fact possible overload time is dependent on the preload of the device and on the heat sink temperature, it is determined by the overload monitoring of the device.
- 9) For cooling versions S and A.
- 10) UL508C is complied with: max. 4.0 A.
- 11) Refer to [Motor requirements](#) on page 56.

3.4 Electrical data basic units

12) The range of the output frequency is based on a stationary operation in the linear range of the PWM, i. e. without overmodulation. The quality of the generated output voltages depends on the ratio between output frequency and current controller frequency f_{I-R} ($f_{I-R} = 1/\text{cycle time current controller}$).

The maximum output frequency f_{\max} , generated with high quality, is calculated as follows:

$$f_{\max} = \frac{f_{I-R}}{K_{pf}}, \text{ typical } K_{pf} \approx 18$$

Furthermore the controller sets an upper limit for the output frequency of 599 Hz (please contact the responsible Baumüller sales department, keyword: export restriction).

The range of the output frequency is defined as follows:

PWM frequency	Current controller cycle time	Range of the output frequency
2 kHz	250 μ s	0 - 225 Hz
4 kHz/8 kHz	125 μ s	0 - 450 Hz

The controller allows the device to generate output voltages with frequencies between f_{\max} and 599 Hz. However the quality of this voltages cannot be guaranteed.

Typical the devices are marked with the max output frequency at 4 kHz switching frequency: 0 ... 450 kHz.

13) With an output frequency lower than 0.5 Hz, the output current may be 80 % at maximum of the rated output current.

14) The continuously permitted output current must be reduced complying with [►Output frequency dependent continuous current derating BM4XXX◄](#) on page 116, if the statical output frequency is lower than 15 Hz and the frequency remains between 0 and 15 Hz for over 5 seconds.

15) The sum of the mean effective power transfer via the DC link terminals and at the motor terminals, may not exceed continuously the rated input power of the device. In addition the mean effective power transfer via the DC link terminals to further devices is limited to the specified value.

3.4.1.6 Electrical data BM446X universal units

	BM4462	BM4463	BM4466 ^{14) 16)}
Rated input power ¹⁾²⁾	164 kVA	204 kVA	238 kVA
Rated input current ¹⁾²⁾ (I _{eff})	237 A	295 A	344 A
Total harmonic distortion input current ¹⁾²⁾ (THD _I)	43 %	50 %	50 %
Max. input current ²⁾ (I _{eff})	320 A	395 A	455 A
Rated DC link voltage ¹⁾	540 V _{DC}		
DC link capacitance (internal)	6000 µF		13200 µF
DC link capacitance (external), permitted	Refer to Page 233		
DC link discharging time (internal DC link capacitance)	150 s		280 s
Capacitance DC link to PE	44 nF		
Waiting period between two power up processes	None		
Output voltage ¹⁾³⁾ (U _{AC})	3 x 0 V to 3 x 370 V		
Output frequency at 4 kHz ¹²⁾	0 Hz to 450 Hz		
Rated output current ¹⁾⁵⁾⁶⁾⁷⁾¹⁵⁾ (I _{AC})	at 4 kHz ⁴⁾	250 A	300 A
Rated output current ¹⁾⁵⁾⁶⁾⁷⁾¹⁵⁾ (I _{AC})	at 8 kHz ⁴⁾	200 A	240 A
Output peak current ¹⁾⁵⁾⁶⁾⁸⁾¹⁵⁾ (I _{AC})	at 4 kHz ⁴⁾	325 A	390 A
Output peak current ¹⁾⁵⁾⁶⁾⁸⁾¹⁵⁾ (I _{AC})	at 8 kHz ⁴⁾	260 A	312 A
Max. peak current period ⁸⁾	60 s		
Connected load DC link terminals ¹⁷⁾	Max. 160 kW		
Brake resistor current, permitted (Î)	Max. 230 A		Max. 236 A
Brake resistor external	≥ 3.4 Ω		≥ 3.33 Ω
Brake resistor threshold (Û) ¹¹⁾	780 V		
Brake resistor peak power	179 kW		183 kW
Permitted continuous power brake resistor external	130 kW		
Power loss referring to power input	3960 W	4800 W	
Power input referring to control voltage	Max. 80 W		
Power input of the device fan referring to 230 V _{AC} ⁹⁾	174 W		
Current of integrated brake control	Max. 8.0 A ¹⁰⁾		
Cooling air requirement power heat sink	450 m ³ /h		
Cooling air requirement device internal space	200 m ³ /h		

3.4 Electrical data basic units

- 1) All rated values refer to a DC link voltage of 540 V, a control voltage of 24 V and an environmental temperature of 40 °C.
- 2) Using the power choke listed in [►Power chokes◄](#) on page 306 at a power supply with $U_{K, \text{power supply}} = 0.4 \%$.
- 3) The output voltage is a pulsed DC voltage. The operating range refers to the RMS of the fundamental wave.

$$U_{AC} = 3 \times 0 \text{ V to } 3 \times \left(\frac{U_{DC}}{\sqrt{2}} - 10 \text{ V} \right) \text{ without overmodulation of the PWM.}$$

- 4) Switching frequency of the inverter (adjustable).
- 5) RMS at an environmental temperature of 40 °C.
- 6) At rated power supply voltage the unit supplies rated / maximum output currents. With input voltages above the rated power supply voltage the output currents must be reduced at constant output power.

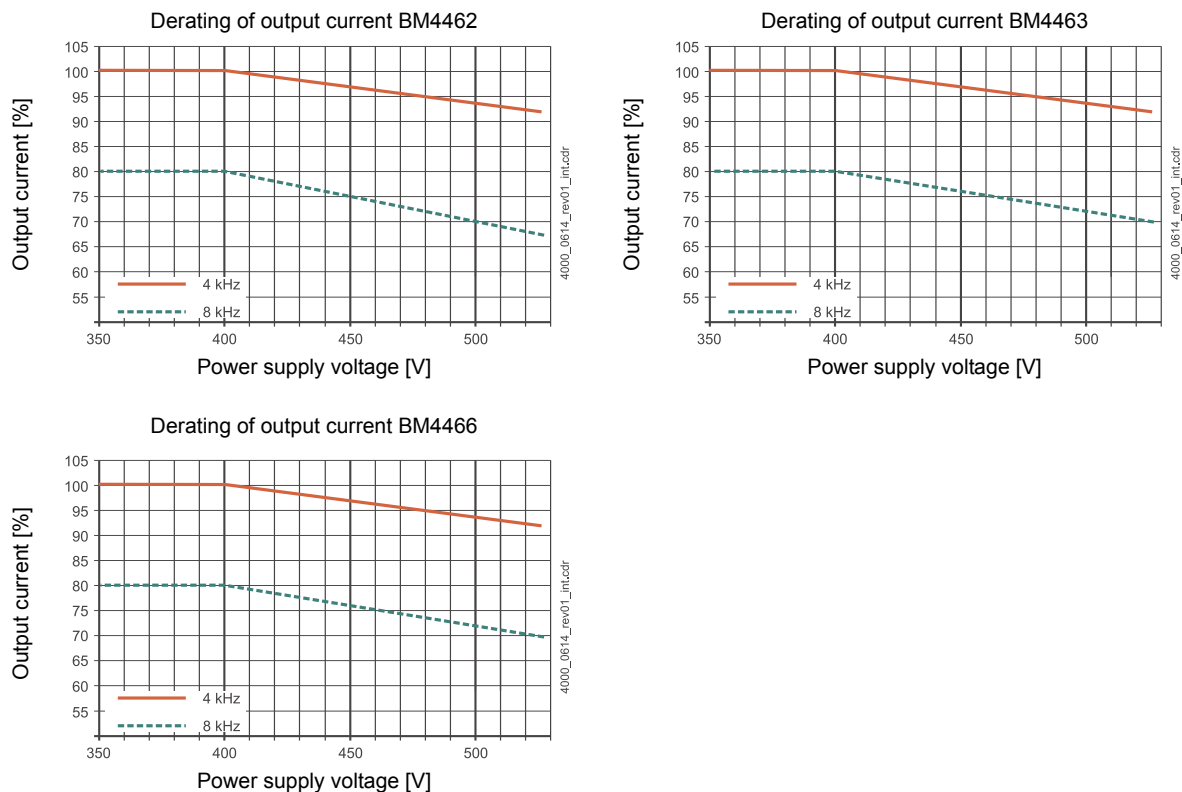

Figure 39: Reducing of output current BM 446X universal units

- 7) The input current must be reduced between 40 °C and 55 °C. Refer to correction factors at changed operating conditions [►Environmental temperature◄](#) on page 59.
- 8) The peak output current is supplied for the maximum peak current period for the motor at the first acceleration (cold power unit). The in fact possible overload time is dependent on the preload of the device and on the heat sink temperature, it is determined by the overload monitoring of the device.
- 9) For cooling versions S and A, only.
- 10) If UL508C is complied with: max. 4.0 A.
- 11) Refer to [►Motor requirements◄](#) on page 56.

12) The range of the output frequency is based on a stationary operation in the linear range of the PWM, i. e. without overmodulation. The quality of the generated output voltages depends on the ratio between output frequency and current controller frequency f_{i-R} ($f_{i-R} = 1/\text{cycle time current controller}$).

The maximum output frequency f_{max} , generated with high quality, is calculated as follows:

$$f_{max} = \frac{f_{i-R}}{K_{pf}}, \text{ typical } K_{pf} \approx 18$$

Furthermore the controller sets an upper limit for the output frequency of 599 Hz (please contact the responsible Baumüller sales department, keyword: export restriction).

The range of the output frequency is defined as follows:

PWM frequency	Current controller cycle time	Range of the output frequency
2 kHz	250 μ s	0 - 225 Hz
4 kHz/8 kHz	125 μ s	0 - 450 Hz

The controller allows the device to generate output voltages with frequencies between f_{max} and 599 Hz. However the quality of this voltages cannot be guaranteed.

Typical the devices are marked with the max output frequency at 4 kHz switching frequency: 0 ... 450 kHz.

13) Using internal brake resistors, the continuous brake resistor power is 5 kW.

14) The controller firmware version must be 3.10 or higher.

15) The continuously permitted output current must be reduced complying with [►Output frequency dependent continuous current derating BM4XXX◄](#) on page 116, if the statical output frequency is lower than 15 Hz and the frequency remains between 0 and 15 Hz for over 5 seconds.

16) The motor connection of the device provides a limited short-circuit protection.

17) The sum of the mean effective power transfer via the DC link terminals and at the motor terminals, may not exceed continuously the rated input power of the device. In addition the mean effective power transfer via the DC link terminals to further devices is limited to the specified value.

3.4 Electrical data basic units

3.4.1.7 Electrical data BM4X7X universal units

	BM4472 - A/F	BM4473 - A/F	
Rated input power ¹⁾²⁾	328 kVA	412 kVA	
Rated input current ¹⁾²⁾ (I_{eff})	474 A	594 A	
Total harmonic distortion input current ¹⁾²⁾ (THD _I)	54 %		
Max. input current ²⁾ (I_{eff})	602 A	760 A	
DC link rated voltage ¹⁾	540 V _{DC}		
DC link capacitance (internal)	19.8 mF		
DC link capacitance (external), permitted	Refer to Page 233		
DC link discharging time (internal DC link capacitance)	150 s		
Capacitance DC link to PE	240 nF		
Waiting time between two power up processes	None		
Output voltage ¹⁾³⁾ (U_{AC})	3 x 0 V bis 3 x 370 V		
Output frequency at 4 kHz ¹⁴⁾	0 Hz bis 450 Hz		
Rated output current ¹⁾⁵⁾⁶⁾⁷⁾¹³⁾¹⁵⁾ (I_{AC})	at 4 kHz ⁴⁾	450 A	615 A
Rated output current ¹⁾⁵⁾⁶⁾⁷⁾¹³⁾¹⁵⁾ (I_{AC})	at 8 kHz ⁴⁾	338 A	420 A
Output peak current ¹⁾⁵⁾⁶⁾⁸⁾¹⁵⁾ (I_{AC})	at 4 kHz ⁴⁾	585 A	800 A
Output peak current ¹⁾⁵⁾⁶⁾⁸⁾¹⁵⁾ (I_{AC})	at 8 kHz ⁴⁾	439 A	545 A
Max. peak current period ⁹⁾	60 s		
Connected load DC link terminals ¹⁶⁾	Max. 250 kW	Max. 315 kW	
Brake resistor current, permitted (\hat{I})	Max. 300 A		
Brake resistor external	≥ 2.6 Ω		
Brake resistor threshold (\hat{U}) ¹²⁾	780 V		
Brake resistor peak power	234 kW		
Permitted continuous power brake resistor external	180 kW		
Power loss referring to power input	4700 W	6450 W	
Power input referring to control voltage	Max. 170 W		
Power input of the device fan referring to 400 V _{AC}	Max. 540 W		
Current of integrated brake control	Max. 8.0 A ¹¹⁾		
Cooling air requirement power heat sink	1000 m ³ /h		
Cooling air requirement device internal space	250 m ³ /h		

- 1) All rated values refer to a DC link voltage of 540 V, a control voltage of 24 V and an environmental temperature of 40 °C.
- 2) Using the power choke listed in [Power chokes](#) on page 306 at a power supply with $U_{K, \text{power supply}} = 0.4 \%$.
- 3) The output voltage is a pulsed DC voltage. The operating range refers to the RMS of the fundamental wave.

$$U_{AC} = 3 \times 0 \text{ V to } 3 \times \left(\frac{U_{DC}}{\sqrt{2}} - 10 \text{ V} \right) \text{ without overmodulation of the PWM.}$$

- 4) Switching frequency of the inverter (adjustable).
- 5) RMS at an environmental temperature of 40 °C.
- 6) At rated power supply voltage the unit supplies rated / maximum output currents. With input voltages above the rated power supply voltage the output currents must be reduced at constant output power

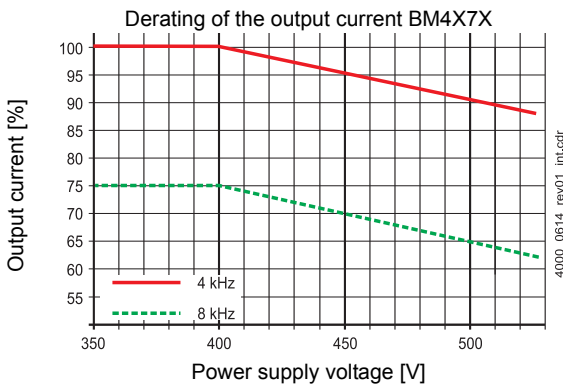

Figure 40: Derating the output current BM 447X universal units

- 7) The input current must be reduced between 40 °C and 55 °C. Refer to correction factors at changed operating conditions [Environmental temperature](#) on page 59
- 8) Two temperature values may occur (cooling air, which flows through the internal space of the device / cooling air, which flows through the heat sink). Enter the higher value.
Example: Rated output current = 150 A environmental temperature = 46 °C

$$I_o = 150 \text{ A} \cdot \left(1 - \left(\frac{46^\circ\text{C} - 40^\circ\text{C}}{^\circ\text{C}} \cdot 0,03 \right) \right) = 150 \text{ A} \cdot 0,82$$

The output current must be reduced to: 123 A

- 9) The peak output current is supplied for the maximum peak current period for the motor at the first acceleration (cold power unit). The in fact possible overload time is dependent on the preload of the device and on the heat sink temperature, it is determined by the overload monitoring of the device.
- 10) The sum of the mean effective power transfer via the DC link terminals and at the motor terminals, may not exceed continuously the rated input power of the device. In addition the mean effective power transfer via the DC link terminals to further devices is limited to the specified value.
- 11) If UL508C is complied with: max. 4.0 A.
- 12) Refer to [Motor requirements](#) on page 56.
- 13) If UL508C is complied with:
The permitted typical motor output is limited to 295 kW at a maximum. The device BM4473 belongs to the category < 400 HP, < 298 kW ratings complying with table 45.1 of UL508C. Therefore, the short-circuit test using 18k A can be executed. Baumüller does not offer devices in the class 600 HP, 447 kW with 30 kA short-circuit current in accordance with UL508C.

3.4 Electrical data basic units

- 14) The range of the output frequency is based on a stationary operation in the linear range of the PWM, i. e. without overmodulation. The quality of the generated output voltages depends on the ratio between output frequency and current controller frequency f_{I-R} ($f_{I-R} = 1/\text{cycle time current controller}$). The maximum output frequency f_{\max} , generated with high quality, is calculated as follows:

$$f_{\max} = \frac{f_{I-R}}{K_{pf}}, \text{ typical } K_{pf} \approx 18$$

Furthermore the controller sets an upper limit for the output frequency of 599 Hz (please contact the responsible Baumüller sales department, keyword: export restriction).

The range of the output frequency is defined as follows:

PWM frequency	Current controller cycle time	Range of the output frequency
2 kHz	250 μs	0 - 225 Hz
4 kHz/8 kHz	125 μs	0 - 450 Hz

The controller allows the device to generate output voltages with frequencies between f_{\max} and 599 Hz. However the quality of this voltages cannot be guaranteed.

Typical the devices are marked with the max output frequency at 4 kHz switching frequency: 0 ... 450 kHz.

- 15) The continuously permitted output current must be reduced complying with [►Output frequency dependent continuous current derating BM4XXX◄](#) on page 116, if the static output frequency is lower than 15 Hz and the frequency remains between 0 and 15 Hz for over 5 seconds.
- 16) The sum of the mean effective power transfer via the DC link terminals and at the motor terminals, may not exceed continuously the rated input power of the device. In addition the mean effective power transfer via the DC link terminals to further devices is limited to the specified value.

3.4.2 Electrical data BM46XX acceleration units

Acceleration units are developed for a cycle with 1.25 s peak current at a total cycle of 5 s, refer to [►Figure 30◄](#) on page 61. The units are not developed for using at standstill or output frequencies lower than 10 Hz with peak current. For this units the [►Output frequency dependent continuous current derating BM4XXX◄](#) on page 116 and the [►Output frequency dependent maximum current derating BM46XX◄](#) on page 117.



NOTE!

The acceleration units require a controller FW version 3.10 or higher!

3.4.2.1 Electrical data BM4632 acceleration units

		BM4632
Rated input power ¹⁾²⁾		36,7 kVA
Rated input current ¹⁾²⁾ (I_{eff})		53,0 A
Distortion factor of the input current ¹⁾²⁾ (THD _I)		57 %
Max. input current ²⁾ (I_{eff})		128 A
DC link rated voltage ¹⁾		540 V _{DC}
DC link capacitance (internal)		3000 µF
DC link capacitance (external), permitted		Refer to ▶Page 233◀
DC link discharging time (internal DC link capacitance)		140 s
Capacitance DC link to PE		22 nF
Waiting time between two power up processes		None
Output voltage ¹⁾³⁾ (U_{AC})		3 x 0 V to 3 x 370 V
Output frequency at 4 kHz ¹⁰⁾		0 Hz to 450 Hz
Rated output current ¹⁾⁵⁾⁶⁾⁷⁾¹²⁾ (I_{AC})	at 4 kHz ⁴⁾	60 A
Rated output current ¹⁾⁵⁾⁶⁾⁷⁾¹²⁾ (I_{AC})	at 8 kHz ⁴⁾	48 A
Output peak current ¹⁾⁵⁾⁶⁾⁸⁾¹²⁾ (I_{AC})	at 4 kHz ⁴⁾	120 A
Output peak current ¹⁾⁵⁾⁶⁾⁸⁾¹²⁾ (I_{AC})	at 8 kHz ⁴⁾	96 A
Max. peak current period ⁸⁾		1,25 s
Connected load DC link terminals ⁹⁾		Max. 10,0 kW
Brake resistor current, permitted (\hat{I})		Max. 70,0 A
Brake resistor external		≥ 11 Ω
Brake resistor threshold (\hat{U})		780 V
Brake resistor peak power		56 kW
Permitted continuous power brake resistor external		10 kW
Power loss referring to power input		840 W
Power input referring to control voltage		Max. 88 W
Current of integrated brake control		Max. 8 A ¹¹⁾
Cooling air requirement device internal space		60 m ³ /h
Requirements to water cooling		Refer to ▶Page 63◀

3.4 Electrical data basic units

- 1) All rated values refer to a DC link voltage of 540 V, a control voltage of 24 V and an environmental temperature of 40 °C.
- 2) Using the power choke listed in [Power chokes](#) on page 306 at a power supply with $U_{K, \text{power supply}} = 0.4 \%$.
- 3) The output voltage is a pulsed DC voltage. The operating range refers to the RMS of the fundamental wave.

$$U_{AC} = 3 \times 0 \text{ V to } 3 \times \left(\frac{U_{DC}}{\sqrt{2}} - 10 \text{ V} \right) \text{ without overmodulation of the PWM.}$$

- 4) Switching frequency of the inverter (adjustable).
- 5) RMS at an environmental temperature of 40 °C.
- 6) At rated power supply voltage the unit supplies rated / maximum output currents. With input voltages above the rated power supply voltage the output currents must be reduced at constant output power.

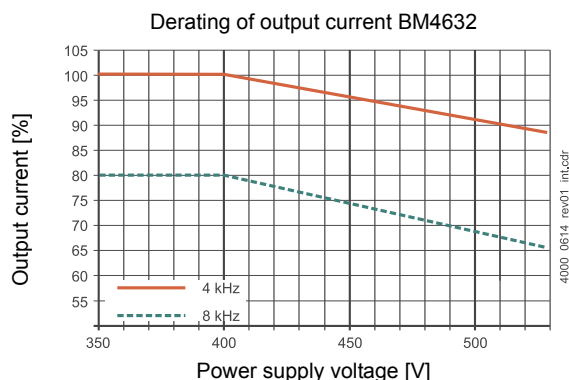

Figure 41: Derating the output current BM4632 acceleration units

- 7) The input current must be reduced between 40 °C and 55 °C. Refer to correction factors at changed operating conditions [Environmental temperature](#) on page 59.
- 8) The peak output current is supplied for the maximum peak current period for the motor at the first acceleration (cold power unit). The in fact possible overload time is dependent on the preload of the device and on the heat sink temperature, it is determined by the overload monitoring of the device.
- 9) The sum of the mean effective power transfer via the DC link terminals and at the motor terminals, may not exceed continuously the rated input power of the device. In addition the mean effective power transfer via the DC link terminals to further devices is limited to the specified value.
- 10) The range of the output frequency is based on a stationary operation in the linear range of the PWM, i. e. without overmodulation. The quality of the generated output voltages depends on the ratio between output frequency and current controller frequency f_{I-R} ($f_{I-R} = 1/\text{cycle time current controller}$).
The maximum output frequency f_{max} , generated with high quality, is calculated as follows:

$$f_{max} = \frac{f_{I-R}}{K_{pf}}, \text{ typical } K_{pf} \approx 18$$

Furthermore the controller sets an upper limit for the output frequency of 599 Hz (please contact the responsible Baumüller sales department, keyword: export restriction).

The range of the output frequency is defined as follows:

PWM frequency	Current controller cycle time	Range of the output frequency
2 kHz	250 μ s	0 - 225 Hz
4 kHz/8 kHz	125 μ s	0 - 450 Hz

The controller allows the device to generate output voltages with frequencies between f_{max} and 599 Hz. However the quality of this voltages cannot be guaranteed.

Typical the devices are marked with the max output frequency at 4 kHz switching frequency: 0 ... 450 kHz.

- 11) At maximum 4 A, if UL508 C is complied with.
- 12) The continuously permitted output current must be reduced complying with [Output frequency dependent maximum current derating BM46XX](#) on page 117, if the static output frequency is lower than 15 Hz and the frequency remains between 0 and 15 Hz for over 5 seconds.

3.4.2.2 Electrical data BM464X acceleration units

	BM4641	BM4642
Rated input power ¹⁾²⁾	57 kVA	65 kVA
Rated input current ¹⁾²⁾ (I _{eff})	82 A	95 A
Distortion factor of the input current ¹⁾²⁾ (THD _I)	50 %	50 %
Max. input current ²⁾ (I _{eff})	164 A	190 A
DC link rated voltage ¹⁾	540 V _{DC}	
DC link capacitance (internal)	3055 μF	
DC link capacitance (external), permitted	Refer to ▶Page 233◀	
DC link discharging time (internal DC link capacitance)	70 s	
Capacitance DC link to PE	22 nF	
Waiting time between two power up processes	None	
Output voltage ¹⁾³⁾ (U _{AC})	3 x 0 V to 3 x 370 V	
Output frequency at 4 kHz ¹⁾¹⁾	0 Hz to 450 Hz	
Rated output current ¹⁾⁵⁾⁶⁾⁷⁾¹²⁾ (I _{AC})	at 4 kHz ⁴⁾	85 A
Rated output current ¹⁾⁵⁾⁶⁾⁷⁾¹²⁾ (I _{AC})	at 8 kHz ⁴⁾	64 A
Output peak current ¹⁾⁵⁾⁶⁾⁸⁾¹²⁾ (I _{AC})	at 4 kHz ⁴⁾	170 A
Output peak current ¹⁾⁵⁾⁶⁾⁸⁾¹²⁾ (I _{AC})	at 8 kHz ⁴⁾	128 A
Max. peak current period ⁸⁾	1.25 s	
Connected load DC link terminals ¹⁰⁾	Max. 60 kW / 120 kW (1 s)	
Brake resistor current, permitted (Î)	Max. 100 A	
Brake resistor external	≥ 7,4 Ω ¹⁴⁾	
Brake resistor threshold (Û)	780 V	
Brake resistor peak power	80 kW	
Permitted continuous power brake resistor external	58 kW	
Power loss referring to power input	1350 W	
Power input referring to control voltage	Max. 75 W	
Power input of the fan of the device referring to 230 V _{AC} ⁹⁾	87 W	
Current of integrated brake control	Max. 8.0 A ¹⁴⁾	
Cooling air requirement device internal space	60 m ³ /h	
Requirements to water cooling	Refer to ▶Page 63◀	

¹⁾ All rated values refer to a DC link voltage of 540 V, a control voltage of 24 V and an environmental temperature of 40 °C.

²⁾ Using the power choke listed in [▶Power chokes◀](#) on page 306 at a power supply with U_{K,power supply} = 0.4 %.

³⁾ The output voltage is a pulsed DC voltage. The operating range refers to the RMS of the fundamental wave.

$$U_{AC} = 3 \times 0 \text{ V to } 3 \times \left(\frac{U_{DC}}{\sqrt{2}} - 10 \text{ V} \right) \text{ without overmodulation of the PWM.}$$

3.4 Electrical data basic units

- 4) Switching frequency of the inverter (adjustable).
- 5) RMS at an environmental temperature of 40 °C.
- 6) At rated power supply voltage the unit supplies rated / maximum output currents. With input voltages above the rated power supply voltage the output currents must be reduced at constant output power.

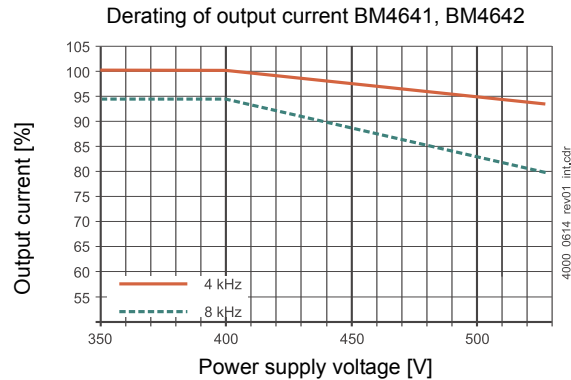

Figure 42: Derating the output current BM464X acceleration units

- 7) The input current must be reduced between 40 °C and 55 °C. Refer to correction factors at changed operating conditions [►Environmental temperature◄](#) on page 59.
- 8) The peak output current is supplied for the maximum peak current period for the motor at the first acceleration (cold power unit). The in fact possible overload time is dependent on the preload of the device and on the heat sink temperature, it is determined by the overload monitoring of the device.
- 9) For cooling versions S and A, only.
- 10) The sum of the mean effective power transfer via the DC link terminals and at the motor terminals, may not exceed continuously the rated input power of the device. In addition the mean effective power transfer via the DC link terminals to further devices is limited to the specified value.
- 11) The range of the output frequency is based on a stationary operation in the linear range of the PWM, i. e. without overmodulation. The quality of the generated output voltages depends on the ratio between output frequency and current controller frequency f_{I-R} ($f_{I-R} = 1/\text{cycle time current controller}$). The maximum output frequency f_{max} , generated with high quality, is calculated as follows:

$$f_{max} = \frac{f_{I-R}}{K_{pf}}, \text{ typical } K_{pf} \approx 18$$

Furthermore the controller sets an upper limit for the output frequency of 599 Hz (please contact the responsible Baumüller sales department, keyword: export restriction).

The range of the output frequency is defined as follows:

PWM frequency	Current controller cycle time	Range of the output frequency
2 kHz	250 μ s	0 - 225 Hz
4 kHz/8 kHz	125 μ s	0 - 450 Hz

The controller allows the device to generate output voltages with frequencies between f_{max} and 599 Hz. However the quality of this voltages cannot be guaranteed.

Typical the devices are marked with the max output frequency at 4 kHz switching frequency: 0 ... 450 kHz.

- 12) The continuously permitted output current must be reduced complying with [►Output frequency dependent maximum current derating BM46XX◄](#) on page 117, if the statical output frequency is lower than 15 Hz and the frequency remains between 0 and 15 Hz for over 5 seconds.
- 13) At maximum 4 A, if UL508 C is complied with.
- 14) The life time of the brake transistor depends on a large extent on the load cycle, a load cycle (braking period) of shorter than 18 s reduces the brake transistor's life time to below 20 000 hours.

3.4.2.3 Electrical data BM465X acceleration units

	BM4650 ¹⁴⁾	BM4651 ¹⁴⁾	BM4652 ¹⁴⁾	
Rated input power ¹⁾²⁾	86 kVA	110 kVA	139 kVA	
Rated input current ¹⁾²⁾ (I_{eff})	125 A	160 A	190 A	
Total harmonic distortion input current ¹⁾²⁾ (THD _I)	40 %			
Max. input current ²⁾ (I_{eff})	250 A	320 A	380 A	
Rated DC link voltage ¹⁾	540 V _{DC}			
DC link capacitance (internal)	6600 μF			
DC link capacitance (external), permitted	Refer to ▶Page 233			
DC link discharging time (internal DC link capacitance)	140 s			
Capacitance DC link to PE	44 nF			
Waiting time between two power up processes	None			
Output voltage ¹⁾³⁾ (U_{AC})	3 x 0 V to 3 x 370 V			
Output frequency at 4 kHz ¹²⁾	0 Hz to 450 Hz			
Rated output current ¹⁾⁵⁾⁶⁾⁷⁾¹³⁾ (I_{AC})	at 4 kHz ⁴⁾	130 A	165 A	200 A
Rated output current ¹⁾⁵⁾⁶⁾⁷⁾¹³⁾ (I_{AC})	at 8 kHz ⁴⁾	97 A	123 A	150 A
Output peak current ¹⁾⁵⁾⁶⁾⁸⁾¹³⁾ (I_{AC})	at 4 kHz ⁴⁾	260 A	330 A	400 A
Output peak current ¹⁾⁵⁾⁶⁾⁸⁾¹³⁾ (I_{AC})	at 8 kHz ⁴⁾	194 A	264 A	300 A
Max. peak current period ⁸⁾	1.25 s			
Connected load DC link terminals ¹⁵⁾	Max. 110 kW			
Brake resistor current, permitted (\hat{I})	Max. 150 A			
Brake resistor external	≥ 5 Ω			
Brake resistor threshold (\hat{U}) ¹¹⁾	780 V			
Brake resistor peak power	120 kW			
Permitted continuous power brake resistor external	80 kW			
Power loss referring to power input	2100 W	2300 W	3000 W	
Power input referring to control voltage	Max. 75 W			
Power input of device fan referring to 230 V _{AC} ⁹⁾	190 W			
Current of integrated brake control	Max. 8.0 A ¹⁰⁾			
Cooling air requirement device internal space	135 m ³ /h			
Requirement to the water cooling	Refer to ▶Page 63			

¹⁾ All rated values refer to a DC link voltage of 540 V, a control voltage of 24 V and an environmental temperature of 40 °C.

²⁾ Using the power choke listed in [▶Power chokes](#) on page 306 at a power supply with $U_{K,power\ supply} = 0.4\ %$.

3.4 Electrical data basic units

- 3) The output voltage is a pulsed DC voltage. The operating range refers to the RMS of the fundamental wave.

$$U_{AC} = 3 \times 0 \text{ V to } 3 \times \left(\frac{U_{DC}}{\sqrt{2}} - 10 \text{ V} \right) \text{ without overmodulation of the PWM.}$$

- 4) Switching frequency of the inverter (adjustable).
 5) RMS at an environmental temperature of 40 °C.
 6) At rated power supply voltage the unit supplies rated / maximum output currents. With input voltages above the rated power supply voltage the output currents must be reduced at constant output power.

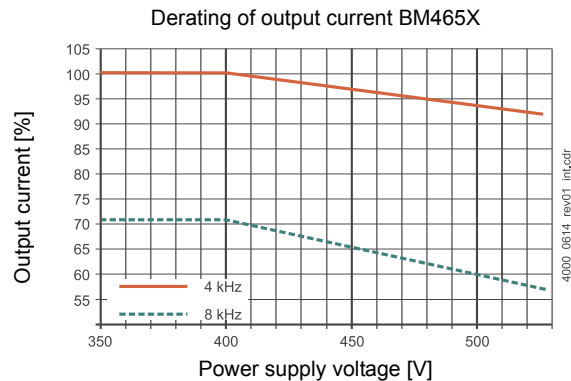

Figure 43: Derating the output current BM465X acceleration units

- 7) The input current must be reduced between 40 °C and 55 °C. Refer to correction factors at changed operating conditions [►Environmental temperature◄](#) on page 59.
- 8) The peak output current is supplied for the maximum peak current period for the motor at the first acceleration (cold power unit). The in fact possible overload time is dependent on the preload of the device and on the heat sink temperature, it is determined by the overload monitoring of the device.
- 9) For cooling versions S and A, only.
- 10) At maximum 4 A, if UL508 C is complied with.
- 11) Refer to [►Motor requirements◄](#) on page 56.
- 12) The range of the output frequency is based on a stationary operation in the linear range of the PWM, i. e. without overmodulation. The quality of the generated output voltages depends on the ratio between output frequency and current controller frequency f_{I-R} ($f_{I-R} = 1/\text{cycle time current controller}$). The maximum output frequency f_{max} , generated with high quality, is calculated as follows:

$$f_{max} = \frac{f_{I-R}}{K_{pf}}, \text{ typical } K_{pf} \approx 18$$

Furthermore the controller sets an upper limit for the output frequency of 599 Hz (please contact the responsible Baumüller sales department, keyword: export restriction).

The range of the output frequency is defined as follows:

PWM frequency	Current controller cycle time	Range of the output frequency
2 kHz	250 μ s	0 - 225 Hz
4 kHz/8 kHz	125 μ s	0 - 450 Hz

The controller allows the device to generate output voltages with frequencies between f_{max} and 599 Hz. However the quality of this voltages cannot be guaranteed.

Typical the devices are marked with the max output frequency at 4 kHz switching frequency: 0 ... 450 kHz.

- 13) The continuously permitted output current must be reduced complying with [►Output frequency dependent maximum current derating BM46XX◄](#) on page 117, if the static output frequency is lower than 15 Hz and the frequency remains between 0 and 15 Hz for over 5 seconds.
- 14) The device is available in cooling type „Z“ and „F“ with standard size (BM46XX-XXX-0XXXX) or short size (BM46XX-XXX-3XXXX).
- 15) The sum of the mean effective power transfer via the DC link terminals and at the motor terminals, may not exceed continuously the rated input power of the device. In addition the mean effective power transfer via the DC link terminals to further devices is limited to the specified value.

3.4.2.4 Electrical data BM466X acceleration units

	BM4661 ¹⁵⁾	BM4662 ¹⁵⁾¹⁶⁾
Rated input power ¹⁾²⁾	170 kVA	200 kVA
Rated input current ¹⁾²⁾ (I _{eff})	240 A	285 A
Total harmonic distortion input current ¹⁾²⁾ (THD _I)	50%	
Max. input current ²⁾ (I _{eff})	480 A	570 A
Rated DC link voltage ¹⁾	540 V _{DC}	
DC link capacitance (internal)	13200 µF	
DC link capacitance (external), permitted	Refer to ▶Page 233◀	
DC link discharging time (internal DC link capacitance)	130 s	
Capacitance DC link to PE	44 nF	
Waiting time between two power up processes	None	
Output voltage ¹⁾³⁾ (U _{AC})	3 x 0 V to 3 x 370 V	
Output frequency at 4 kHz ¹²⁾	0 Hz to 450 Hz	
Rated output current ¹⁾⁵⁾⁶⁾⁷⁾¹⁴⁾ (I _{AC})	at 4 kHz ⁴⁾	250 A
Rated output current ¹⁾⁵⁾⁶⁾⁷⁾¹⁴⁾ (I _{AC})	at 8 kHz ⁴⁾	187 A
Output peak current ¹⁾⁵⁾⁶⁾⁸⁾¹⁴⁾ (I _{AC})	at 4 kHz ⁴⁾	500 A
Output peak current ¹⁾⁵⁾⁶⁾⁸⁾¹⁴⁾ (I _{AC})	at 8 kHz ⁴⁾	374 A
Max. peak current period ⁸⁾	1.25 s	
Connected load DC link terminals ¹⁶⁾	Max. 160 kW	
Brake resistor current, permitted (Î)	Max. 230 A	
Brake resistor external	≥ 3.4 Ω	
Brake resistor threshold (Û) ¹¹⁾	780 V	
Brake resistor peak power	179 kW	
Permitted continuous power brake resistor external	130 kW	
Power loss referring to power input	3500 W	4200 W
Power input referring to control voltage	Max. 80 W	
Power input of the device fan referring to 230 V _{AC} ⁹⁾	174 W	
Current of integrated brake control	Max. 8.0 A ¹⁰⁾	
Cooling air requirement power heat sinks	450 m ³ /h	
Cooling air requirement device internal space	200 m ³ /h	

1) All rated values refer to a DC link voltage of 540 V, a control voltage of 24 V and an environmental temperature of 40 °C.

2) Using the power choke listed in [▶Power chokes◀](#) on page 306 at a power supply with U_{K,power supply} = 0.4 %.

3) The output voltage is a pulsed DC voltage. The operating range refers to the RMS of the fundamental wave.

$$U_{AC} = 3 \times 0 \text{ V to } 3 \times \left(\frac{U_{DC}}{\sqrt{2}} - 10 \text{ V} \right) \text{ without overmodulation of the PWM.}$$

4) Switching frequency of the inverter (adjustable).

3.4 Electrical data basic units

- 5) RMS at an environmental temperature of 40 °C.
- 6) At rated power supply voltage the unit supplies rated / maximum output currents. With input voltages above the rated power supply voltage the output currents must be reduced at constant output power.

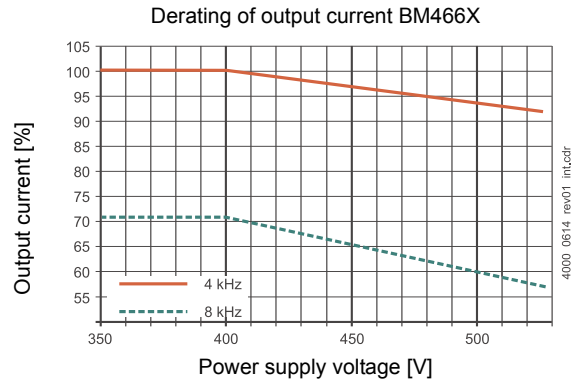

Figure 44: Derating the output current BM466X acceleration units

- 7) The input current must be reduced between 40 °C and 55 °C. Refer to correction factors at changed operating conditions [►Environmental temperature◄](#) on page 59.
- 8) The peak output current is supplied for the maximum peak current period for the motor at the first acceleration (cold power unit). The in fact possible overload time is dependent on the preload of the device and on the heat sink temperature, it is determined by the overload monitoring of the device.
- 9) For cooling versions S and A, only.
- 10) At maximum 4 A, if UL508 C is complied with.
- 11) Refer to [►Motor requirements◄](#) on page 56.
- 12) The range of the output frequency is based on a stationary operation in the linear range of the PWM, i. e. without overmodulation. The quality of the generated output voltages depends on the ratio between output frequency and current controller frequency f_{I-R} ($f_{I-R} = 1/\text{cycle time current controller}$). The maximum output frequency f_{\max} , generated with high quality, is calculated as follows:

$$f_{\max} = \frac{f_{I-R}}{K_{pf}}, \text{ typical } K_{pf} \approx 18$$

Furthermore the controller sets an upper limit for the output frequency of 599 Hz (please contact the responsible Baumüller sales department, keyword: export restriction).

The range of the output frequency is defined as follows:

PWM frequency	Current controller cycle time	Range of the output frequency
2 kHz	250 μ s	0 - 225 Hz
4 kHz/8 kHz	125 μ s	0 - 450 Hz

The controller allows the device to generate output voltages with frequencies between f_{\max} and 599 Hz. However the quality of this voltages cannot be guaranteed.

Typical the devices are marked with the max output frequency at 4 kHz switching frequency: 0 ... 450 kHz.

- 13) The continuously permitted output current must be reduced complying with [►Output frequency dependent maximum current derating BM46XX◄](#) on page 117, if the static output frequency is lower than 15 Hz and the frequency remains between 0 and 15 Hz for over 5 seconds.
- 14) The device is available in cooling type „Z“ and „F“ with standard size (BM46XX-XXX-0XXXX) or short size (BM46XX-XXX-3XXXX).
- 15) The motor connection of the device provides a limited short-circuit protection.
- 16) The sum of the mean effective power transfer via the DC link terminals and at the motor terminals, may not exceed continuously the rated input power of the device. In addition the mean effective power transfer via the DC link terminals to further devices is limited to the specified value.

3.4.3 Electrical data BM47XX continuous current units

	BM4755 ¹⁴⁾	BM4766 ¹⁴⁾	BM4773
Rated input power ¹⁾²⁾	139 kVA	306 kVA	475 kVA
Rated input current ¹⁾²⁾ (I _{eff})	190 A	442 A	685 A
Total harmonic distortion input current ¹⁾²⁾ (THD _I)	40 %	50%	54 %
Max. input current ²⁾ (I _{eff})	380 A	455 A	772 A
Rated DC link voltage ¹⁾	540 V _{DC}		
DC link capacitance (internal)	6600 μF	13200 μF	19,8 mF
DC link capacitance (external), permitted	refer to Page 233		
DC link discharging time (internal DC link capacitance)	140 s	280 s	150 s
Capacitance DC link to PE	240 nF		
Waiting time between two power up processes	no		
Output voltage ¹⁾³⁾ (U _{AC})	3 x 0 V to 3 x 370 V		
Output frequency at 4 kHz ¹²⁾	0 Hz to 450 Hz		
Rated output current ¹⁾⁵⁾⁶⁾⁷⁾¹⁴⁾ (I _{AC}) at 4 kHz ⁴⁾	260 A	450 A	720 A
Rated output current ¹⁾⁵⁾⁶⁾⁷⁾¹⁴⁾ (I _{AC}) at 8 kHz ⁴⁾	185 A	305 A	495 A
Output peak current ¹⁾⁵⁾⁶⁾⁸⁾¹⁴⁾ (I _{AC}) at 4 kHz ⁴⁾	260 A	450 A	800 A
Output peak current ¹⁾⁵⁾⁶⁾⁸⁾¹⁴⁾ (I _{AC}) at 8 kHz ⁴⁾	185 A	305 A	545 A
Max. peak current period ⁸⁾	not limited		60 s
Connected load DC link terminals ¹⁵⁾	-	Max. 160 kW	Max. 360 kW
Brake resistor current, permitted (Î)	-	Max. 236 A	Max. 300 A
Brake resistor external	≥ 5 Ω	≥ 3,33 Ω	≥ 2,6 Ω
Brake resistor threshold (Û) ¹¹⁾	780 V		
Brake resistor peak power	120 kW	183 kW	234 kW
Permitted continuous power brake resistor external	80 kW	130 kW	180 kW
Power loss referring to power input	3000 W	4800 W	7800 W
Power input referring to control voltage	Max. 75 W	Max. 80 W	Max. 170 W
Power input of the device fan referring to 230 V _{AC} ⁹⁾	190 W	174 W	-
Current of integrated brake control	Max. 8,0 A ¹⁰⁾		
Cooling air requirement device internal space	135 m ³ /h	200 m ³ /h	
Requirement to the water cooling	Refer to Page 63		

1) All rated values refer to a DC link voltage of 540 V, a control voltage of 24 V and an environmental temperature of 40 °C.

2) Using the power choke listed in [Power chokes](#) on page 306 at a power supply with U_{K,power supply} = 0.4 %.

3.4 Electrical data basic units

- 3) The output voltage is a pulsed DC voltage. The operating range refers to the RMS of the fundamental wave.

$$U_{AC} = 3 \times 0 \text{ V to } 3 \times \left(\frac{U_{DC}}{\sqrt{2}} - 10 \text{ V} \right) \text{ without overmodulation of the PWM.}$$

- 4) Switching frequency of the inverter (adjustable).
 5) RMS at an environmental temperature of 40 °C.
 6) At rated power supply voltage the unit supplies rated / maximum output currents. With input voltages above the rated power supply voltage the output currents must be reduced at constant output power.

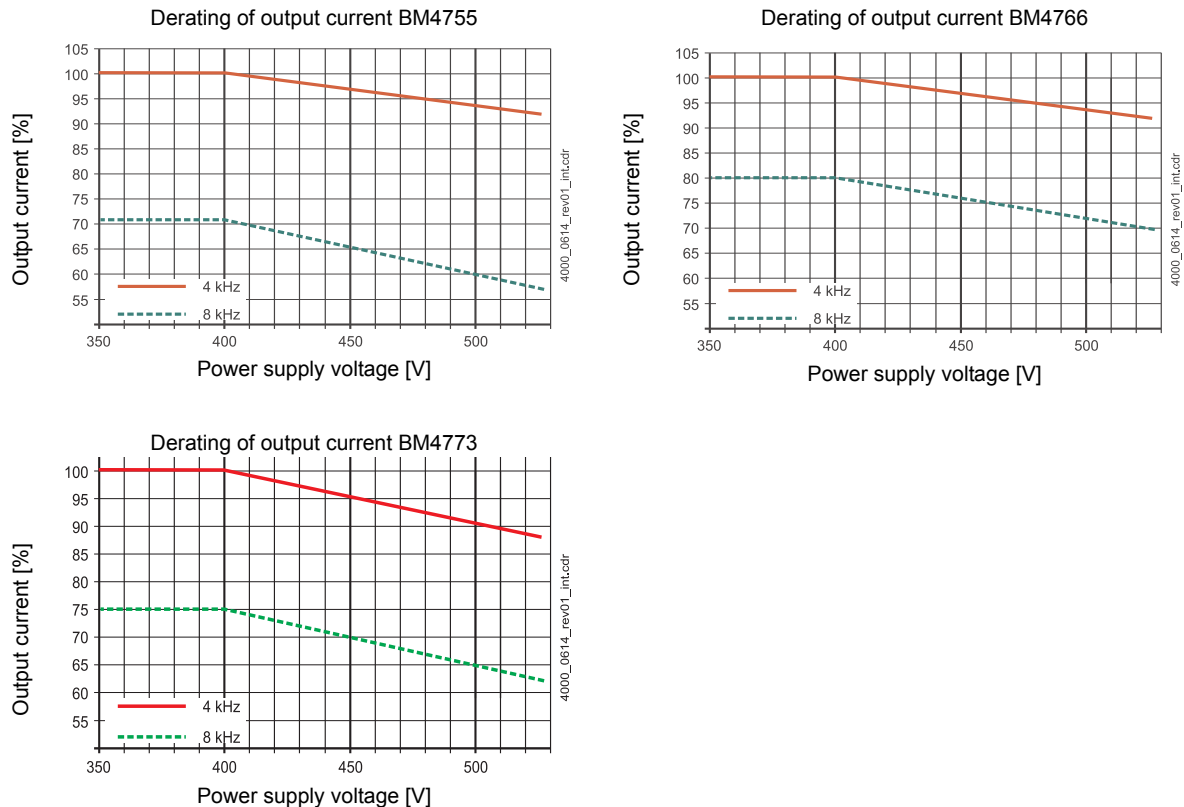

Figure 45: Derating the output current BM47XX continuous current units

- 7) The input current must be reduced between 40 °C and 55 °C. Refer to correction factors at changed operating conditions [►Environmental temperature◄](#) on page 59.
- 8) The peak output current is supplied for the maximum peak current period for the motor at the first acceleration (cold power unit). The in fact possible overload time is dependent on the preload of the device and on the heat sink temperature, it is determined by the overload monitoring of the device.
- 9) For cooling versions S and A, only.
- 10) At maximum 4 A, if UL508 C is complied with.
- 11) Refer to [►Motor requirements◄](#) on page 56.

- ¹²⁾The range of the output frequency is based on a stationary operation in the linear range of the PWM, i. e. without overmodulation. The quality of the generated output voltages depends on the ratio between output frequency and current controller frequency f_{I-R} ($f_{I-R} = 1/\text{cycle time current controller}$). The maximum output frequency f_{max} , generated with high quality, is calculated as follows:

$$f_{max} = \frac{f_{I-R}}{K_{pf}}, \text{ typical } K_{pf} \approx 18$$

Furthermore the controller sets an upper limit for the output frequency of 599 Hz (please contact the responsible Baumüller sales department, keyword: export restriction).

The range of the output frequency is defined as follows:

PWM frequency	Current controller cycle time	Range of the output frequency
2 kHz	250 μ s	0 - 225 Hz
4 kHz/8 kHz	125 μ s	0 - 450 Hz

The controller allows the device to generate output voltages with frequencies between f_{max} and 599 Hz. However the quality of this voltages cannot be guaranteed.

Typical the devices are marked with the max output frequency at 4 kHz switching frequency: 0 ... 450 kHz.

- ¹³⁾The continuously permitted output current must be reduced complying with [▶Output frequency dependent continuous current derating BM4XXX](#) on page 116, if the statical output frequency is lower than 15 Hz and the frequency remains between 0 and 15 Hz for over 5 seconds.
- ¹⁴⁾The device is available in cooling type „Z“ and „F“ with standard size (BM47XX-XXX-0XXXX) or short size (BM47XX-XXX-3XXXX).
- ¹⁵⁾The sum of the mean effective power transfer via the DC link terminals and at the motor terminals, may not exceed continuously the rated input power of the device. In addition the mean effective power transfer via the DC link terminals to further devices is limited to the specified value.

3.5 Electrical data power modules

3.5.1 Electrical data BM442X power modules

	BM4422- XXX - 2XXXX	BM4423 - XXX - 2XXXX	BM4424 - XXX - 2XXXX	BM4425 - XXX - 2XXXX	
Rated input power ¹⁾	4.3 kW	6.2 kW	8.2 kW	8.2 kW	
Rated input current ¹⁾ (I _{eff})	7.8 A	11.5 A	15.2 A	15.2 A	
Max. input current (I _{eff})	15.5 A	23.0 A	30.4 A	40.6 A	
Rated DC link voltage ¹⁾ (U _{DC})	540 V _{DC}				
DC link capacitance (internal)	470 µF		705 µF		
DC link discharging time (internal DC link capacitance)	340 s		510 s		
Output voltage ¹⁾²⁾ (U _{AC})	3 x 0 V to 3 x 370 V				
Output frequency at 4 kHz ⁸⁾	0 Hz to 450 Hz				
Rated output current ¹⁾⁴⁾⁵⁾⁶⁾⁹⁾ (I _{AC})	at 4 kHz ³⁾	7.5 A	11.0 A	15.0 A	15.0 A
Rated output current ¹⁾⁴⁾⁵⁾⁶⁾⁹⁾ (I _{AC})	at 8 kHz ³⁾	6.0 A	8.8 A	12.0 A	12.0 A
Output peak current ¹⁾⁴⁾⁶⁾⁷⁾⁹⁾ (I _{AC})	at 4 kHz ³⁾	15.0 A	22.0 A	30.0 A	40.0 A
Output peak current ¹⁾⁴⁾⁶⁾⁷⁾⁹⁾ (I _{AC})	at 8 kHz ³⁾	12.0 A	17.6 A	24.0 A	32.0 A
Max. peak current period ⁷⁾	60 s			1 s	
Power loss referring to power input	83 W	122 W	166 W		
Power input referring to control voltage	Max. 63 W				
Current of the integrated brake control	Max. 2.0 A				

¹⁾ All rated values refer to a DC link voltage of 540 V_{DC} and a control voltage of 24 V.

²⁾ The output voltage is a pulsed DC voltage. The operating range refers to the RMS of the fundamental wave.

$$U_{AC} = 3 \times 0 \text{ V to } 3 \times \left(\frac{U_{DC}}{\sqrt{2}} - 10 \text{ V} \right) \text{ without overmodulation of the PWM.}$$

³⁾ Switching frequency of the inverter (adjustable).

⁴⁾ RMS at an environmental temperature of 40 °C.

⁵⁾ The input current must be reduced between 40 °C and 55 °C. Refer to correction factors at changed operating conditions [►Environmental temperature◀](#) on page 59.

6) At rated power supply voltage the unit supplies rated / maximum output currents. With input voltages above the rated power supply voltage the output currents must be reduced at constant output power.

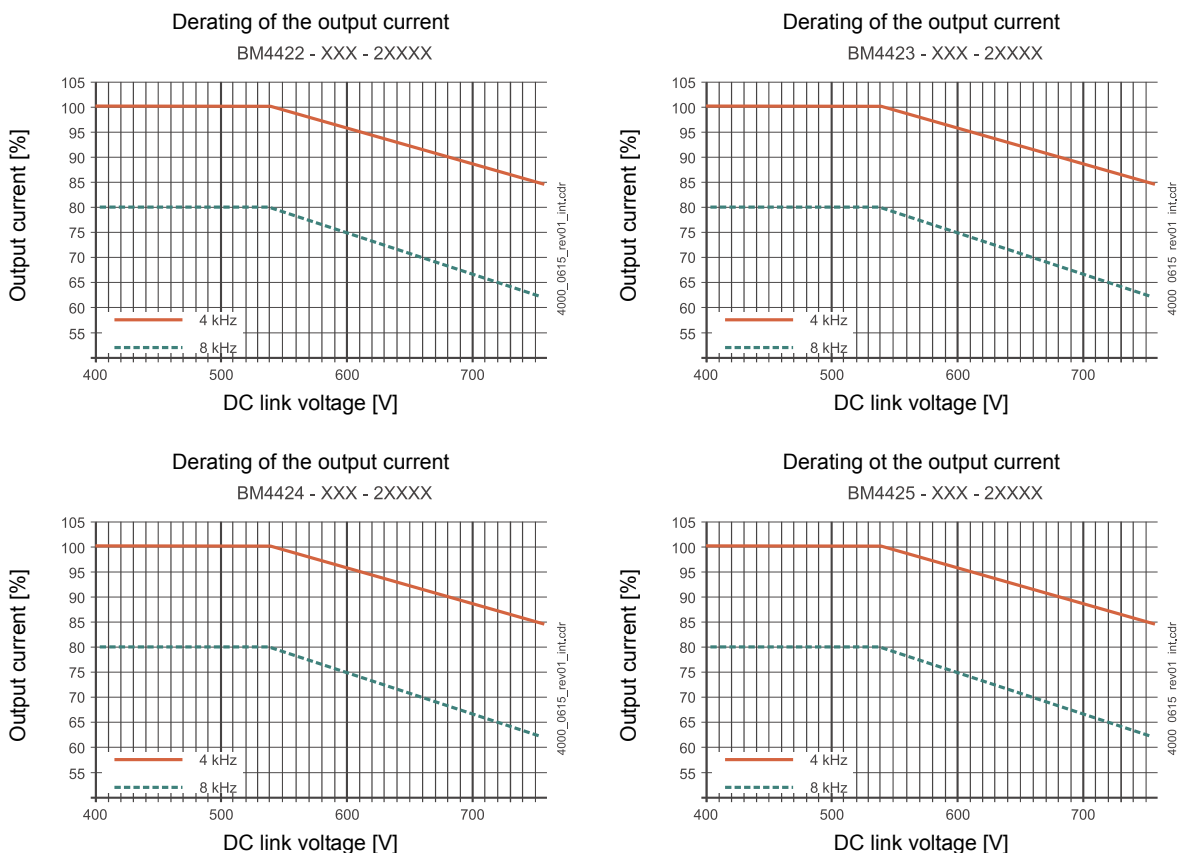

Figure 46: Derating the output current BM442X power modules

7) The peak output current is supplied for the maximum peak current period for the motor at the first acceleration (cold power unit). The in fact possible overload time is dependent on the preload of the device and on the heat sink temperature, it is determined by the overload monitoring of the device.

8) The range of the output frequency is based on a stationary operation in the linear range of the PWM, i. e. without overmodulation. The quality of the generated output voltages depends on the ratio between output frequency and current controller frequency f_{I-R} ($f_{I-R} = 1/\text{cycle time current controller}$).

The maximum output frequency f_{max} , generated with high quality, is calculated as follows:

$$f_{max} = \frac{f_{I-R}}{K_{pf}}, \text{ typical } K_{pf} \approx 18$$

Furthermore the controller sets an upper limit for the output frequency of 599 Hz (please contact the responsible Baumüller sales department, keyword: export restriction).

The range of the output frequency is defined as follows:

PWM frequency	Current controller cycle time	Range of the output frequency
2 kHz	250 μ s	0 - 225 Hz
4 kHz/8 kHz	125 μ s	0 - 450 Hz

The controller allows the device to generate output voltages with frequencies between f_{max} and 599 Hz. However the quality of this voltages cannot be guaranteed.

Typical the devices are marked with the max output frequency at 4 kHz switching frequency: 0 ... 450 kHz.

9) The continuously permitted output current must be reduced complying with [▶Output frequency dependent continuous current derating BM4XXX◀](#) on page 116, if the static output frequency is lower than 15 Hz and the frequency remains between 0 and 15 Hz for over 5 seconds.

3.5 Electrical data power modules

3.5.2 Electrical data BM443X power modules

	BM4432- XXX - 2XXXX	BM4433 - XXX - 2XXXX	BM4434 - XXX - 2XXXX	BM4435 - XXX - 2XXXX	
Rated input power ¹⁾	12.0 kW	15.3 kW	23.3 kW	32.3 kW	
Rated input current ¹⁾ (I _{eff})	22.3 A	28.4 A	43.2 A	59.8 A	
Max. input current (I _{eff})	44.7 A	56.8 A	86.4 A	89.7 A	
Rated DC link voltage ¹⁾ (U _{DC})	540 V _{DC}				
DC link capacitance (internal)	820 µF	1230 µF	1640 µF	2000 µF	
DC link discharging time (internal DC link capacitance)	140 s	210 s	280 s	340 s	
Output voltage ¹⁾²⁾ (U _{AC})	3 x 0 V to 3 x 370 V				
Output frequency at 4 kHz ⁸⁾	0 Hz to 450 Hz				
Rated output current ¹⁾⁴⁾⁵⁾⁶⁾⁹⁾ (I _{AC})	at 4 kHz ³⁾	22.5 A	30.0 A	45.0 A	60.0 A
Rated output current ¹⁾⁴⁾⁵⁾⁶⁾⁹⁾ (I _{AC})	at 8 kHz ³⁾	18.0 A	24.0 A	36.0 A	48.0 A
Output peak current ¹⁾⁴⁾⁶⁾⁷⁾⁹⁾ (I _{AC})	at 4 kHz ³⁾	45.0 A	60.0 A	90.0 A	90.0 A
Output peak current ¹⁾⁴⁾⁶⁾⁷⁾⁹⁾ (I _{AC})	at 8 kHz ³⁾	36.0 A	48.0 A	72.0 A	72.0 A
Max. peak current period ⁷⁾	60 s				
Power loss referring to the power input	250 W	318 W	490 W	685 W	
Power input referring to the control voltage	Max. 88 W				
Current of the integrated brake control	Max. 8.0 A ¹⁰⁾				

¹⁾ All rated values refer to a DC link voltage of 540 V_{DC} and a control voltage of 24 V.

²⁾ The output voltage is a pulsed DC voltage. The operating range refers to the RMS of the fundamental wave.

$$U_{AC} = 3 \times 0 \text{ V to } 3 \times \left(\frac{U_{DC}}{\sqrt{2}} - 10 \text{ V} \right) \text{ without overmodulation of the PWM.}$$

³⁾ Switching frequency of the inverter (adjustable).

⁴⁾ RMS at an environmental temperature of 40 °C.

⁵⁾ The input current must be reduced between 40 °C and 55 °C. Refer to correction factors at changed operating conditions [► Environmental temperature ◀](#) on page 59.

6) At rated power supply voltage the unit supplies rated / maximum output currents. With input voltages above the rated power supply voltage the output currents must be reduced at constant output power.

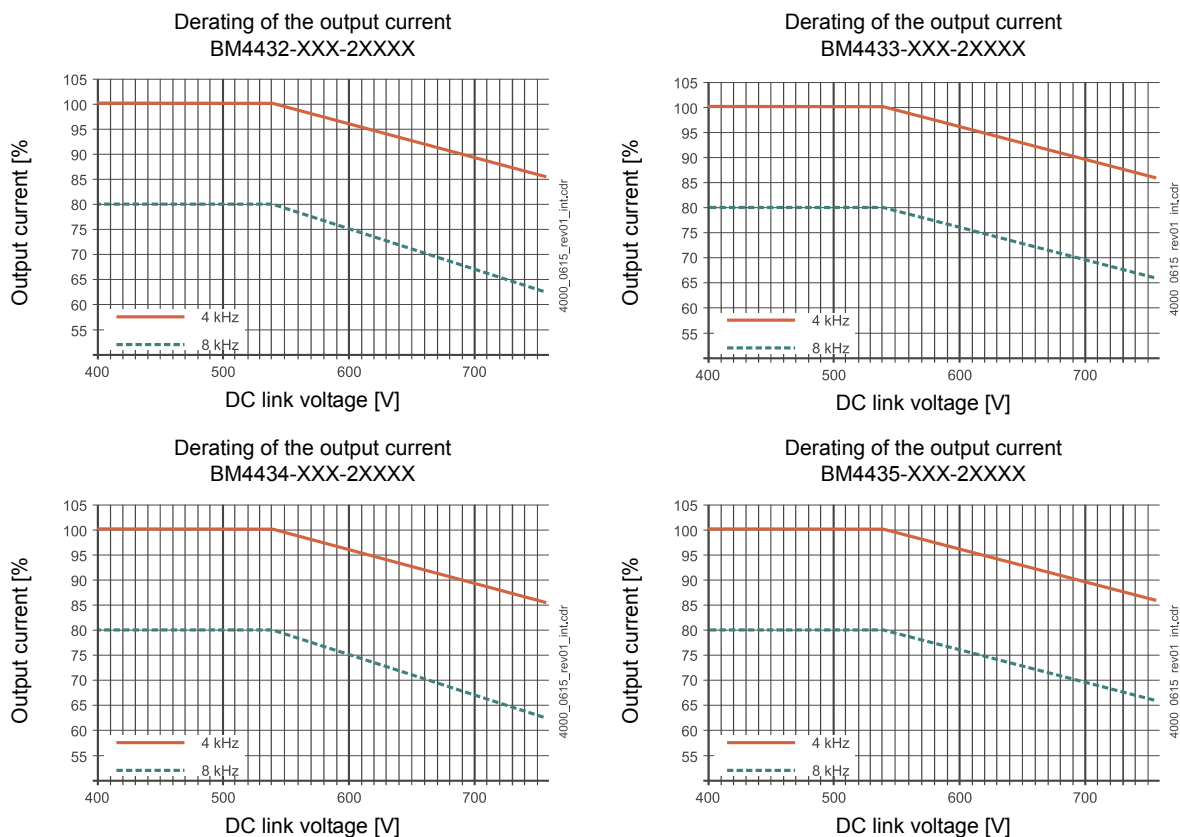

Figure 47: Derating the output current BM443X power modules

7) The peak output current is supplied for the maximum peak current period for the motor at the first acceleration (cold power unit). The in fact possible overload time is dependent on the preload of the device and on the heat sink temperature, it is determined by the overload monitoring of the device.

8) The range of the output frequency is based on a stationary operation in the linear range of the PWM, i. e. without overmodulation. The quality of the generated output voltages depends on the ratio between output frequency and current controller frequency f_{I-R} ($f_{I-R} = 1/\text{cycle time current controller}$).

The maximum output frequency f_{max} , generated with high quality, is calculated as follows:

$$f_{max} = \frac{f_{I-R}}{K_{pf}}, \text{ typical } K_{pf} \approx 18$$

Furthermore the controller sets an upper limit for the output frequency of 599 Hz (please contact the responsible Baumüller sales department, keyword: export restriction).

The range of the output frequency is defined as follows:

PWM frequency	Current controller cycle time	Range of the output frequency
2 kHz	250 μ s	0 - 225 Hz
4 kHz/8 kHz	125 μ s	0 - 450 Hz

The controller allows the device to generate output voltages with frequencies between f_{max} and 599 Hz. However the quality of this voltages cannot be guaranteed.

Typical the devices are marked with the max output frequency at 4 kHz switching frequency: 0 ... 450 kHz.

9) The continuously permitted output current must be reduced complying with [▶Output frequency dependent continuous current derating BM4XXX◀](#) on page 116, if the stational output frequency is lower than 15 Hz and the frequency remains between 0 and 15 Hz for over 5 seconds.

10) At a hardware status of < 4006 or if UL508C is complied with: at maximum 4 A

3.5 Electrical data power modules

3.5.3 Electrical data BM444X power modules

	BM4443- XXX - 2XXXX	BM4444- XXX - 2XXXX	BM4445 - XXX - 2XXXX	BM4446 - XXX - 2XXXX ⁹⁾
Rated input power ¹⁾	41 kW	50 kW	64 kW	84 kW
Rated input current ¹⁾ (I _{eff})	76 A	93 A	119 A	155 A
Max. input current (I _{eff})	113 A	120 A	155 A	207 A
Rated DC link voltage ¹⁾ (U _{DC})	540 V _{DC}			
DC link capacitance (internal)	1880 µF	2350 µF	3055 µF	3760 µF
DC link discharging time (internal DC link capacitance)	45 s	55 s	70 s	90 s
Output voltage ¹⁾²⁾ (U _{AC})	3 x 0 V to 3 x 370 V			
Output frequency at 4 kHz ¹⁰⁾	0 Hz to 450 Hz			
Rated output current ¹⁾⁴⁾⁵⁾⁷⁾¹²⁾ (I _{AC}) at 4 kHz ³⁾	80 A	100 A	130 A	150 A
Rated output current ¹⁾⁴⁾⁵⁾⁷⁾¹²⁾ (I _{AC}) at 8 kHz ³⁾	75 A	72 A	94 A	105 A
Output peak current ¹⁾⁴⁾⁶⁾⁷⁾¹²⁾ (I _{AC}) at 4 kHz ³⁾	120 A	130 A	170 A	200 A
Output peak current ¹⁾⁴⁾⁶⁾⁷⁾¹²⁾ (I _{AC}) at 8 kHz ³⁾	90 A	94 A	130 A	150 A
Max. peak current period ⁷⁾	60 s			
Power loss referring to the power input	800 W	1000 W	1300 W	1400 W
Power input referring to the control voltage	Max. 75 W			
Power input of the device fan referring to 230 V _{AC} ⁸⁾	87 W			
Current of the integrated brake control	Max. 8.0 A ¹¹⁾			
Cooling air requirement power heat sinks	260 m³/h		210 m³/h	
Cooling air requirement internal space	60 m³/h			

¹⁾ All rated values refer to a DC link voltage of 540 V_{DC} and a control voltage of 24 V.

²⁾ The output voltage is a pulsed DC voltage. The operating range refers to the RMS of the fundamental wave.

$$U_{AC} = 3 \times 0 \text{ V to } 3 \times \left(\frac{U_{DC}}{\sqrt{2}} - 10 \text{ V} \right) \text{ without overmodulation of the PWM.}$$

³⁾ Switching frequency of the inverter (adjustable).

⁴⁾ RMS at an environmental temperature of 40 °C.

⁵⁾ The input current must be reduced between 40 °C and 55 °C. Refer to correction factors at changed operating conditions [►Environmental temperature◀](#) on page 59.

⁶⁾ The peak output current is supplied for the maximum peak current period for the motor at the first acceleration (cold power unit). The in fact possible overload time is dependent on the preload of the device and on the heat sink temperature, it is determined by the overload monitoring of the device.

7) At rated power supply voltage the unit supplies rated / maximum output currents. With input voltages above the rated power supply voltage the output currents must be reduced at constant output power.

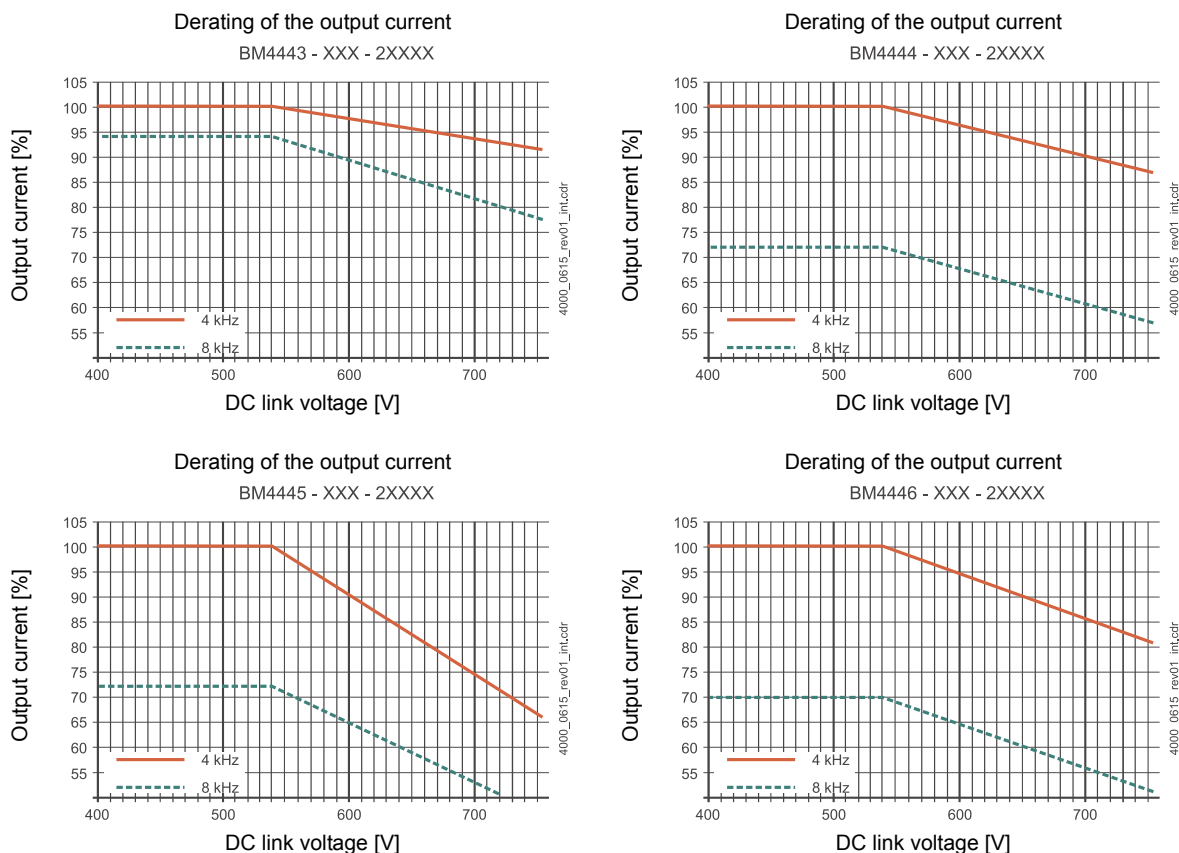

Figure 48: Derating the output current BM444X power modules

- 8) For cooling versions S and A, only.
- 9) **Preliminary information:** Available at devices with type code BM44XX-XXX-XX3XX-03-4-yyy, whereat yyy > 024 and the controller firmware version must be 3.09 or higher.
- 10) The range of the output frequency is based on a stationary operation in the linear range of the PWM, i. e. without overmodulation. The quality of the generated output voltages depends on the ratio between output frequency and current controller frequency f_{I-R} ($f_{I-R} = 1/\text{cycle time current controller}$). The maximum output frequency f_{max} , generated with high quality, is calculated as follows:

$$f_{max} = \frac{f_{I-R}}{K_{pf}}, \text{ typical } K_{pf} \approx 18$$

Furthermore the controller sets an upper limit for the output frequency of 599 Hz (please contact the responsible Baumüller sales department, keyword: export restriction). The range of the output frequency is defined as follows:

PWM frequency	Current controller cycle time	Range of the output frequency
2 kHz	250 μ s	0 - 225 Hz
4 kHz/8 kHz	125 μ s	0 - 450 Hz

The controller allows the device to generate output voltages with frequencies between f_{max} and 599 Hz. However the quality of this voltages cannot be guaranteed.

Typical the devices are marked with the max output frequency at 4 kHz switching frequency: 0 ... 450 kHz.

- 11) At a hardware status of < 4006 or if UL508C is complied with: at maximum 4 A
- 12) The continuously permitted output current must be reduced complying with [▶Output frequency dependent continuous current derating BM4XXX◀](#) on page 116, if the stactical output frequency is lower than 15 Hz and the frequency remains between 0 and 15 Hz for over 5 seconds.

3.5 Electrical data power modules

3.5.4 Electrical data BM445X power modules

	BM4452- XXX - 2XXXX	BM4453- XXX - 2XXXX	BM4454- XXX - 2XXXX	
Rated input power ¹⁾	68 kW	85 kW	125 kW	
Rated input current ¹⁾ (I _{eff})	126 A	158 A	232 A	
Max. input current (I _{eff})	164 A	206 A	302 A	
Rated DC link voltage ¹⁾ (U _{DC})	540 V _{DC}			
DC link capacitance (internal)	3000 µF		6600 µF	
DC link discharging time (internal DC link capacitance)	75 s		140 s	
Output voltage ¹⁾²⁾ (U _{AC})	3 x 0 V bis 3 x 370 V			
Output frequency at 4 kHz ⁹⁾	0 Hz bis 450 Hz			
Rated output current ¹⁾⁴⁾⁵⁾⁶⁾¹⁰⁾ (I _{AC})	at 4 kHz ³⁾	120 A	150 A	210 A
Rated output current ¹⁾⁴⁾⁵⁾⁶⁾¹⁰⁾ (I _{AC})	at 8 kHz ³⁾	96 A	116 A	150 A
Output peak current ¹⁾⁴⁾⁵⁾⁷⁾¹⁰⁾ (I _{AC})	at 4 kHz ³⁾	180 A	195 A	260 A
Output peak current ¹⁾⁴⁾⁵⁾⁷⁾¹⁰⁾ (I _{AC})	at 8 kHz ³⁾	144 A	150 A	185 A
Max. peak current period ⁷⁾	60 s			
Power loss referring to the power input	1470 W	1860 W	2690 W	
Power input referring to the control voltage	Max. 75 W			
Power input of the device fan referring to 230 V _{AC} ⁸⁾	190 W			
Current of the integrated brake control	Max. 8.0 A ⁹⁾			
Cooling air requirement power heat sinks	450 m³/h			
Cooling air requirement device internal space	135 m³/h			

¹⁾ All rated values refer to a DC link voltage of 540 V_{DC} and a control voltage of 24 V.

²⁾ The output voltage is a pulsed DC voltage. The operating range refers to the RMS of the fundamental wave.

$$U_{AC} = 3 \times 0 \text{ V to } 3 \times \left(\frac{U_{DC}}{\sqrt{2}} - 10 \text{ V} \right) \text{ without overmodulation of the PWM.}$$

³⁾ Switching frequency of the inverter (adjustable).

⁴⁾ RMS at an environmental temperature of 40 °C.

- 5) At rated power supply voltage the unit supplies rated / maximum output currents. With input voltages above the rated power supply voltage the output currents must be reduced at constant output power.

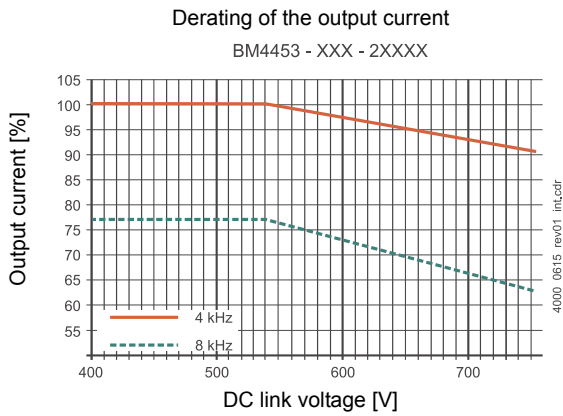

Figure 49: Derating the output current BM445X power modules

- 6) The input current must be reduced between 40 °C and 55 °C. Refer to correction factors at changed operating conditions [►Environmental temperature◄](#) on page 59.
- 7) The peak output current is supplied for the maximum peak current period for the motor at the first acceleration (cold power unit). The in fact possible overload time is dependent on the preload of the device and on the heat sink temperature, it is determined by the overload monitoring of the device.
- 8) For cooling versions S and A, only.
- 9) The range of the output frequency is based on a stationary operation in the linear range of the PWM, i. e. without overmodulation. The quality of the generated output voltages depends on the ratio between output frequency and current controller frequency f_{I-R} ($f_{I-R} = 1/\text{cycle time current controller}$). The maximum output frequency f_{max} , generated with high quality, is calculated as follows:

$$f_{max} = \frac{f_{I-R}}{K_{pf}}, \text{ typical } K_{pf} \approx 18$$

Furthermore the controller sets an upper limit for the output frequency of 599 Hz (please contact the responsible Baumüller sales department, keyword: export restriction).

The range of the output frequency is defined as follows:

PWM frequency	Current controller cycle time	Range of the output frequency
2 kHz	250 µs	0 - 225 Hz
4 kHz/8 kHz	125 µs	0 - 450 Hz

The controller allows the device to generate output voltages with frequencies between f_{max} and 599 Hz. However the quality of this voltages cannot be guaranteed.

Typical the devices are marked with the max output frequency at 4 kHz switching frequency: 0 ... 450 kHz.

- 10) The continuously permitted output current must be reduced complying with [►Output frequency dependent continuous current derating BM4XXX◄](#) on page 116, if the stational output frequency is lower than 15 Hz and the frequency remains between 0 and 15 Hz for over 5 seconds.

3.5 Electrical data power modules

3.5.5 Electrical data BM446X power module

	BM4462- XXX - 2XXXX	BM4463- XXX - 2XXXX
Rated input power ¹⁾	150 kW	180 kW
Rated input current ¹⁾ (I _{eff})	278 A	335 A
Max. input current (I _{eff})	392 A	436 A
Rated DC link voltage ¹⁾ (U _{DC})	540 V _{DC}	
DC link capacitance (internal)	6000 µF	
DC link discharging time (internal DC link capacitance)	150 s	
Output voltage ¹⁾²⁾ (U _{AC})	3 x 0 V to 3 x 370 V	
Output frequency at 4 kHz ¹⁰⁾	0 Hz to 450 Hz	
Rated output current ¹⁾⁴⁾⁵⁾⁶⁾¹¹⁾ (I _{AC})	at 4 kHz ³⁾ 250 A	300 A
Rated output current ¹⁾⁴⁾⁵⁾⁶⁾¹¹⁾ (I _{AC})	at 8 kHz ³⁾ 200 A	240 A
Output peak current ¹⁾⁴⁾⁵⁾⁷⁾¹¹⁾ (I _{AC})	at 4 kHz ³⁾ 325 A	390 A
Output peak current ¹⁾⁴⁾⁵⁾⁷⁾¹¹⁾ (I _{AC})	at 8 kHz ³⁾ 260 A	312 A
Max. peak current period ⁷⁾	60 s	
Power loss referring to the power input	3230 W	3920 W
Power input referring to the control voltage	Max. 80 W	
Power input of the device fan referring to 230 V _{AC} ⁸⁾	174 W	
Current of the integrated brake control	Max. 8.0 A ⁹⁾	
Cooling air requirement power heat sinks	450 m³/h	
Cooling air requirement device internal space	200 m³/h	

¹⁾ All rated values refer to a DC link voltage of 540 V_{DC} and a control voltage of 24 V.

²⁾ The output voltage is a pulsed DC voltage. The operating range refers to the RMS of the fundamental wave.

$$U_{AC} = 3 \times 0 \text{ V to } 3 \times \left(\frac{U_{DC}}{\sqrt{2}} - 10 \text{ V} \right) \text{ without overmodulation of the PWM.}$$

³⁾ Switching frequency of the inverter (adjustable).

⁴⁾ RMS at an environmental temperature of 40 °C.

⁵⁾ At rated power supply voltage the unit supplies rated / maximum output currents. With input voltages above the rated power supply voltage the output currents must be reduced at constant output power

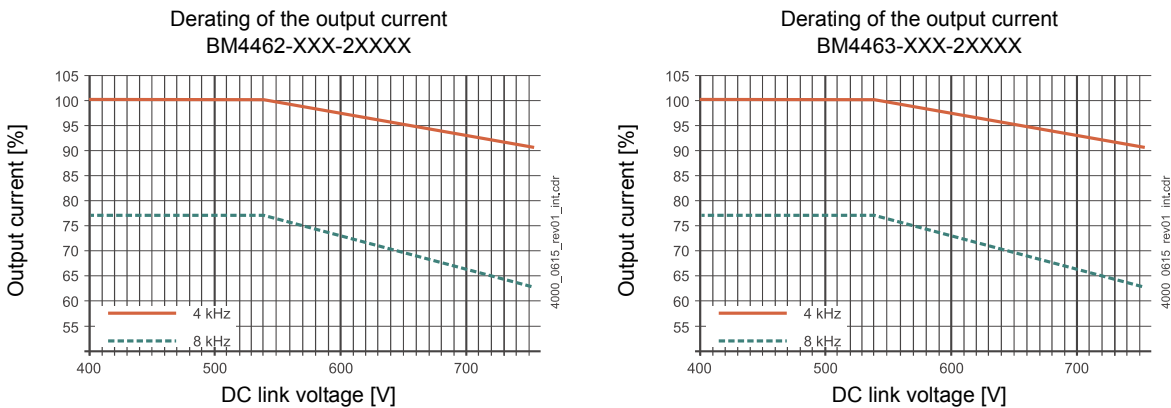

Figure 50: Derating the output current BM446X power modules

- 6) The input current must be reduced between 40 °C and 55 °C. Refer to correction factors at changed operating conditions [►Environmental temperature◄](#) on page 59.
- 7) The peak output current is supplied for the maximum peak current period for the motor at the first acceleration (cold power unit). The in fact possible overload time is dependent on the preload of the device and on the heat sink temperature, it is determined by the overload monitoring of the device.
- 8) For cooling versions S and A, only.
- 9) If UL508C is complied with: max. 4.0 A.
- 10) The range of the output frequency is based on a stationary operation in the linear range of the PWM, i. e. without overmodulation. The quality of the generated output voltages depends on the ratio between output frequency and current controller frequency f_{I-R} ($f_{I-R} = 1/\text{cycle time current controller}$).

The maximum output frequency f_{max} , generated with high quality, is calculated as follows:

$$f_{max} = \frac{f_{I-R}}{K_{Pf}}, \text{ typical } K_{Pf} \approx 18$$

Furthermore the controller sets an upper limit for the output frequency of 599 Hz (please contact the responsible Baumüller sales department, keyword: export restriction).

The range of the output frequency is defined as follows:

PWM frequency	Current controller cycle time	Range of the output frequency
2 kHz	250 μ s	0 - 225 Hz
4 kHz/8 kHz	125 μ s	0 - 450 Hz

The controller allows the device to generate output voltages with frequencies between f_{max} and 599 Hz. However the quality of this voltages cannot be guaranteed.

Typical the devices are marked with the max output frequency at 4 kHz switching frequency: 0 ... 450 kHz.

- 11) The continuously permitted output current must be reduced complying with [►Output frequency dependent continuous current derating BM4XXX◄](#) on page 116, if the stational output frequency is lower than 15 Hz and the frequency remains between 0 and 15 Hz for over 5 seconds.

3.5 Electrical data power modules

3.5.6 Electrical data BM447X power module

	BM4472 - XXX - 2XXXX	BM4473 - XXX - 2XXXX ¹³⁾
Rated input power ¹⁾	160 kW	220 kW
Rated input current ¹⁾ (I _{eff})	300 A	410 A
Max. input current (I _{eff})	450 A	535 A
Rated DC link voltage ¹⁾ (U _{DC})	540 V _{DC}	
DC link capacitance (internal)	19,8 mF	
DC link discharging time (internal DC link capacitance)	150 s	
Output voltage ¹⁾²⁾ (U _{AC})	3 x 0 V to 3 x 370 V	
Output frequency at 4 kHz ¹⁾	0 Hz to 450 Hz	
Rated output current ¹⁾⁴⁾⁵⁾⁶⁾¹⁰⁾ (I _{AC}) at 4 kHz ³⁾	450 A	615 A
Rated output current ¹⁾⁴⁾⁵⁾⁶⁾¹⁰⁾ (I _{AC}) at 8 kHz ³⁾	338 A	420 A
Output peak current ¹⁾⁴⁾⁵⁾⁷⁾¹²⁾ (I _{AC}) at 4 kHz ³⁾	585 A	800 A
Output peak current ¹⁾⁴⁾⁵⁾⁷⁾¹²⁾ (I _{AC}) at 8 kHz ³⁾	439 A	545 A
Max. peak current period ⁷⁾	60 s	
Power loss referring to the power input	4700 W	6450 W
Power input referring to the control voltage	116 W	
Power input of the device fan referring to 230 V _{AC} ⁸⁾	Max. 540 W	
Current of the integrated brake control	Max. 8,0 A ⁹⁾	
Cooling air requirement power heat sinks	1000 m ³ /h	
Cooling air requirement device internal space	250 m ³ /h	

¹⁾ All rated values refer to a DC link voltage of 540 V_{DC} and a control voltage of 24 V.

²⁾ The output voltage is a pulsed DC voltage. The operating range refers to the RMS of the fundamental wave.

$$U_{AC} = 3 \times 0 \text{ V to } 3 \times \left(\frac{U_{DC}}{\sqrt{2}} - 10 \text{ V} \right) \text{ without overmodulation of the PWM.}$$

³⁾ Switching frequency of the inverter (adjustable).

⁴⁾ RMS at an environmental temperature of 40 °C.

- 5) At rated power supply voltage the unit supplies rated / maximum output currents. With input voltages above the rated power supply voltage the output currents must be reduced at constant output power

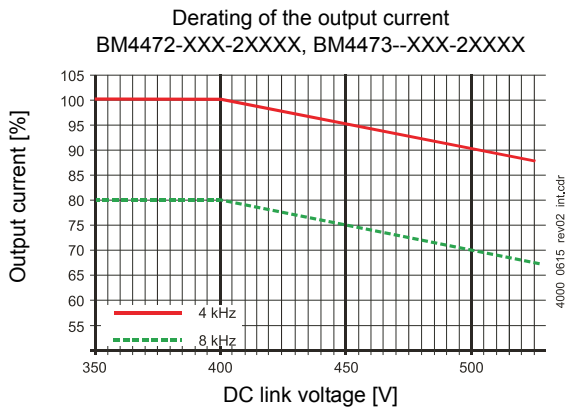

Figure 51: Derating the output current BM446X power modules

- 6) The input current must be reduced between 40 °C and 55 °C. Refer to correction factors at changed operating conditions [► Environmental temperature ◄](#) on page 59.
- 7) The peak output current is supplied for the maximum peak current period for the motor at the first acceleration (cold power unit). The in fact possible overload time is dependent on the preload of the device and on the heat sink temperature, it is determined by the overload monitoring of the device.
- 8) For cooling versions S and A, only.
- 9) If UL508C is complied with: max. 4.0 A.
- 10) If UL508C is complied with:
 The permitted typical motor output is limited to 295 kW at a maximum. The device BM5573 belongs to the category < 400 HP, < 298 kW ratings complying with table 45.1 of UL508C. Therefore, the short-circuit test using 18k A can be executed. Baumüller does not offer devices in the class 600 HP, 447 kW with 30 kA short-circuit current in accordance with UL508C.
- 11) The range of the output frequency is based on a stationary operation in the linear range of the PWM, i. e. without overmodulation. The quality of the generated output voltages depends on the ratio between output frequency and current controller frequency f_{I-R} ($f_{I-R} = 1/\text{cycle time current controller}$).
 The maximum output frequency f_{max} , generated with high quality, is calculated as follows:

$$f_{max} = \frac{f_{I-R}}{K_{pf}}, \text{ typical } K_{pf} \approx 18$$

Furthermore the controller sets an upper limit for the output frequency of 599 Hz (please contact the responsible Baumüller sales department, keyword: export restriction).

The range of the output frequency is defined as follows:

PWM frequency	Current controller cycle time	Range of the output frequency
2 kHz	250 µs	0 - 225 Hz
4 kHz/8 kHz	125 µs	0 - 450 Hz

The controller allows the device to generate output voltages with frequencies between f_{max} and 599 Hz. However the quality of this voltages cannot be guaranteed.

Typical the devices are marked with the max output frequency at 4 kHz switching frequency: 0 ... 450 kHz.

- 12) The continuously permitted output current must be reduced complying with [► Output frequency dependent continuous current derating BM4XXX ◄](#) on page 116, if the statical output frequency is lower than 15 Hz and the frequency remains between 0 and 15 Hz for over 5 seconds.
- 13) Please contact Baumüller Nürnberg if you need a higher power output.

3.6 Additional data referring to water-cooled brake resistors

Technical data brake resistors

Device version	Brake resistor	Additional device weight	Brake resistor current	Depth of device ¹⁾	Brake peak power P_{Smax} ³⁾	Brake continuous power P_{Dmax} ^{2) 3)}	Constants for calculation		
							C_1	C_2	C_3
BM4434-ZIX/FIX-XXXXXR16 BM4435-ZIX/FIX-XXXXXR16 BM4632-ZIX/FIX-XXXXXR16	16 Ω	1.6 kg	49 A	+25 mm	38 kW	2 kW	0.139 K/W	0.05081 K/Ws	-6.7751 s ⁻¹
BM4444-ZIX/FIX-XXXXXR10 BM4445-ZIX/FIX-XXXXXR10 BM4446-ZIX/FIX-XXXXXR10 BM4641-ZIX/FIX-XXXXXR10 BM4642-ZIX/FIX-XXXXXR10	10 Ω	2 x 1.2 kg	78 A	+25 mm	61 kW	1.5 kW	0.200 K/W	0.01605 K/Ws	-0.9169 s ⁻¹
BM445X-ZIX/FIX-XXXXXR05 BM465X-ZIX/FIX-XXXXXR05 BM465X-ZIX/FIX-3XXXXR05 BM475X-FIX-3XXXXR05	5 Ω	4 x 1.2 kg	156 A	+25 mm	122 kW	3 kW	0.100 K/W	0.00802 K/Ws	-0.9169 s ⁻¹
BM446X-ZIX/FIX-XXXXXR03 BM466X-ZIX/FIX-XXXXXR03 BM466X-ZIX/FIX-3XXXXR03 BM476X-FIX-3XXXXR03	3.33 Ω	6 x 1.2 kg	234 A	+25 mm	183 kW	5 kW	0.067 K/W	0.00535 K/Ws	-0.9169 s ⁻¹
BM447X-FIX-XXXXXR03 BM477X-FIX-3XXXXR03	3.33 Ω	6 x 1.2 kg	234 A	+25 mm	183 kW	3.5 kW	0.067 K/W	0.00535 K/Ws	-0.9169 s ⁻¹

- 1) The total depth of the device in the cooling version F increases by the specified value (refer to [►Dimensions◄](#) from page 33). At devices of the cooling version Z the dimensions of the device do not change.
- 2) The DC link voltage must not exceed 800 V.
Calculation of the permitted length of the braking procedure refer to [►Calculations◄](#) from page 111.
- 3) The mentioned continuous power is reached if the water flow amount is at least 10 l/min. The inlet temperature may not be greater than 45 °C.
The brake resistor output power diminishes from the rated value to 0, if the inlet temperature increases from 45°C to 60 °C.



NOTE!

The water-cooled brake resistors offer the optimum of power loss, which can be dissipated, at a minimum unit volume. However, 10 % of the brake resistor power is not dissipated via the cooling water. It is emitted to the environmental air.
At operation with rated power the brake resistors reach temperatures of 200 °C on the rear side.

Preconditions for the cooling versions F/W (through hole devices):

Provide adequate protection against contact. Install grids around the heat sink and the resistors. Assure, that enough air can circulate and that no heat accumulation can develop under the protective cover.

Preconditions for cooling version Z (mounting into the control cabinet):

Install the devices into the control cabinet, that no heat accumulation can develop above the devices. Air circulation must be possible. In spite of air circulation elevated temperatures can occur above the devices. Do not install cables or cable channels above the devices. At the devices BM443X and BM444X do not install the connection cables directly above the mounting plate of the device, where the hot air rises.

When dimensioning, consider that 10 % of brake resistor power is not dissipated via the cooling water, but is an additional power loss, which heats the cabinet. Provide an adequate fresh air supply.

Calculations

Precondition for calculation:

The brake power of the internal brake resistors must decrease straight proportional from the brake peak power to 0.

The brake power time area A must be converted in an equivalent triangular time area. The resulting parameters P_S and t_{on} must be used for the further calculations.

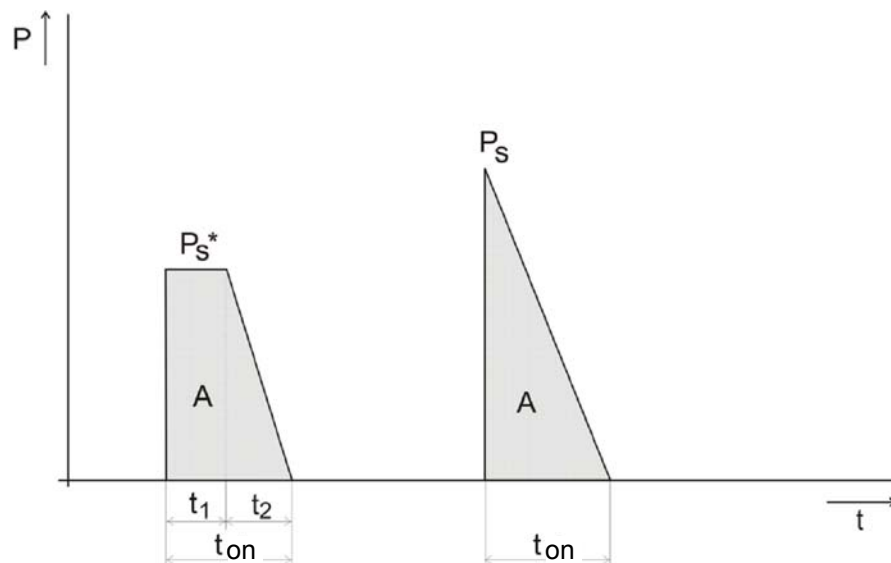

Figure 52: Conversion brake power time area in triangular time area

$$A = t_1 \cdot P^*_S + \frac{1}{2} \cdot t_2 \cdot P^*_S = \frac{1}{2} \cdot t_{on} \cdot P_S$$

3.6 Additional data referring to water-cooled brake resistors

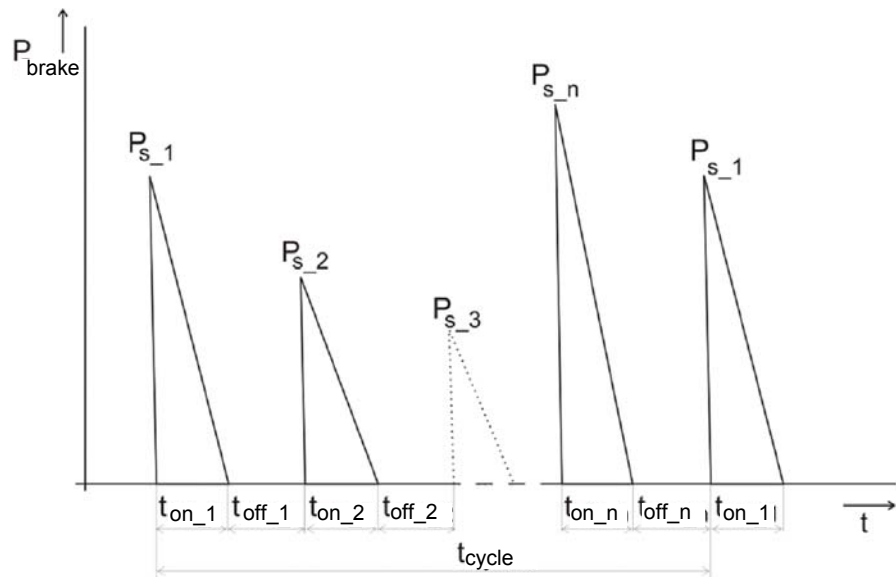
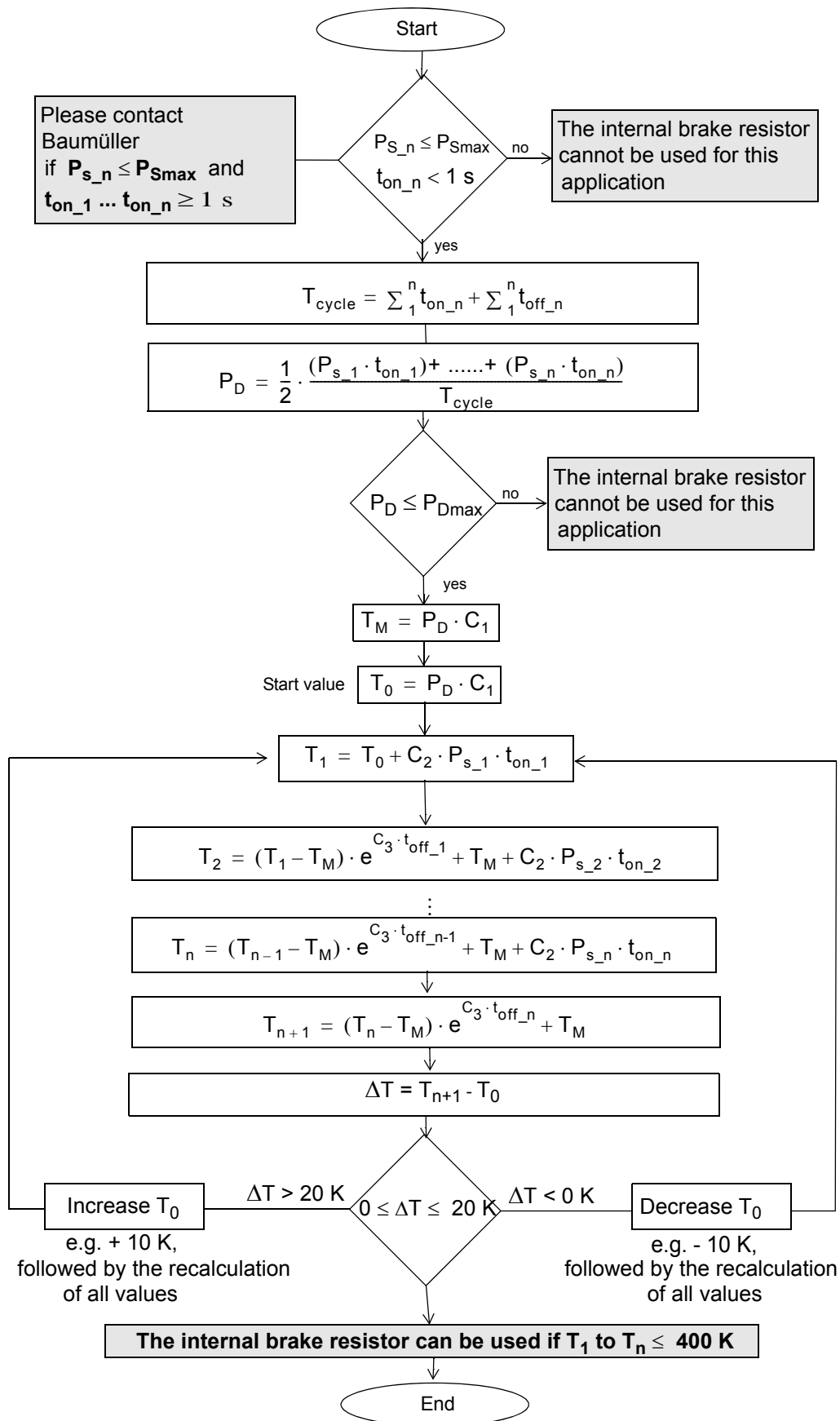

Figure 53: Braking cycle

P_D	Average continuous brake power of one cycle
P_{Dmax}	Maximum continuous brake power, refer to ►Technical data brake resistors◄ on page 110
n	Number of brake operations within one cycle
P_{S_1} to P_{S_n}	Brake peak power, numbered in chronological order
t_{on_1} to t_{on_n}	Brake time periods
t_{off_1} to t_{off_n}	Off time periods, between the brake time periods
T_{cycle}	Total cycle
C_1, C_2, C_3	Constants, refer to ►Technical data brake resistors◄ on page 110



3.6 Additional data referring to water-cooled brake resistors

Example for the calculation of BM4446

Technical data refer to brake resistors on [▶Page 110◀](#).

Device type	Peak power	Continuous power	Constants for calculation		
	$P_{Smax}^{3)}$	$P_{Dmax}^{2)3)}$	C_1	C_2	C_3
BM4446-ZIX/FIX-XXXXXR10	61 kW	1.5 kW	0.2 K/W	0.01605 K/Ws	$-0.9169 s^{-1}$

$n = 5$, refer to brake cycle [▶Figure 53◀](#) on page 112.

P_s	t_{on}	t_{off}
$P_{S_1} = 20 \text{ kW} < 61 \text{ kW}$	$t_{on_1} = 0.15 \text{ s} < 1 \text{ s}$	$t_{off_1} = 1.11 \text{ s}$
$P_{S_2} = 13 \text{ kW} < 61 \text{ kW}$	$t_{on_2} = 0.15 \text{ s} < 1 \text{ s}$	$t_{off_2} = 1.79 \text{ s}$
$P_{S_3} = 20 \text{ kW} < 61 \text{ kW}$	$t_{on_3} = 0.15 \text{ s} < 1 \text{ s}$	$t_{off_3} = 6.85 \text{ s}$
$P_{S_4} = 23 \text{ kW} < 61 \text{ kW}$	$t_{on_4} = 0.15 \text{ s} < 1 \text{ s}$	$t_{off_4} = 1.85 \text{ s}$
$P_{S_5} = 24 \text{ kW} < 61 \text{ kW}$	$t_{on_5} = 0.15 \text{ s} < 1 \text{ s}$	$t_{off_5} = 5.65 \text{ s}$

$$T_{\text{cycle}} = \sum_1^n t_{on_n} + \sum_1^n t_{off_n} = 5 \cdot 0.15 \text{ s} + 1.11 \text{ s} + 1.79 \text{ s} + 6.85 \text{ s} + 1.85 \text{ s} + 5.65 \text{ s} = \mathbf{18 \text{ s}}$$

$$P_D = \frac{1}{2} \cdot \frac{(P_{s_1} \cdot t_{ein_1}) + \dots + (P_{s_n} \cdot t_{off_n})}{T_{\text{cycle}}} = \frac{1}{2} \cdot \frac{(20 \text{ kW} + 13 \text{ kW} + 20 \text{ kW} + 23 \text{ kW} + 24 \text{ kW}) \cdot 0.15 \text{ s}}{18 \text{ s}}$$

= 0.417 kW = 417 W < $P_{Dmax} < 1.5 \text{ kW}$ internal brake resistor can be used

$$T_M = P_0 \cdot C_1 = 417 \text{ W} \cdot 0.2 \text{ K/W} = \mathbf{83.4 \text{ K}}$$

Start value: $T_0 = P_0 \cdot C_1 = 417 \text{ W} \cdot 0.2 \text{ K/W} = \mathbf{83.4 \text{ K}}$

$$T_1 = T_0 + C_2 \cdot P_{s_1} \cdot t_{on_1} = 83.4 \text{ K} + 0.01605 \text{ K/Ws} \cdot 20 \text{ kW} \cdot 0.15 \text{ s} = \mathbf{131.55 \text{ K}}$$

$$T_2 = (T_1 - T_M) \cdot e^{C_3 \cdot t_{off_1}} + T_M + C_2 \cdot P_{s_2} \cdot t_{on_2}$$

$$= (131.55 \text{ K} - 83.4 \text{ K}) \cdot e^{-0.9169 \text{ s}^{-1} \cdot 1.11 \text{ s}} + 83.4 \text{ K} + 0.01605 \text{ K/Ws} \cdot 13000 \text{ W} \cdot 0.15 \text{ s} = \mathbf{132.1 \text{ K}}$$

$$T_3 = (T_2 - T_M) \cdot e^{C_3 \cdot t_{\text{off}_2}} + T_M + C_2 \cdot P_{s_3} \cdot t_{\text{on}_3}$$

$$= (132,06\text{K} - 83,4\text{K}) \cdot e^{-0,9169\text{s}^{-1} \cdot 1,79\text{s}} + 83,4\text{K} + 0,01605\text{K/Ws} \cdot 20000\text{W} \cdot 0,15\text{s} = 140.98 \text{ K}$$

$$T_4 = (T_3 - T_M) \cdot e^{C_3 \cdot t_{\text{off}_3}} + T_M + C_2 \cdot P_{s_4} \cdot t_{\text{on}_4}$$

$$= (140,92\text{K} - 83,4\text{K}) \cdot e^{-0,9169\text{s}^{-1} \cdot 6,85\text{s}} + 83,4\text{K} + 0,01605\text{K/Ws} \cdot 23000\text{W} \cdot 0,15\text{s} = 138.88 \text{ K}$$

$$T_5 = (T_4 - T_M) \cdot e^{C_3 \cdot t_{\text{off}_4}} + T_M + C_2 \cdot P_{s_5} \cdot t_{\text{on}_5}$$

$$= (138,81\text{K} - 83,4\text{K}) \cdot e^{-0,9169\text{s}^{-1} \cdot 1,85\text{s}} + 83,4\text{K} + 0,01605\text{K/Ws} \cdot 24000\text{W} \cdot 0,15\text{s} = 151.35 \text{ K}$$

$$T_6 = (T_5 - T_M) \cdot e^{C_3 \cdot t_{\text{off}_5}} + T_M = (151,29\text{K} - 83,4\text{K}) \cdot e^{-0,9169\text{s}^{-1} \cdot 5,65\text{s}} + 83,4\text{K}$$

$$= (151,29\text{K} - 83,4\text{K}) \cdot e^{-0,9169\text{s}^{-1} \cdot 5,65\text{s}} + 83,4\text{K} = 83.78 \text{ K}$$

$$\Delta T = T_6 - T_0 = 83.78 \text{ K} - 83.4 \text{ K} = 0.38 \text{ K}$$

$$P_D = 0,417 \text{ kW} < 1,5 \text{ kW} \quad \text{and}$$

$$0 \text{ K} \leq \Delta T = 0,38 \text{ K} \leq 20 \text{ K} \quad \text{and}$$

$$T_1 \text{ to } T_5 \leq 400 \text{ K}$$

⇒ The internal brake resistor can be used for this application.

3.7 Output frequency dependent continuous current derating BM4XXX

The specified rated currents of all Baumüller devices are permitted continuously. The electrical output frequency in S1 operation is permitted from 15 Hz onwards. The continuously permitted output current must be reduced complying with the following characteristic curve, if the static output frequency is lower than 15 Hz and the frequency remains between 0 and 15 Hz for more than 5 seconds.

Examples:

- Speed control operations without positioning.
- Standstill operations, if current is required to keep a torque / a force.
- At operations, if it is likely that the mechanics block, for example when starting cold extruders.

The following operations are not affected:

- Typical positioning operations.
- Operating motors, which use an operating brake at standstill.
- Operations, where the higher-level control has a standstill and block monitoring.

The use of I_{rated} is permitted, as long as the derating range is passed through quickly enough. The frequency change must be ≥ 15 Hz/s.

Derating of the motor-sided output current I of the inverter against the rated output current I_{rated} is dependent on the static output frequency f of the inverter.

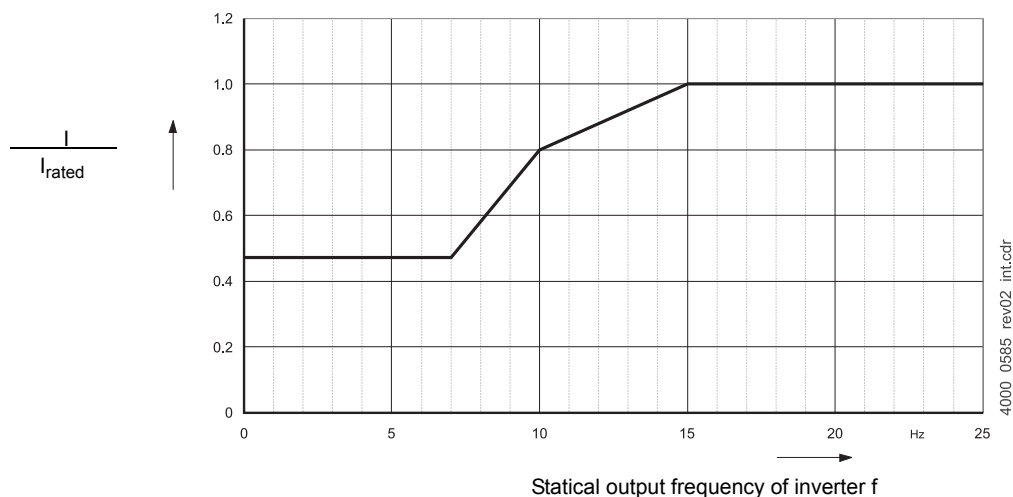

Figure 54: Continuous current derating at a static output frequency < 15 Hz

3.8 Output frequency dependent maximum current derating BM46XX

For protection of BM46XX devices (acceleration units) at output frequencies below 10 Hz the maximum current of the drive is limited and the PWM frequency is reduced by half (e. g. from 4 kHz to 2 kHz or from 8 kHz to 4 kHz).

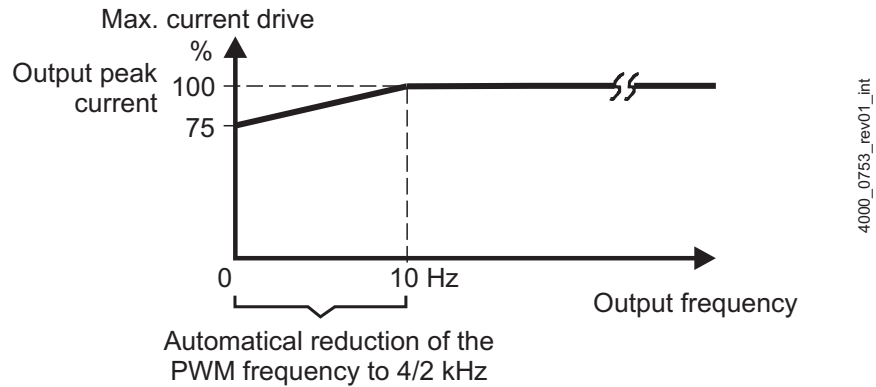

Figure 55: Reduction BM46XX max. current and PWM frequency at output frequencies < 10 Hz

The maximum current of the drive must be limited more severely at output frequencies below 10 Hz if no PWM frequency reduction is possible.

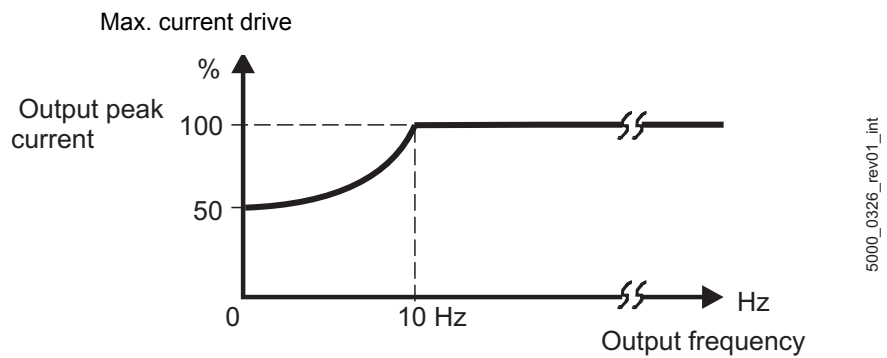

Figure 56: Reduction BM46XX only max. current at output frequencies < 10 Hz

3.9 Overload monitoring modes

Overview of devices and their associated overload monitoring modes

Standard devices		
lxt types	PT1 model	Integration model
Device identification		
Size 1 BM441X	BM4412, BM4413, BM4414	
Size 2 BM442X	BM4420, BM4421, BM4422, BM4423, BM4424, BM4425, BM4426	
Size 3 BM443X	BM4432, BM4433, BM4434, BM4435	
Size 4 BM444X	BM4442, BM4443, BM4444, BM4445	BM4446 *)
Size 5 BM445X	BM4452, BM4453, BM4454	
Size 6 BM446X	BM4462, BM4463, BM4465, BM4466	BM4464
Size 7 BM447X	BM4473	BM4472

*) Temperature model additionally to the integration model.

Special devices		
lxt types	PT1 model	Integration model
Device identification		
BM46XX		BM46XX
BM47XX	No lxt monitoring is executed	

DESIGN AND OPERATION

The devices **BM4400**, **BM4600**, **BM4700** consist of a power unit and a controller part within one housing.

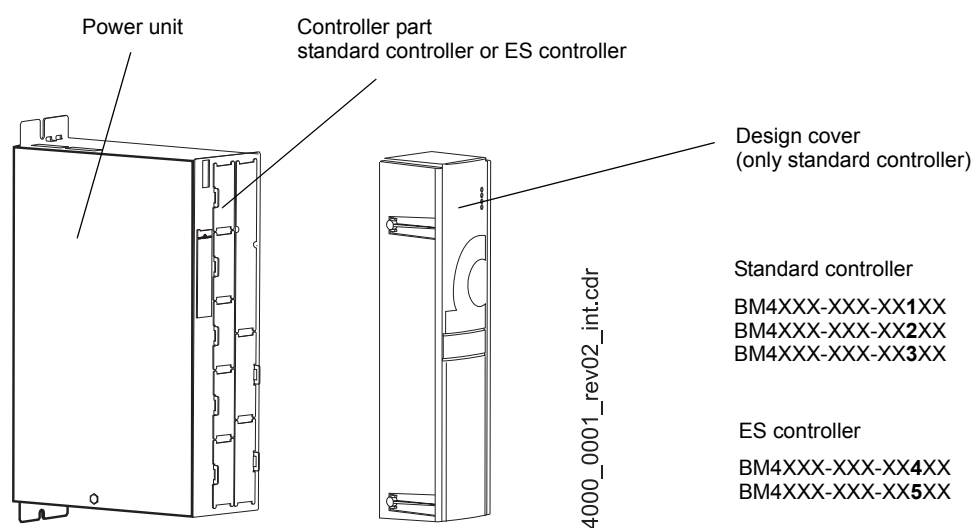

The rated current of the devices reach from 2.5 A to 720 A. The devices differ in size, power, equipment (hard- and software) and cooling types, for further information refer to [►Type code◀](#) from page 130.

4.1 Functioning

Basic unit	The present alternating voltage at the three-phase system is converted into direct voltage by the input sided rectifier. The DC link capacitors smooth this DC link direct voltage. The output sided inverter generates a three-phase system from the direct voltage with variable frequency and voltage for the supply of the connected motor. Additionally you can draw d. c. from the device via the DC link connections.
Power module	The output sided inverter generates a three-phase system via the DC link connection from the direct voltage with variable frequency and voltage for the supply of the connected motor.
BM4400	BM4400 are universal converters, for achieving electrical drives in industrial applications. BM4400 offers the largest configuration possibilities as well as the most available options.
BM4600	BM4600 (acceleration units) are especially developed servo drives derived from BM4400 for acceleration applications. Characteristic for these devices is, that the peak current is twice as large as the rated current, even at large output currents. The devices were developed for a cycle, which could provide the peak current for 1.25 s at a whole cycle duration of 5 s according to ▶Figure 30◀ on page 61. This units are not developed for peak current using at standstill or output frequencies lower than 10 Hz. For this units the ▶Output frequency dependent maximum current derating BM46XX◀ from page 117 is valid.
BM4700	BM4700 (continuous current units) are servo converters especially developed for main drives, derived from BM4400. The devices were developed to maximize the available rated current by water cooling. For this reason these devices are only available with water cooling (cooling type -F and -Z) and with none peak current (only BM5773 with low peak current).
Controller unit	The power unit is controlled by the controller unit. You can operate the controller part either with the operating software WinBASS II (up to FW 3.09) or ProDrive (from FW 3.07) or via a PLC or via a field bus and PLC.



NOTE!

Only the operation with ProDrive is described. If the software is not available, please contact Baumüller Nürnberg GmbH or visit our Website www.baumueller.com for download.

4.2 Controller

2 controller types with essential differences are available:

- Standard controller with plug-in slots to enlarge the controller functionality with function and option modules, e.g. encoder modules, analog inputs/outputs or field bus connections.
- ES controller with not exchangeable function and option modules.

**NOTE!**

Only the controller part without function/option modules is described in this Instruction handbook. A corresponding instruction handbook is available for each function/option module, refer to [►List of other applicable documents◄](#) from page 13.

4.2.1 Standard controller

Following types of the controller part are available:

Single row



4000_0467_rev01_int.cdr

This version is a 1-row equipped controller unit in a 3-row installation space.

Controller interface RS232 or Ethernet.

This controller unit is available for every 4000 except for the BM441X-XXX-X0XXX and BM441X-XXX-X1XXX.

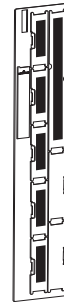

4000_0468_rev01_int.cdr

This version is a 1-row equipped controller unit in a 2-row installation space.

Controller interface RS232 or Ethernet.

This controller unit is available only in the BM441X-XXX-X0XXX.

2-rowed



4000_0010_rev01_int.cdr

This version is a 2-row equipped controller unit in a 3-row installation space.

Controller interface RS232 or Ethernet.

This controller unit is available for every BM4000 except for the BM441X-XXX-X0XXX and BM441X-XXX-X1XXX.



4000_0009_rev01_int.cdr

This version is a 2-row equipped controller unit in a 2-row installation space.

Controller interface RS232 or Ethernet.

This controller unit is available only in the BM441X-XXX-X1XXX.

3-rowed



4000_0011_rev01_int.cdr

This version is a 3-row equipped controller unit in a 3-row installation space.

Controller interface RS232 or Ethernet.

This controller unit is available for every BM4000.

In case you order a BM441X with this controller unit, you will receive the device BM441X-XXX-X2XXX.

Slots

In slots of the controller unit functional- or optional modules are plugged, which extend the functionality of the controller unit. Each slot is identified by a code letter.

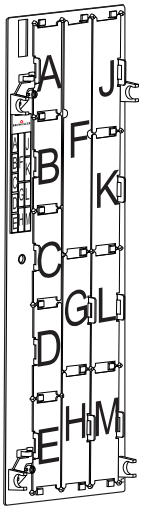

1-, 2- and 3-rowed	A	The controller communicates via a functional module bus with plug-in modules in these slots.
	B	Slot D can initiate an interrupt. Therewith slot D is particularly suitable for measuring modules.
	C	
	D	Optional modules can not be inserted into these slots.
	E	
2- and 3-rowed	F	Controller module, not exchangeable with RS232 or Ethernet interface
	G	The controller communicates via the BACI-bus with plug-in modules in these slots.
	H	Function modules can not be inserted into these slots.
3-rowed	J	The controller communicates via the BACI-bus with plug-in modules in these slots.
	K	Function modules can not be inserted into these slots.
	L	
	M	



NOTICE!

Plug-in module, which has not been manufactured from Baumüller Nürnberg GmbH. Modules of other manufacturers can damage/destroy the device.

Only use BM4-F-XXX- and BM4-O-XXX-plug-in modules.

Dependable of the existing controller unit version on your device you can retrofit optional plug-in modules (functional modules and optional modules).

Combinations function modules/option modules

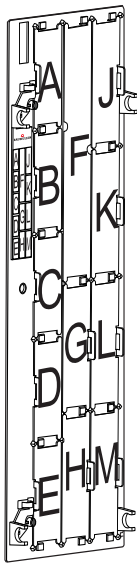

	Function modules										Option modules												
	BM4-F-ENC-XX (encoder 1 for motor control recommended)	BM4-F-ENC-XX (encoder 2)	BM4-F-AIO-01 (analog I/O)	BM4-F-AIO-02/03/04 (analog I/O)	BM4-F-DIO-XX (digital I/O)	BM4-F-FIO-XX (fast digital I/O)	BM4-F-IEE-XX (incremental encoder emulation)	BM4-F-SIE-XX (SSI encoder emulation)	BM4-F-JME-XX (mains voltage measurement)	BM4-O-SER-XX (Sercos slave)	BM4-O-PRO-01 (Profibus slave)	BM4-O-CAN-03 (CANopen slave)	BM4-O-ECT-01 (EtherCAT slave) for controller	BM4-O-PLK-01 (POWERLINK Controlled Node) für Regler	BM4-O-EIP-01 (Ethernet-IP) für Regler	BM4-O-PLC-XX (SPS)	BM4-O-CAN-04* (CANopen master)	BM4-O-IEI-XX* (incremental counter module)	BM4-O-ETH-01* (Ethernet)	BM4-O-ETH-02* (Ethernet + CANopen master)	BM4-O-ECT-01* (EtherCAT slave) for PLC	BM4-O-ECT-02* (Ethernet + EtherCAT master)	BM4-O-ECT-03* (Ethernet + EtherCAT cluster)
A	X	-	-	o	o	o	-	o	o	-	-	-	-	-	-	-	-	-	-	-	-	-	-
B	-	X	-	o	o	o	-	X	o	-	-	-	-	-	-	-	-	-	-	-	-	-	-
C	-	-	-	o	o	o	V	-	o	-	-	-	-	-	-	-	-	-	-	-	-	-	-
D	-	-	-	o	X	X	-	-	X	-	-	-	-	-	-	-	-	-	-	-	-	-	-
E	-	-	X	X	o	o	-	-	-	-	-	-	-	-	-	-	-	-	-	-	-	-	-
F	Controller unit																						
G	-	-	-	-	-	-	-	-	-	o	o	o	o	o	o	o	X	X	X	X	X	X	X
H	-	-	-	-	-	-	-	-	-	X	X	X	X	X	X	X	o	-	o	o	o	o	o
J	-	-	-	-	-	-	-	-	-	-	P	P	-	-	-	o	o	o	o	o	-	-	-
K	-	-	-	-	-	-	-	-	-	-	P	P	-	-	-	o	o	o	o	o	o	o	o
L	-	-	-	-	-	-	-	-	-	-	P	P	-	-	-	o	o	o	o	o	o	o	o
M	-	-	-	-	-	-	-	-	-	-	P	P	-	-	-	o	o	o	o	o	o	o	o

- X:** preferred slot
Baumüller Nürnberg GmbH recommends, in order to reach the highest functional range, to insert the plug-in modules into these slots.
- o:** possible slot
only if the preferred slot is occupied, we recommend in order to reach the highest functional range, to insert the plug-in modules into this slot.
- P:** only possible, if on slot G or H a PLC module (PLC) is plugged and the PLC (and not the controller) operates the communication to the field bus slave module.
- V:** dependent on controller hardware
- not possible - card doesn't work in this slot.
- * precondition for these cards is an inserted PLC module.



NOTE!

Only 2 analog outputs can be parametrized or linked even more than one AIO module is plugged.



NOTE

EtherCAT option modules **must not** be plugged in slot **J** of a 3-rowed controller unit, because the module can be damaged.

In case another BM4X-X-XXX plug-in module is plugged in an unsuitable slot, it will not operate. We have made sure, that neither the module nor the device are damaged.

4.2.2 ES controller

The controller is ordered with the desired function/option modules. The modules cannot be changed later.

Refer to [Type code](#) from page 130.

Following controller part types are available:

narrow

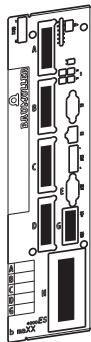

4400_0005_rev01_int.cdr

In this type up to 5 additional function/option modules can be installed.

Controller interface RS232 or Ethernet.

This controller unit is available only in the BM441X-XXX-X1XXX.

wide

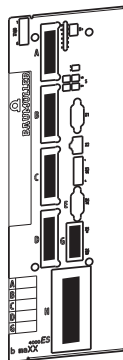

4400_0006_rev01_int.cdr

In this type up to 5 additional function/option modules can be installed.

Controller interface RS232 or Ethernet.

This controller unit is available for every BM4000.

This controller unit is available for every BM4000 except for the BM441X-XXX-X0XXX and BM441X-XXX-X1XXX.

4.2 Controller

Position of function/option modules

Function/option modules enlarge the controller functionality. All modules are permanently installed and cannot be exchanged.

Each slot is identified by a code letter

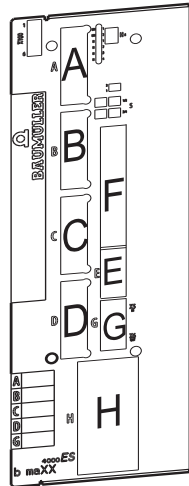

A	Function module, option
B	
C	
D	
E	Analog input/outputs BM-F-AIO-01
F	Controller unit with RS232 or Ethernet interface
G	Field bus interface, option
H	Option module, option

Combinations function/option modules

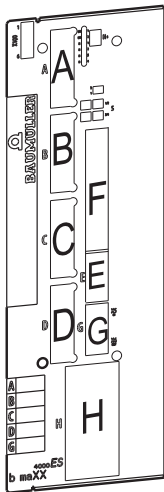

	Function modules								Option modules							
	BM4-F-ENC-XX (encoder 1) for motor control recommended	BM4-F-ENC-XX (encoder 2)	BM4-F-AIO-01 (analog I/O)	BM4-F-AIO-02/03/04 (analog I/O)	BM4-F-DIO-XX (digital I/O)	BM4-F-FIO-XX (fast digital I/O)	BM4-F-IEE-XX (incremental encoder emulation)	BM4-F-SIE-XX (SSI encoder emulation)	BM4-O-ECT-01 (EtherCAT slave) for controller	BM4-O-PLK-01 (POWERLINK Controlled Node) for controller	BM4-O-VAR-01 * (VARAN slave) for controller	BM4-O-SER-XX (Sercos slave) for controller	BM4-O-PRO-XX (Profibus slave) for controller	BM4-O-CAN-03 (CANopen slave) for controller	BM4-O-EIP-01 (Ethernet-IP) for controller	BM4-O-PLC-XX (SPS) *
A	X	-	-	o	o	o	-	o	-	-	-	-	-	-	-	-
B	-	X	-	o	o	o	-	X	-	-	-	-	-	-	-	-
C	-	-	-	o	o	o	X	-	-	-	-	-	-	-	-	-
D	-	-	-	X	X	X	-	-	-	-	-	-	-	-	-	-
E	-	-	F	-	-	-	-	-	-	-	-	-	-	-	-	-
F	Controller Unit with RS232- or Ethernet interface															
G	-	-	-	-	-	-	-	-	X	-	-	-	-	X	-	-
H	-	-	-	-	-	-	-	-	-	X	X	X	X	-	X	X

Steckkarten_ES_Rev01_e

- X:** preferred slot
- F:** permanently installed
- o:** possible slot, only the preferred slot is occupied
- :** not possible
- *:** in preparation

**NOTE!**

Only 2 analog outputs can be parametrized or linked even more than one AIO module is available.

4.2.3 Encoder modules slot/position A and B

There can be different encoder modules in slot/position A and B, refer to also [►Type code◄](#) from page 130.

Here is a choice of encoders, which you can connect to the encoder modules:

Identification	Encoder module	Encoder type	Connectable encoders examples	
BM4-F-ENC-01	Resolver module	Resolver, transmission ratio: 0.5		
BM4-F-ENC-11	Resolver reduced level	Resolver, transmission ratio: 0.28		
BM4-F-ENC-21	Resolver module replaces BM4-F-ENC-01	Resolver, transmission ratio: 0.5		
BM4-F-ENC-02	Sine-cosine encoder module with Hiperface® interface	Sine-cosine encoder singleturn	Stegmann SCS60/70	Stegmann SRS50/60
		Sine-cosine encoder multiturn	Stegmann SCM50/60	Stegmann SRM50/60
BM4-F-ENC-12	Sine-cosine encoder module with Hiperface® interface without termination in communication	Sine-cosine encoder singleturn	Stegmann SCS60/70	Stegmann SRS50/60
		Sine-cosine encoder multiturn	Stegmann SCM50/60	Stegmann SRM50/60
BM4-F-ENC-03	5V-square wave incremental encoder module	5 V-square wave incremental encoder, RS422 output signals (TTL)	Heidenhain ROD 426	SickStegmann DRS60
BM4-F-ENC-04	Sine-cosine incremental encoder module with zero-point sensing	5 V sine-cosine encoder, output signals ~1Vss	Heidenhain ROD 486	Hengstler RIS 58
BM4-F-ENC-05	Sine-cosine encoder module with EnDat® 2.1 interface	Sine-cosine encoder singleturn Sine-cosine encoder multiturn Length measurement systems	Heidenhain ECN 413 EQN 425 LC 481	Heidenhain ECN 113 EQN 1325 LC 181
BM4-F-ENC-06	Encoder module with EnDat® 2.2 interface	Encoder for absolute position sensing with SSI interface	Heidenhain ECN 1325 singleturn	Heidenhain EQN 1337 multiturn
BM4-F-ENC-07	Sine-cosine encoder module with SSI interface	Sine-cosine encoder, output signals ~1Vss, external encoder supply	SIKO AEA111	

4.3 Interconnect devices

Identification	Encoder module	Encoder type	Connectable encoders examples	
BM4-F-ENC-17	Sine-cosine encoder module with SSI interface and 5 V power supply	5 V-sine-cosine encoder, output signals ~1Vss	Baumer-Hübner MHGA400	
BM4-F-ENC-27	Encoder module with SSI interface and 5 V power supply	SSI encoder with digital output signals and 24 V supply	MTS-Sensors Temposonics	
BM4-F-ENC-08	Sine-cosine encoder module with commutation and zero-point sensing	5 V-sine-cosine encoder, incremental signals ~1Vss, commutation signals ~1 Vss	Heidenhain ERN1185	Heidenhain ERN1387

4.3 Interconnect devices

The device is part of the Baumüller series **b maXX BM4400, BM4600, BM4700** and can be connected together with other Baumüller devices.

Because of the many possible combinations and of the many applications that can be operated by **b maXX BM4400, BM4600, BM4700**, we have refrained from drawing up a guide for the interconnection of the devices in written form. Please contact the for you responsible sales department or the for you responsible employees of the application department, to discuss your concrete questions on the requirements to develop together a solution for your problem.

4.3.1 Mix mode BM443X generation 1 and 2



NOTE!

Read the version code to identify BM443X generation 1 or generation 2, refer to [►Explanation version code◄](#) on page 134.

In principle, BM443X generation 1 and 2 can be operated in mix mode.

The prerequisites are:

- A waiting time of 6 s must be observed before the drive can be enabled (pulse enable, enabling the torque)
- The total DC link capacitance of all connected devices must be lower than 20 mF.



NOTE!

When replacing a BM443X generation 1 by a generation 2 device the fuses must be adjusted as well, refer to [►Fuses BM4X3X◄](#) from page 286.

4.4 Type plate

On the type plate you will find, besides others, the type code of the device.

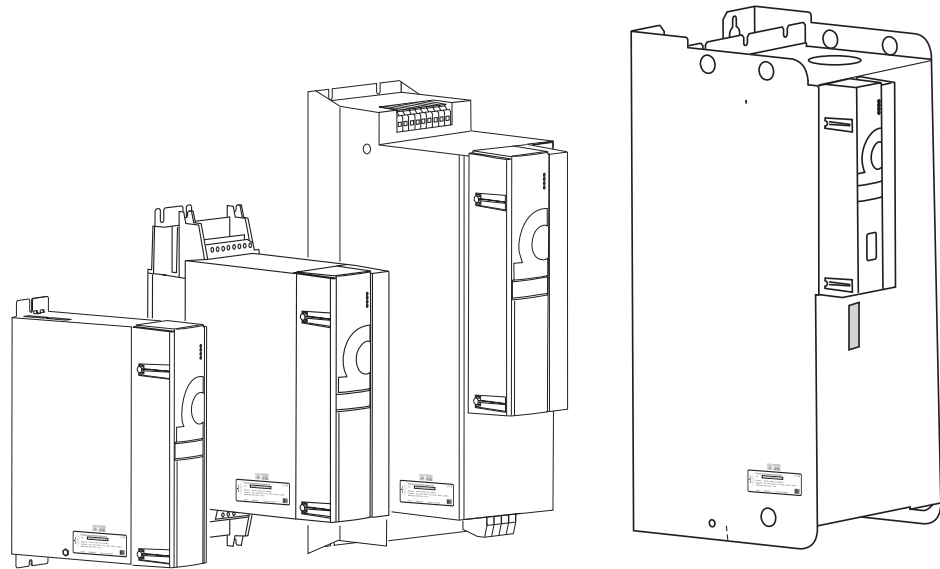

4400_0012_rev01_int.cdr



BAUMÜLLER <small>BAUMÜLLER DIFFERENTIAL CIRCUIT BREAKERS CONTACTORS www.baumuller.de MADE IN GERMANY</small>	Einbau-Einzelleistungseinheit	
	Typ: BM4453-FI-01244- S01-03	
	Eingang: 3x400V (480V) AC 50/60Hz Ausgang: 3x0...400V (460V) AC 3x150A (125A) 0..450Hz Betriebsart: GBK 130% <1min	
	Art.Nr.: 06500275 Ser.Nr.:311035532	

Figure 57: Position of type plate

4.5 Type code



NOTE!

The type code of the standard controller is only valid for the basic unit without plug-in modules. Each plug-in module has its own type code.

The type code has the form:

BM4XXX - XXX - XXXXX[Ryy] - [XXXXXXXXXX] - [XXX] - XX.

Directly behind the type code is the version code

(- XXXX - X - XXX - XXX).

4.5.1 Explanation type code

BM4XXX - XXX - XXXXX[Ryy] - [XXXXXXXXXX] - [XXX] - XX Device generation

BM4**X**XX - XXX - XXXXX[Ryy] - [XXXXXXXXXX] - [XXX] - XX Type

- 4 Vector controller with and without encoder feedback (closed loop / open loop), universal units
- 6 Vector controller like 4, acceleration unit
- 7 Vector controller like 4, continuous current unit, water-cooled

BM4**X**X - XXX - XXXXX[Ryy] - [XXXXXXXXXX] - [XXX] - XX Size of housing

1 to 7 (from housing size 1 there are two different wide versions)

BM4XX**X** - XXX - XXXXX[Ryy] - [XXXXXXXXXX] - [XXX] - XX Current grading (output rated current)

0 to 6 (current value is dependent on the size of housing)

BM4XXX - **X**XX - XXXXX[Ryy] - [XXXXXXXXXX] - [XXX] - XX Cooling type

- S air-cooled with air supply and with air outlet in the control cabinet
- A air-cooled with air supply and air outlet outside the control cabinet
- water-cooled with water cooler in the control cabinet
- Z water-cooled with water cooler outside the control cabinet
- F cooling via mounting wall of the control cabinet (cold plate)
- C

BM4XXX - **X**X - XXXXX[Ryy] - [XXXXXXXXXX] - [XXX] - XX Power supply system

- T TN or TT system
- I IT system, „Grounded delta“, TN or TT system

BM4XXX - XX**X** - XXXXX[Ryy] - [XXXXXXXXXX] - [XXX] - XX Safety relay

- 0 No module
- 1 Module with one relay and high current contacts
- 2 Module with two relays and high current contacts
- 3 Module with one relay and low current contacts
- 4 Module with two relays and low current contacts
- 5 Module with one relay and all current contacts
- 6 Module with two relays and all current contacts

BM4XXX - XXX - **X**XXXX[Ryy] - [XXXXXXXXXX] - [XXX] - XX Hardware type/power unit type

- 0 Mains inverter and active mains inverter with brake resistor transistor $U_{DC} = 540 \text{ V}$
- 1 Mains inverter and active mains inverter with brake resistor transistor $U_{\text{power supply}} = 230 \text{ V} \pm 10 \%$, $U_{DC} = 310 \text{ V}$
- 2 Power module (only output sided inverter). Operation as power module, $U_{DC} = 540 \text{ V}$
- 3 Mains inverter and active mains inverter with brake resistor transistor $U_{DC} = 540 \text{ V}$ short model for BM465X, BM466X, BM475X and BM476X
- 4 Mains inverter and active mains inverter without brake resistor transistor $U_{DC} = 540 \text{ V}$
- 5 Mains inverter and active mains inverter without brake resistor transistor $U_{DC} = 540 \text{ V}$ short model for BM465X, BM466X, BM475X and BM476X

BM4XXX - XXX - **X**XXXX[Ryy] - [XXXXXXXXXX] - [XXX] - XX Type of controller box

- 0 No modules can be plugged, 1 row
- 1 Modules in slots A to H pluggable (standard controller or ES controller), 2 rows
- 2 Modules in slots A to M pluggable (standard controller), 3 rows

BM4XXX - XXX - **XX**XX[Ryy] - [XXXXXXXXXX] - [XXX] - XX Controller hardware type

(internal information Baumüller Nürnberg GmbH)

- 0 Controller without 7 segment display (RS232 interface)
- 1 Controller without 7 segment display (RS232 interface)
- 2 Controller with 7 segment display (RS232 interface)
- 3 Controller with 7 segment display (Ethernet interface)
- 4 ES controller with 7 segment display (RS232 interface)
- 5 ES controller with 7 segment display (Ethernet interface)
- 6 „SET“ controller with 7 segment display (RS232 interface)
- 7 „SET“ controller with 7 segment display (Ethernet interface)

BM4XXX - XXX - XXX**XX**[Ryy] - [XXXXXXXXXX] - [XXX] - XX Special design

BM4XXX - XXX - XXXXX[Ryy] - [XXXXXXXXXX] - [XXX] - XX Brake resistor option

- R16 Brake resistor with 16 Ω
- R10 Brake resistor with 10 Ω
- R05 Brake resistor with 5 Ω
- R03 Brake resistor with 3 Ω

4.5 Type code

BM4XXX - XXX - XXXXX[Ryy] - [XXXXXXXX] - [XXX] - XX	ES controller field bus interface, position G
	<ul style="list-style-type: none"> 00 No field bus 10 EtherCAT for controller, SoE, standard refer to BM4-O-ECT-01 11 EtherCAT for controller, CoE, standard 12 EtherCAT for PLC, CoE 14 EtherCAT for controller, SoE, special version 16 bit ramp function generator 20 CANopen refer to BM4-O-CAN-03
BM4XXX - XXX - XXXXX[Ryy] - [XXXXXXXX] - [XXX] - XX	ES controller function module, position A
BM4XXX - XXX - XXXXX[Ryy] - [XXXXXXXX] - [XXX] - XX	ES controller function module, position B
	<ul style="list-style-type: none"> 0 No function module A Resolver refer to BM4-F-ENC-21 B SinCos Hiperface® refer to BM4-F-ENC-02 C Square wave incremental encoder refer to BM4-F-ENC-03 D SinCos with reference point detection refer to BM4-F-ENC-04 E SinCos with EnDat 2.1 refer to BM4-F-ENC-05 F Absolute value encoder EnDat 2.2 refer to BM4-F-ENC-06 G SinCos with SSi, 5 V external refer to BM4-F-ENC-07 H SinCos with reference point detection refer to BM4-F-ENC-08 I SinCos Hiperface without terminal resistance within RS485 communication refer to BM4-F-ENC-12 J Square wave incremental encoder without cable- break detection refer to BM4-F-ENC-13 K SinCos with EnDat 2.1 reference track refer to BM4-F-ENC-15 L SinCos with SSi, 5 V internal refer to BM4-F-ENC-17 M Digital IO (4 x IN, 4 x OUT) refer to BM4-F-DIO-01 N Fast digital IO (4 x IN, 4 x OUT) refer to BM4-F-FIO-01 O Analog IO (2 x IN, 2 x OUT), 16 bit refer to BM4-F-AIO-02 P Analog IO (2 x IN, 2 x OUT), 12 bit refer to BM4-F-AIO-03 Q Analog I/O (2x In-16Bit, 4-20mA / 2x Out-16Bit) BM4-F-AIO-04 R Square wave encoder emulation refer to BM4-F-IEE-01 S Square wave encoder emulation refer to BM4-F-IEE-02 T SSI encoder emulation refer to BM4-F-SIE-01 U Digital I/O without PE connection (4x IN,4x OUT) BM4-F-DIO-11 Fast digital I/O without PE connection V (4x IN,4x OUT) refer to BM4-F-FIO-11 W SSI encoder with 24 V refer to BM4-F-ENC-27
BM4XXX - XXX - XXXXX[Ryy] - [XXXXXXXX] - [XXX] - XX	ES controller function module, position C
BM4XXX - XXX - XXXXX[Ryy] - [XXXXXXXX] - [XXX] - XX	ES controller function module, position D
	<ul style="list-style-type: none"> 0 No function module M Digital IO (4 x IN, 4 x OUT) refer to BM4-F-DIO-01 N Fast digital IO (4 x IN, 4 x OUT) refer to BM4-F-FIO-01 O Analog IO (2 x IN, 2 x OUT), 16 bit refer to BM4-F-AIO-02 P Analog IO (2 x IN, 2 x OUT), 12 bit refer to BM4-F-AIO-03 Q Analog I/O (2x In-16 bit, 4-20mA / 2x Out-16 bit) BM4-F-AIO-04 R Square wave encoder emulation refer to BM4-F-IEE-01 S Square wave encoder emulation refer to BM4-F-IEE-02 T SSI encoder emulation refer to BM4-F-SIE-01 U Digital I/O without PE connection (4x IN,4x OUT) BM4-F-DIO-11 V Fast digital I/O without PE connection (4 x IN, 4 x OUT) refer to BM4-F-FIO-11

BM4XXX - XXX - XXXXX[Ryy] - [XXXXXX~~XX~~] - [XXX] - XX ES controller function module, position H

- 00 No option module
- 10 Sercos slave, standard refer to BM4-O-SER-XX
- 20 Profibus slave, standard refer to BM4-O-PRO-XX
- 30 CANopen slave, standard BM4-O-CAN-XX
- 50 PLC, standard, MC, without flash refer to BM4-O-PLC-XX
- 51 PLC, standard, MC, 4 MB flash
- 52 PLC, local, without MC, only for slave option modules, without NOVRAM, Runtime license, standard
- 53 PLC, Local, without MC, only for slave option modules, 56 kB NOVRAM, Runtime license, standard
- 54 PLC, standard, option licensing right TechLib
- 55 PLC, standard, option coated, without licensing right
- 60 EtherCAT for controller, SoE, special 16 bit RFG BM4-O-ETH-XX
- 61 EtherCAT for controller, CoE, standard
- 62 EtherCAT for controller, SoE, standard
- 80 VARAN slave refer to BM4-O-VAR-XX
- 90 POWERLINK controlled node refer to BM4-O-PLK-XX

BM4XXX - XXX - XXXXX[Ryy] - [XXXXXXXX] - [XXX] - XX Safety functionality option

- S01 Safety function STO

BM4XXX - XXX - XXXXX[Ryy] - [XXXXXXXX] - [XXX] - ~~XX~~ Software release controller (firmware)

- 01 Serial version 1.x
- 03 Serial version 3.x



NOTE!

A device with safety relay, whose part number does **not** start with „06“, does not apply as a safety device as defined by the PL classification according to ISO 13849 or SIL according to EN 61800. This device is not certificated for safety functions

Devices with the approval mark of TÜV Rheinland and the Safety label provide a certified safety function, only, refer to [►Page 31](#)◀.



Functional
Safety
Type
Approved

www.tuv.com
ID 0600000000

4.5 Type code

4.5.2 Explanation version code

The version code is added on the type code.



NOTE!

Only version codes necessary for the user are explained.

XXXX - X - XXX- XXX Design version power unit

3004 BM443X generation 1
From 3006 BM443X generation 2

XXXX - **X - XXX- XXX** Design version controller

4.6 UL notes

The notes below must be observed at a $c\text{UL}$ - conformity drive.

In case you consider UL 508 C observe the notes below also:

- [▶Parameter manual b maXX 4400, 4600, 4700◀](#)
 - Adjustment for motor overload monitoring (I^2t)
- [▶Requirements to the connecting cables◀](#) on page 172
 - Use 60 °C/75 °C copper wire only for all devices
 - Use Class 1 wire only.
- [▶Electrical connection power unit◀](#) on page 198
 - Note tightening torque for connection terminals.
- Only for water-cooled devices:
 - In order to avoid internal condensation: The temperature of cooling water supply must be higher or at least equal to the internal temperature of the device.
 - Maximum cooling water temperature 60°C
 - Maximum water pressure 3 bar / 300 kPa in the cooling circuit.
- [▶Required environmental conditions◀](#) on page 57
 - Use the device only in a pollution degree 2 environment
 - Observe the maximum environmental temperature and the derating
- [▶Requirements to the energy supply / supply system◀](#) on page 54
 - Observe the short circuit current capability.
The device is rated for a maximum Short Circuit Current Rating (SCCR) of 65 kA, 480 V AC.
 - 24 V supply must not reach more than 30 V DC. Additional fuse protection with max. 4 A fuse.
- [▶Fuses◀](#) from page 279
 - Converters may be used with listed fuses or listed circuit breakers DIVQ as overcurrent protection.
- [▶Requirements for the motor temperature sensors◀](#) from page 177
 - Observe the connecting data of the motor temperature sensor.

cUL notes

Additional only for Canada:



NOTE

Overvoltage Protection Device have to be installed in front of the input circuit of the device to limit the maximum overvoltage peak to 2.5 kV.

4.7 Display and operation elements

4.7.1 LEDs

- **Standard controller 4 LEDs without 7-segment display**
BM4XXX - XXX - XX0XX and BM4XXX - XXX - XX1XX:
On the front side of the device there are 4 LEDs. The 4 LEDs (H1 to H4) show information about the operating status and are also displayed in the operating software.
- **Standard controller 6 LEDs with 7-segment display**
On the front side of the device there are 6 LEDs. Both upper LEDs (UH1 and UH2) are reserved. The four lower LEDs (H1 to H4) show information about the operating status and are also displayed in the operating software.
[▶Standard controller◀](#) on page 203 shows the position of the display elements.
- **ES controller**
BM4XXX - XXX - XX4XX and BM4XXX - XXX - XX5XX:
On the front side of the device there are 6 LEDs. Both upper LEDs (UH1 and UH2) are reserved. The four lower LEDs (H1 to H4) show information about the operating status and are also displayed in the operating software.
[▶ES controller◀](#) on page 204 shows the position of the display elements.

LED (UH1, UH2)

Both LEDs UH1 and UH2 are not led through to the design cover.

Not available with BM4XXX - XXX - XX0XX and BM4XXX - XXX - XX1XX.

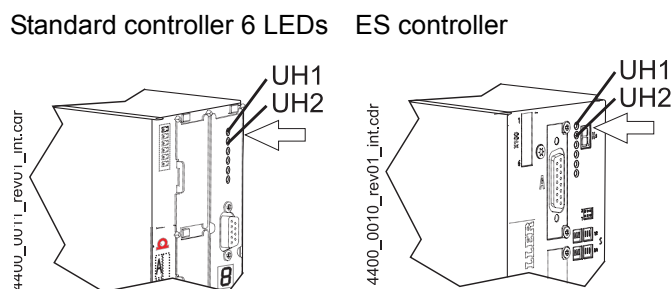

Operating status Both of the upper LEDs (H1 and H2) indicate the drive status.

H1

Design cover
standard controller 4 LEDs

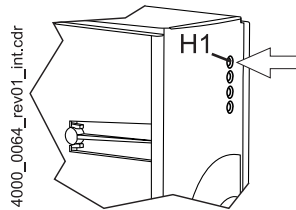

Without design cover
standard controller 6 LEDs

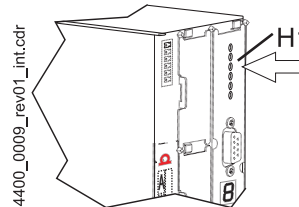

ES controller

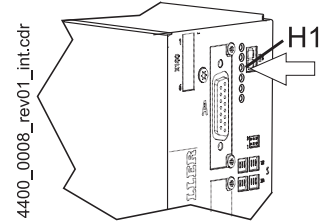

green: the motor rotates, torque direction 1.
orange: the motor rotates, torque direction 2.



NOTE!

LED H1 shows only the torque direction, it cannot be used to show the direction of rotation.

H2

green: Pulse enable.
The motor is supplied by the power unit

orange: Power ON, the device is ready-to-operate.
In case the LED lights up orange colored during operation, maybe the pulse enable is missing or the quickstop was activated.

flashing green/orange: Pulses enabled for generating the magnetic field of asynchronous machines. No torque enable yet.

green with short orange flashing memory access EEPROM, if possible do not switch off or the device in this phase.

orange with short green flashing:

Current limit H3

red: set current limit of the controlled has been reached.

- adapt your threshold or set „no reaction“

Error H4

LED doesn't light up: the internal monitoring have not found an error.

red, continuously: Error.

- Identify and then remove the error with help of the operating program ProDrive or the 7-segment display. For further information refer to [▶Troubleshooting and Fault Correction](#) from page 235.

red, flashing: Warning

- Identify the warning with help of the operating program ProDrive. Warning messages do not affect the operation of the device. For further information refer to [▶Troubleshooting and Fault Correction](#) from page 235

4.7.2 7-segment display

The 7-segment-display in normal operation shows the operation status.
 In case of error the error code is shown.
 (not BM4XXX - XXX - XX0XX and BM4XXX - XXX - XX1XX)

Display	Status	Meaning
0	Not ready to start	Initialization phase, pulses inhibited
1	Inhibit start	Pulses inhibited, initialization completed error-free
2	Ready-to-start	Pulses inhibited
3	Switched on	Pulses for field generation at asynchronous machines enabled, no torque generation yet.
4	Operation enabled	Pulses enabled, drive function enabled
5	Inhibit operation active	Pulses enabled, braking procedure active
6	Shutdown active	Pulses enabled, braking procedure active
7	Quick stop active	Pulses enabled, braking procedure active
E	Error reaction active	Pulses enabled, braking procedure active
F	Fault	Pulses inhibited, error status The display shows the error code.

The single drive statuses are specified in chapter device management in parameter manual 5.03039.

The display shows the error code in error status. Only errors are displayed, which enable an error reaction or have enabled one. Errors without reaction and warnings are not displayed (refer to [▶Fault detection◀](#) from page 240).

4.7.3 Address switch S1 - S4 (only ES controller)

EtherCAT® Type code ES controller with EtherCAT®:
 BM4XXX - XXX - XXXXX[Ryy] - 1X (with EtherCAT® interface)

IP address S1 to S4 The IP address of the controller consists of 32 bits or 4 bytes (e.g. 192.168.125.203). Both of the first bytes are set with the base address (192.168.) at the factory. Both of the last bytes are set by means of the address switches S1, S2, S3 and S4. In the process, S1 and S2 as well as S3 and S4 each represent an 8 bit value.

The IP address 192.168.0.0 is not permitted or, respectively, is reserved.

For information on changing the base address, refer to the parameter manual.

Example

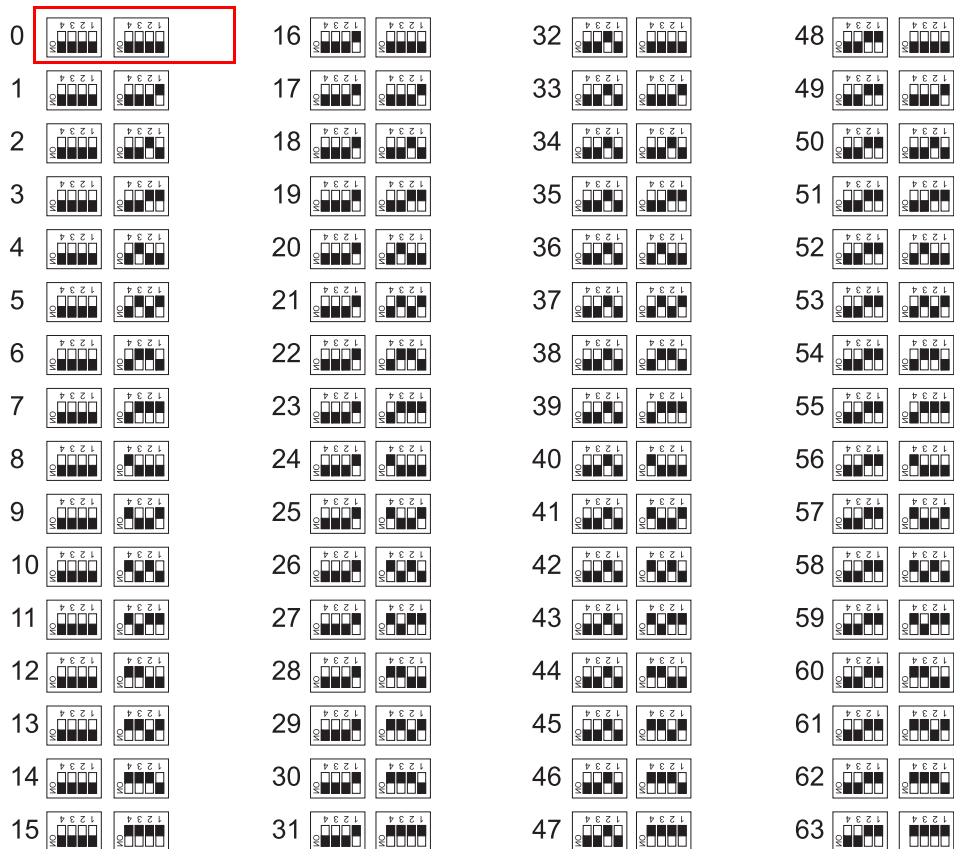
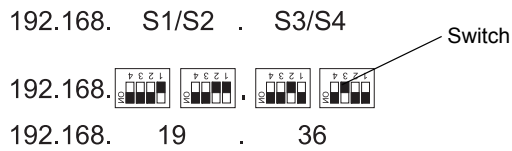

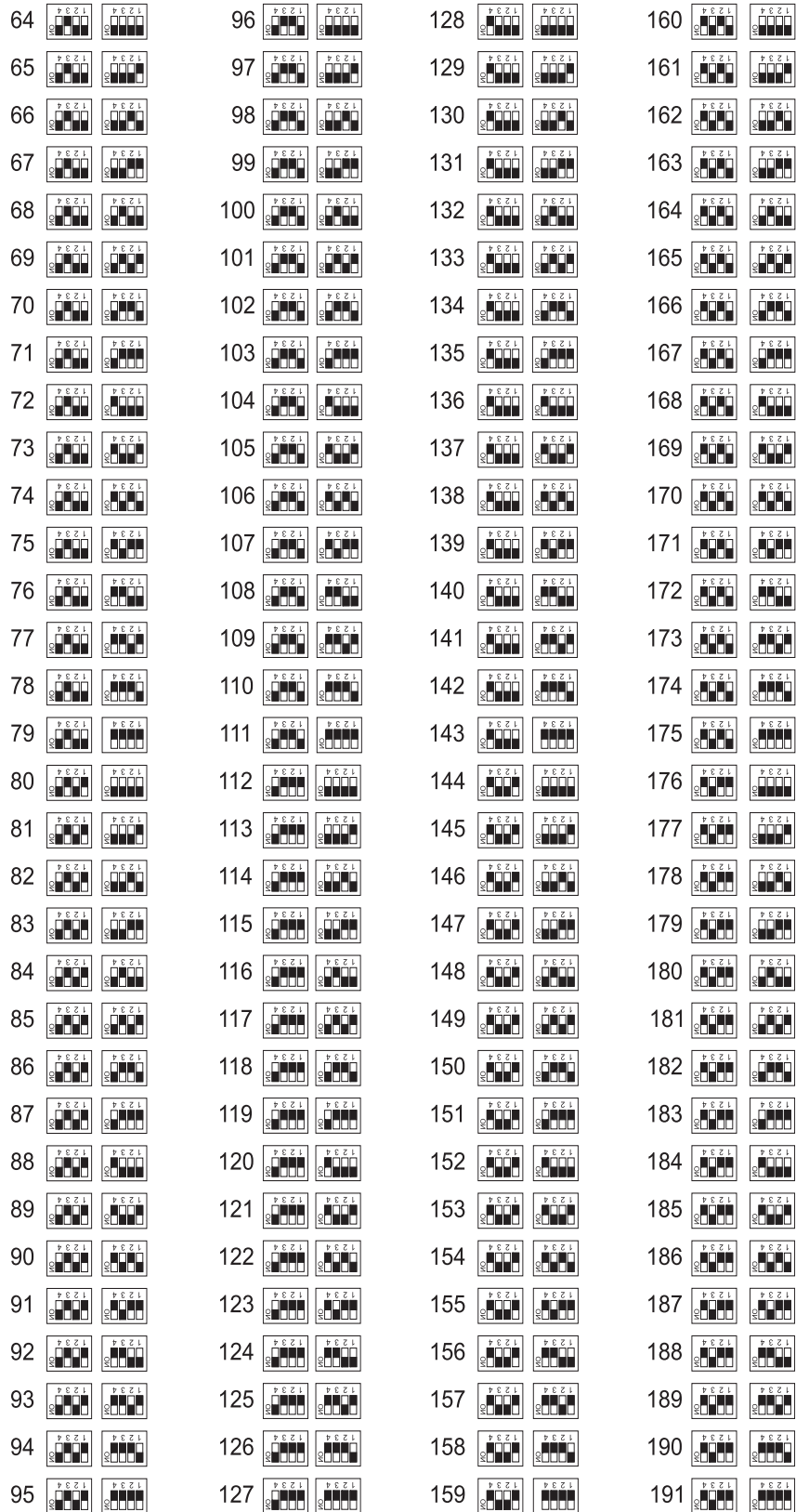

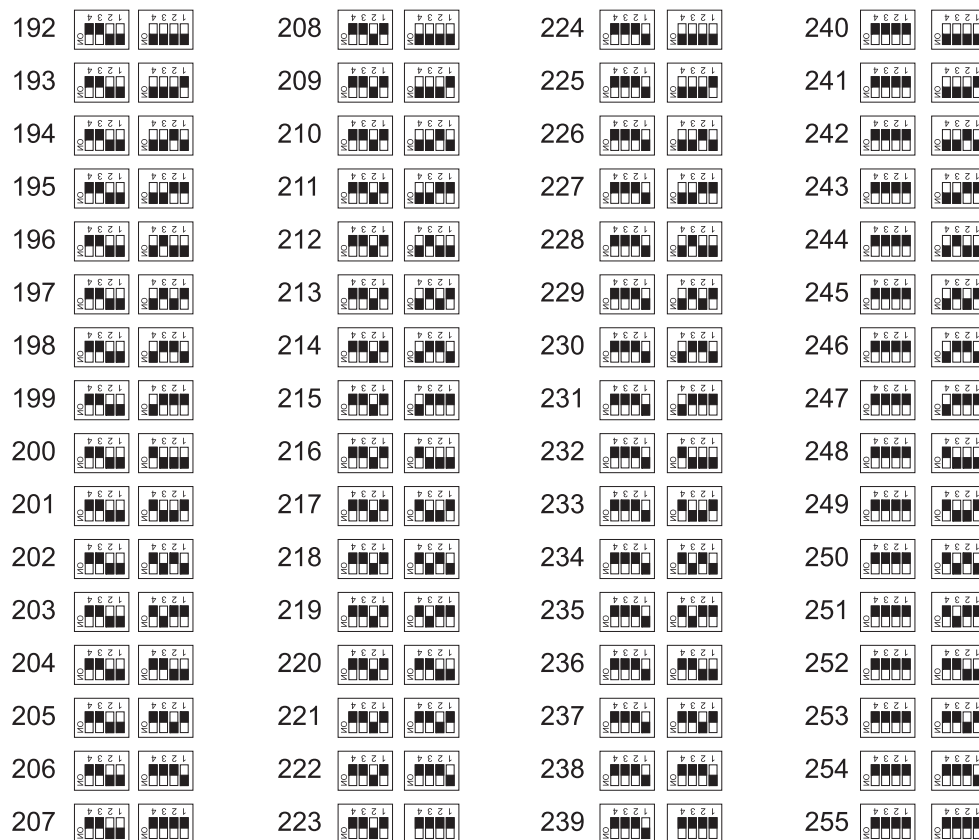

Figure 58: EtherCAT® Address switch setting

CANopen®

Type code ES controller with CANopen®:

BM4XXX - XXX - XXXXX[Ryy] - 2X (with CANopen interface)

Baud rate S2

20 kBit/s

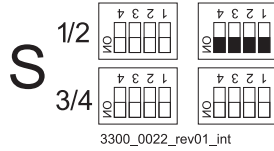

125 kBit/s

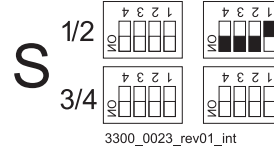

250 kBit/s

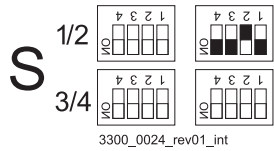

500 kBit/s

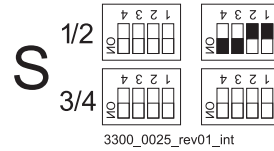

1 MBit/s

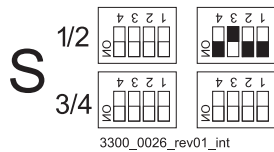

Address S3/S4

S3/S4	ID	S3/S4	ID	S3/S4	ID	S3/S4	ID
	0		32		64		96
	1		33		65		97
	2		34		66		98
	3		35		67		99
	4		36		68		100
	5		37		69		101
	6		38		70		102
	7		39		71		103
	8		40		72		104
	9		41		73		105
	10		42		74		106
	11		43		75		107
	12		44		76		108
	13		45		77		109
	14		46		78		110
	15		47		79		111
	16		48		80		112
	17		49		81		113
	18		50		82		114
	19		51		83		115
	20		52		84		116
	21		53		85		117
	22		54		86		118
	23		55		87		119
	24		56		88		120
	25		57		89		121
	26		58		90		122
	27		59		91		123
	28		60		92		124
	29		61		93		125
	30		62		94		126
	31		63		95		127

Figure 59: CANopen® address switch

TRANSPORT AND PACKAGING

5.1 Safety notes for transport

**NOTICE!****Damage due to unauthorized transport!**

Transport handled by untrained personnel can lead to a substantial amount of material damage.

Therefore:

- The unloading of the packages upon delivery as well as the in-house transport should only be done by trained personnel.
- Contact Baumüller Nürnberg GmbH sales office if necessary.

**WARNING!****Danger of mechanical hazard!**

Secure devices against falling down.

Therefore:

- Take suitable measures, such as supports, hoists, straps, etc., to ensure that devices cannot fall down.
- Use appropriate handling material.

5.2 What to observe when transporting

For initial transport of the device, it is packed at the manufacturer. If the device is to be further transported, ensure that the following conditions are met throughout the entire transport:

- Climate class 2 K 3 as per EN 60721-3-2
- Temperature range - 25 °C up to + 70 °C
- Vibration, shock, continuous shock class 2 M 1 as in EN 60721-3-2

5.3 Transport inspection

Upon receiving the delivered goods, immediately examine them for completeness and transport damage.

If there is outwardly visible transport damage, proceed as follows:

- Do not accept the delivery or conditionally accept it with reservations.
- Note the extent of the damage on the transport documents or on the delivery note of the transport agent.
- Immediately file a complaint with the freight carrier. Have the complaint confirmed in writing and immediately contact the responsible representative of Baumüller Nürnberg GmbH.



NOTE!

The device may not be operated if there is visible transport damage!

5.4 Unpacking

After having received the still packaged device:

- Avoid transport shocks and hard jolts, e.g. when putting an item down.

If no transport damage is visible:

- Open the packaging of the device.
- Verify the delivery scope based on the delivery note.

File a claim with the responsible Baumüller representative if the delivery is incomplete.



NOTE!

Claim each individual deficiency as soon as it has been detected. Damage claims can only be validly asserted within the claim registration period.

5.5 Disposal of the packaging

The packaging consists of cardboard, plastic, metal parts, corrugated cardboard and/or wood.

- When disposing of the packaging, comply with the national regulations.

6

MOUNTING

The device is designed for mounting in a control cabinet.

Mounting consists of the following steps:

- 1 Prepare mounting
(for drill holes/cut-out segments, refer to [▶Drilling patterns◀](#) from page 151)
- 2 Install
(fixing refer to [▶Mounting instructions◀](#) on page 159)

6.1 Safety notes



NOTE!

Mounting shall only be performed by employees of the manufacturer or by other qualified personnel.

Qualified personnel are persons who – on account of their occupational training, experience, instruction and knowledge of relevant standards and stipulations, accident prevention regulations and operating conditions – are authorized by the persons responsible for the safety of the facilities to perform the respective activities that are necessary, while at the same time recognizing and preventing any potential risks. The qualifications necessary for working with the device are, for example:

- Occupational training or instruction in accordance with the standards of safety engineering for the care and use of appropriate safety equipment.



WARNING!

Danger as a result of faulty mounting!

The mounting requires qualified personnel with adequate experience. Faulty mounting can lead to life-threatening situations or substantial material damage.

Therefore:

- Only allow mounting to be performed by employees of the manufacturer or by other qualified personnel.



WARNING!

Danger of mechanical impact!

Secure devices against falling down.

Therefore:

- Take suitable measures, such as supports, hoists and assisting personnel, to ensure that device cannot fall down.
- Use appropriate means of transport.



NOTICE!

Danger due to electrostatic discharge.

The connecting terminals of the device are partially at risk due from ESD.

Therefore:

Please heed the respective notes.



CAUTION!

Danger due to sharp edges.

If the device is lifted with unprotected hands during mounting, palms or fingers can be cut. If the device falls, feet could be injured.

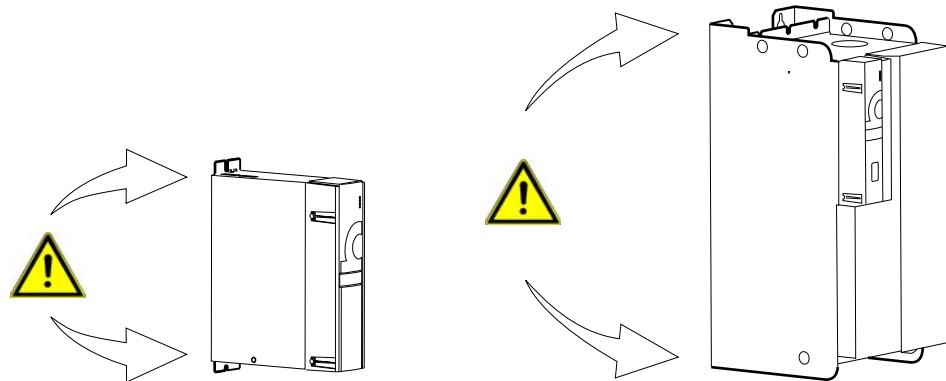

Figure 60: Danger area near the mechanical mounting

Therefore:

- Ensure that only qualified personnel, who are familiar with the safety notes and assembly instructions, mount this device.



Wear safety gloves.



Wear safety shoes.

6.2 Preparing for mounting

Based on the planning documents and the drilling pattern (refer to [▶Drilling patterns◀](#) from page 151), the cutout sections and the positions of the attachment drill holes can be determined.



NOTICE!

Property damage due to conductive contamination.

Therefore:

- When performing installation work of any kind, it must be ensured that no foreign material (e.g. drill shavings, copper strands, etc.) gets into the device as a result.
- If possible, the drilling of the holes should be done before mounting the device and the configuring of the cables should take place outside of the control cabinet. If this is not possible, the device must be appropriately covered. Remove this covering again prior to start!



CAUTION!

Eye injury due to flung particles.

Metal particles are flung when making the drill holes and the cutout sections.

Therefore:



Wear protective eye wear!

- ▶ Preparing drill holes and cutout sections.

6.2.1 Drilling patterns

Use the drilling pattern to make the necessary drill holes/cutout sections.



NOTE!

Consider the minimum clearances for cooling when making the drill holes.

All dimensions in millimeters [mm].

Further notes refer to [►Dimensions◄](#) from page 33 and [►Cooling◄](#) from page 63.

How to determine the required space in the control cabinet, refer to [►Dimensions◄](#) from page 33.

Tolerance specifications

Drill hole dimensioning	±0.2 mm
Dimensioning openings	+1.0 mm
Relative tolerance of discretionary divisions	±0.1 mm

6.2.1.1 Drilling patterns BM441X

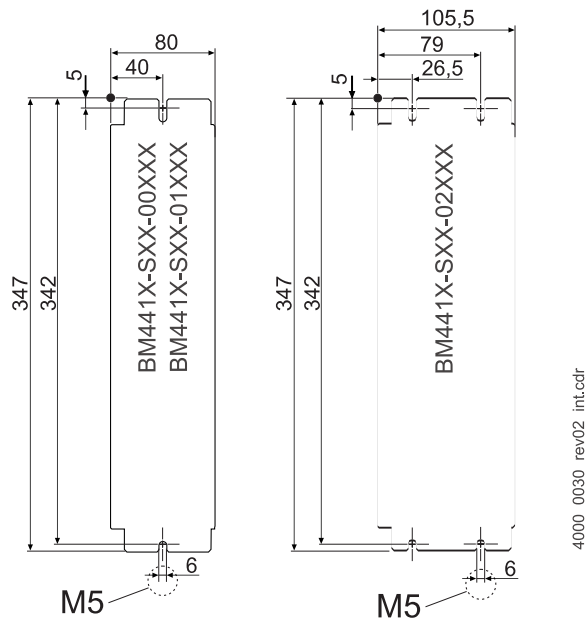

Figure 61: Drilling pattern BM441X

6.2 Preparing for mounting

6.2.1.2 Drilling patterns BM442X

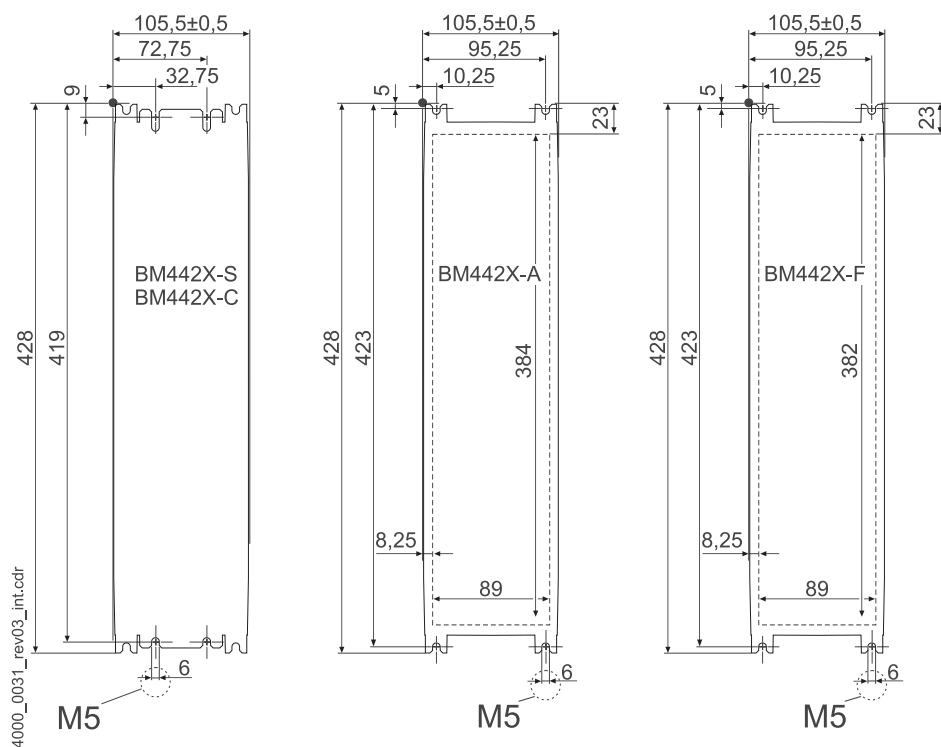

Figure 62: Drilling pattern BM442X

6.2.1.3 Drilling patterns BM4X3X

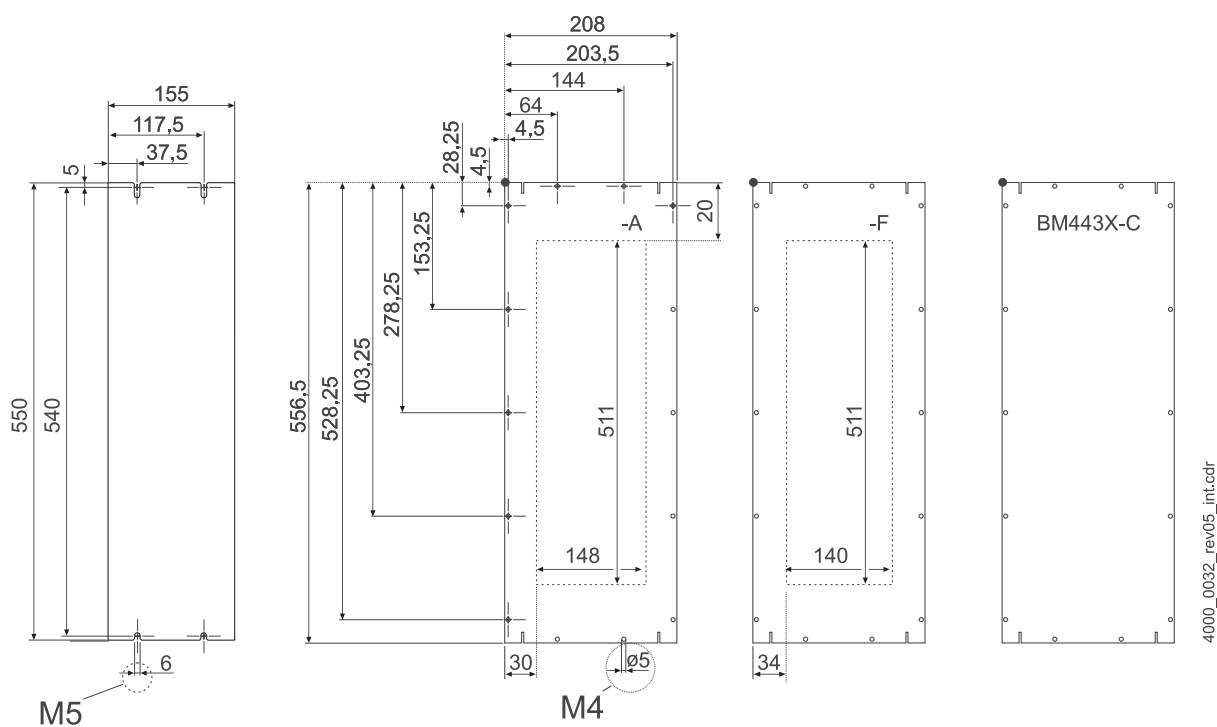

Figure 63: Drilling pattern BM443X, BM463X

6.2.1.4 Drilling patterns BM4X4X

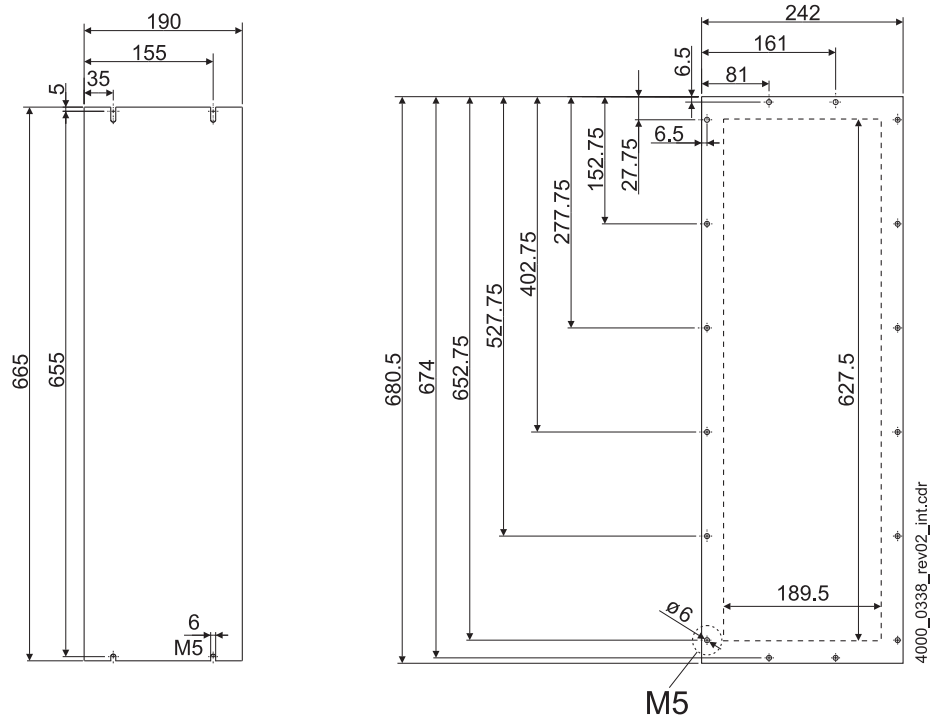

Figure 64: Drilling pattern BM444X, BM464X

6.2 Preparing for mounting

6.2.1.5 Drilling patterns BM4X5X

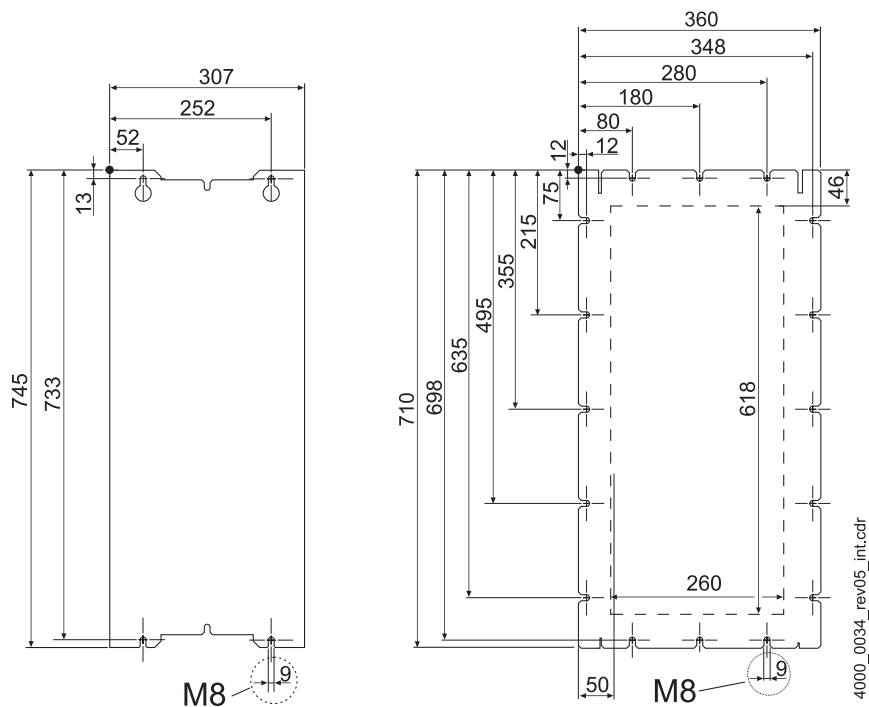

Figure 65: Drilling pattern BM445X, BM465X

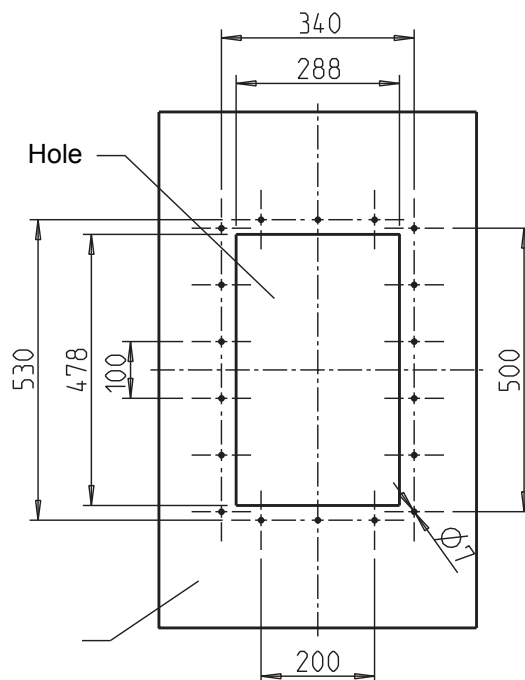

Figure 66: Drilling pattern BM465X-FXX-3XXXX, BM475X-FXX-3XXXX

6.2.1.6 Drilling patterns BM4X6X

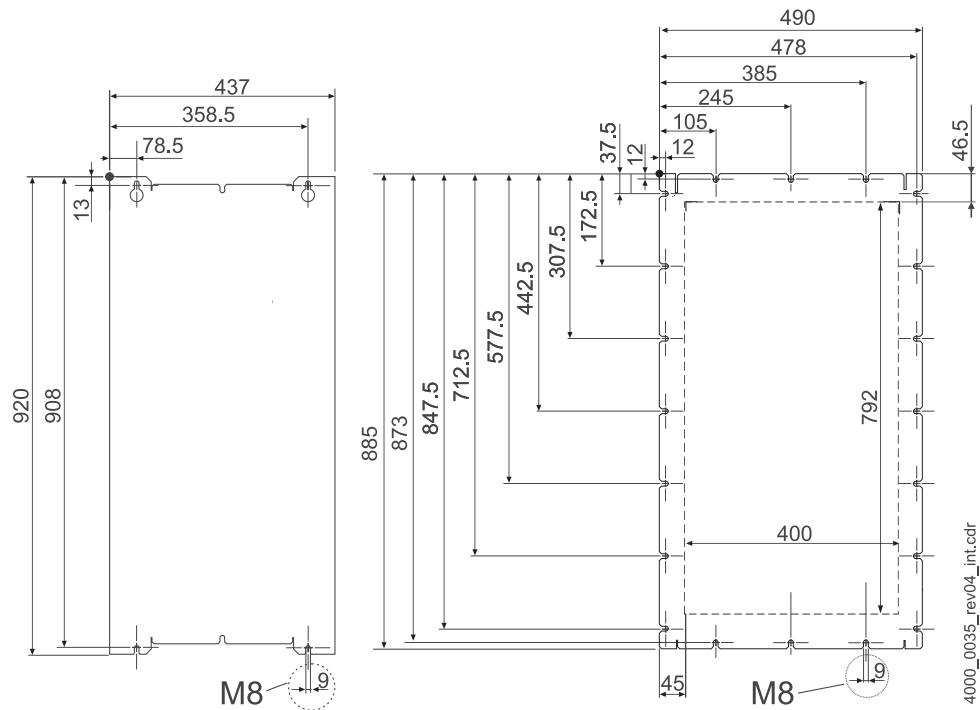

Figure 67: Drilling pattern BM446X, BM466X

6.2 Preparing for mounting

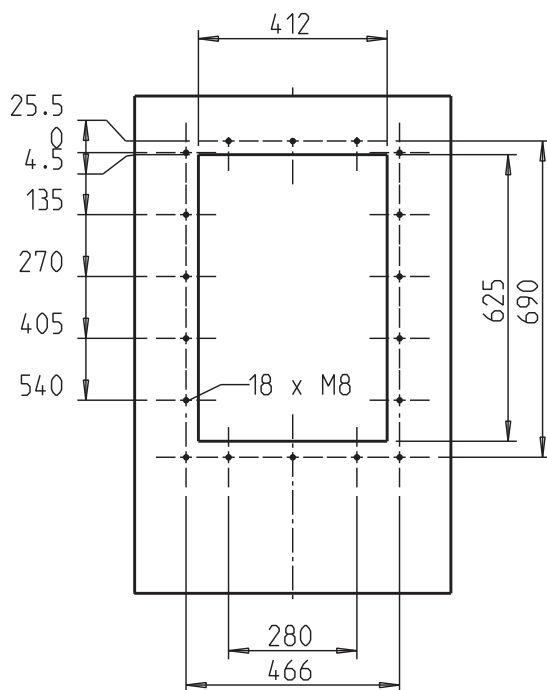

Figure 68: Drilling pattern BM466X-FXX-3XXXX, BM4766-FXX-3XXXX

6.2.1.7 Drilling patterns BM4X7X

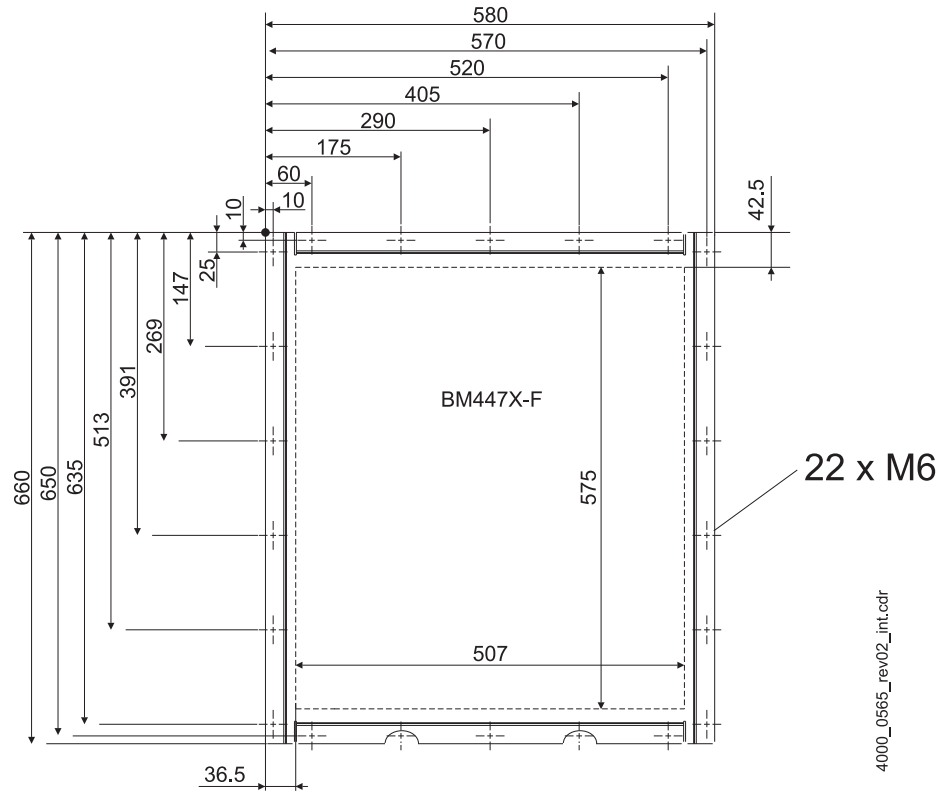

Figure 69: Drilling pattern BM447X-F, BM477X-F

6.2 Preparing for mounting

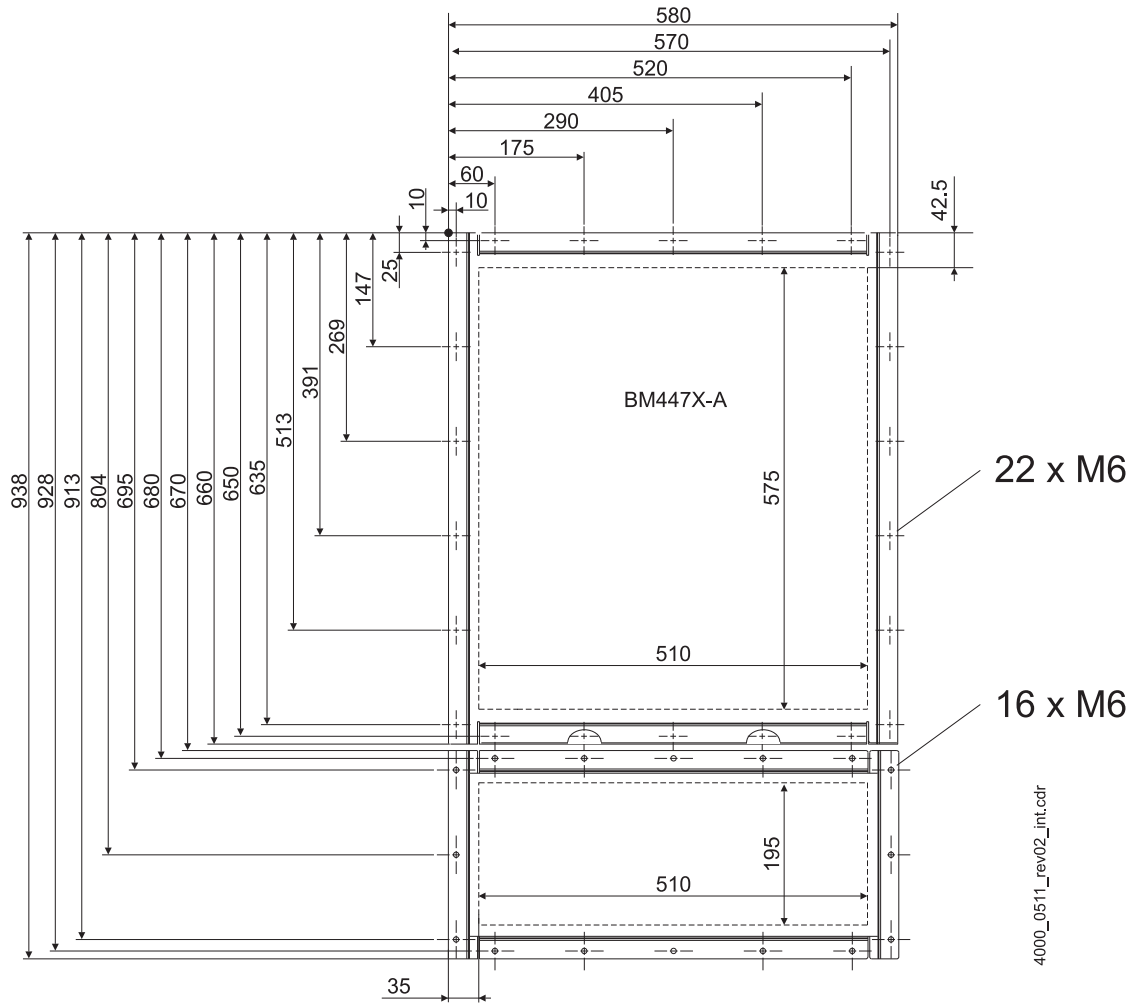

Figure 70: Drilling pattern BM447X-A

4000_0511_rev02_int.cdr

6.3 Mounting instructions

There are different kinds of mounting.

Each mounting method is shown in a graphic (refer to [▶Figure 71◀](#) on page 160 to [▶Figure 74◀](#) on page 163)

The screws and washers required for mounting are listed beneath the respective graphic.

Carry out mounting as follows:

- 1 Provide suitable transport/lifting equipment as needed.
- 2 Keep suitable fastening components readily available.
- 3 For cold plate devices:
 - check the surface quality of device's rear panel/mounting plate, refer to [▶Requirements mounting plate for cold plate◀](#) on page 166
- 4 Mount the device.
- 5 Subsequently connect the water-cooling unit

6.3 Mounting instructions

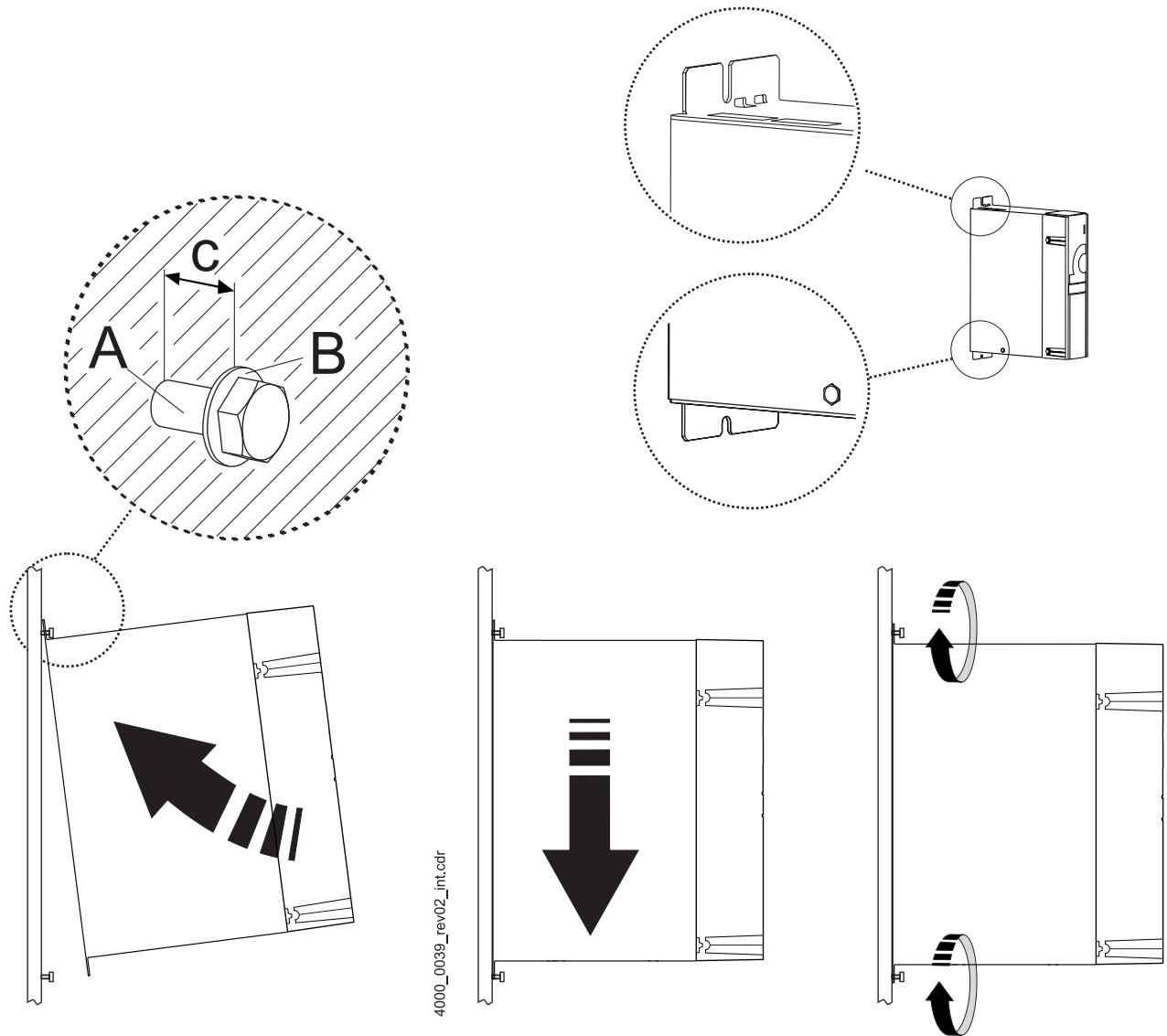
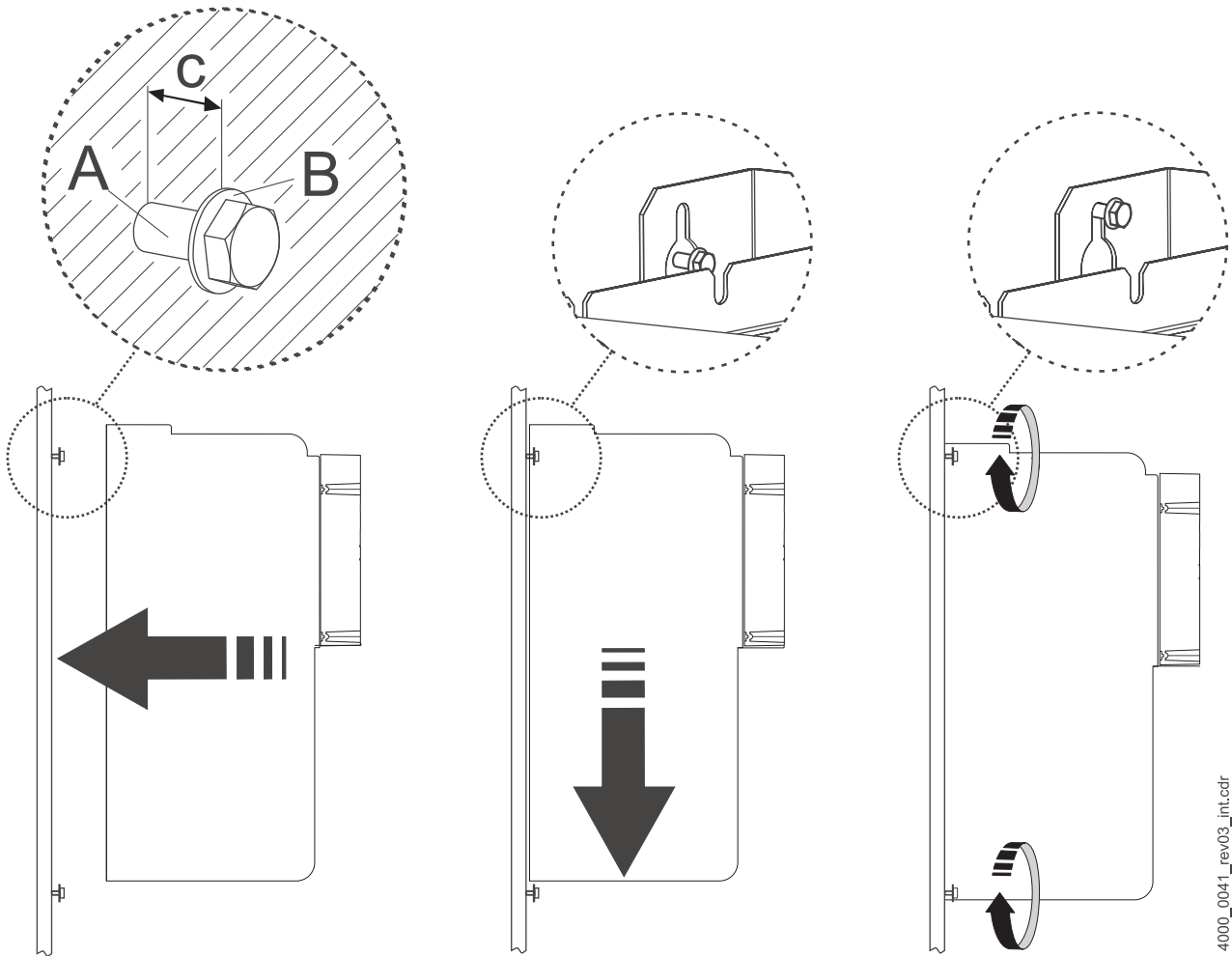

Figure 71: Mounting instruction BM441X, BM442X-S, BM4X3X-S/Z, BM444X-S/Z, BM464X-S/Z

Device	BM441X-XXX -X0 -X1	BM441X-XXX -X2	BM442X-S	BM443X-S/Z BM463X-Z	BM444X-S/Z BM464X-Z
A - Screws	2 x M5	4 x M5	4 x M5	4 x M5	4 x M5
B - Washers	2 x (5.3 x 10)	4 x (5.3 x 10)	4 x (5.3 x 10)	4 x (5.3 x 10)	4 x (5.3x15)
c - Mounting space	c = 5 mm	c = 5 mm	c = 5 mm	c = 5 mm	c = 5 mm



4000_0041_rev03_int.cdr

Figure 72: Mounting instruction BM445X-S/Z, BM465X-S/Z, BM446X-S/Z, BM466X-S/Z

Device	BM445X-S/Z BM465X-Z	BM446X-S/Z BM466X-Z
A - Screws	4x M8	4x M8
B - Washers	4x (8.4x21)	4x (8.4x21)
C - Mounting space	c=7 mm	c=7 mm

6.3 Mounting instructions

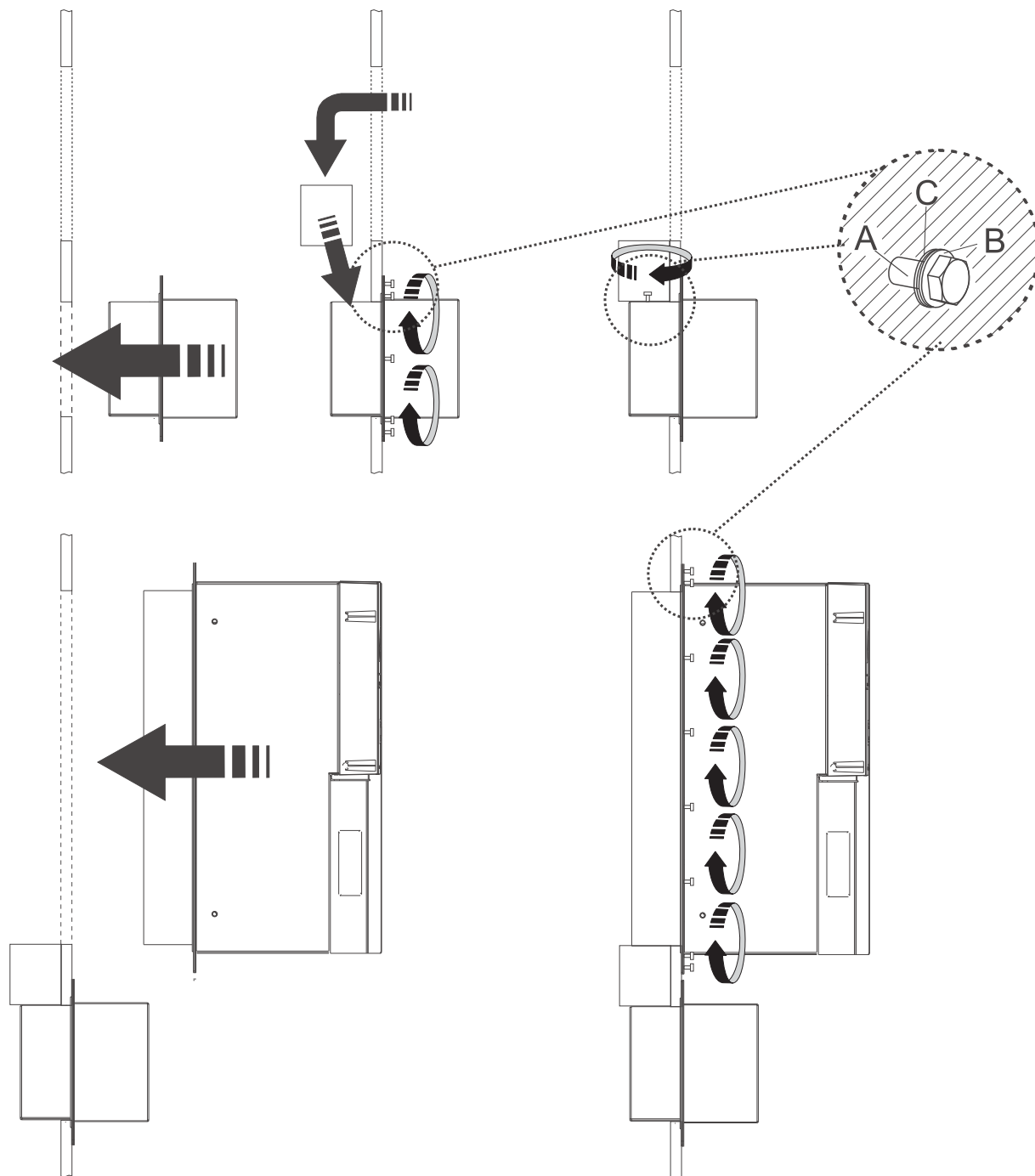
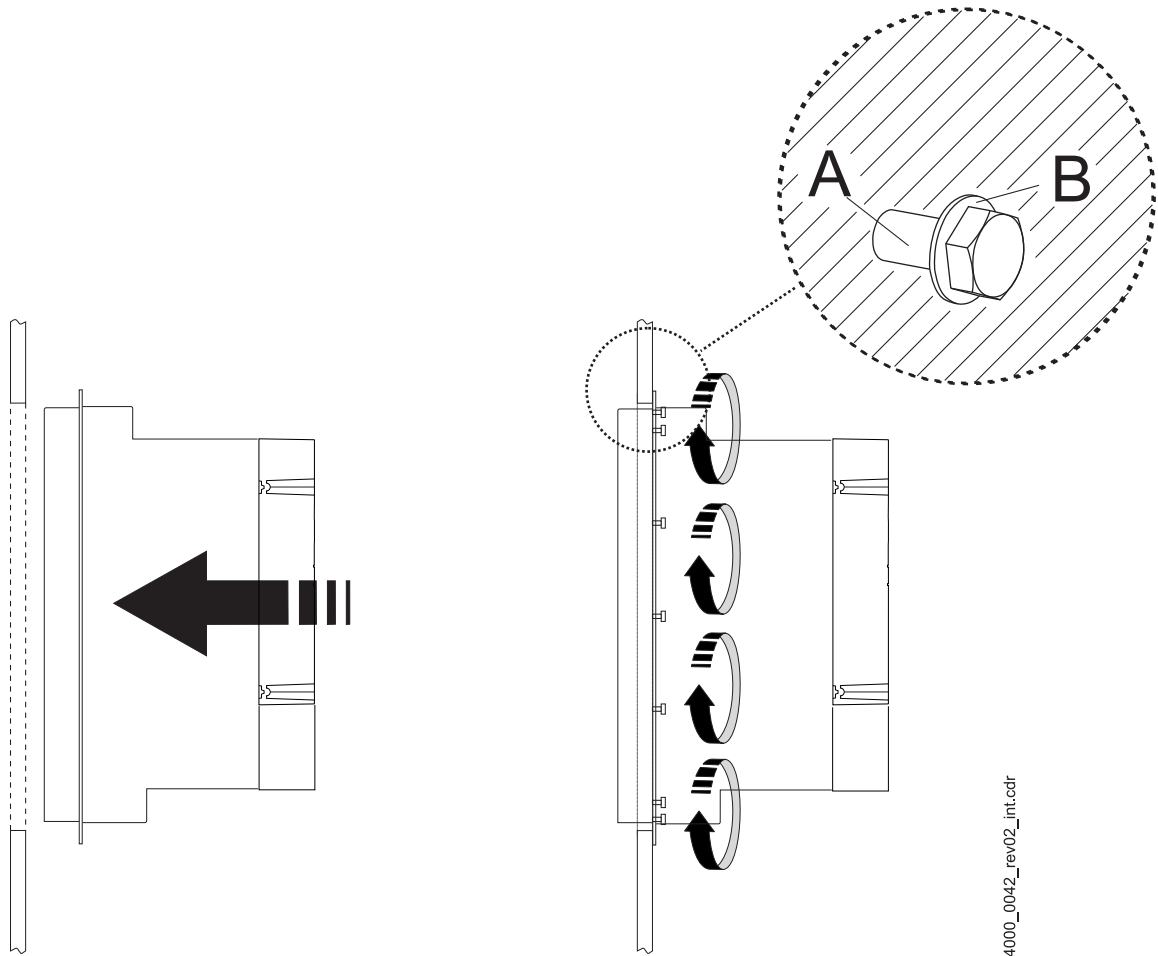

Figure 73: Mounting instruction BM447X-A/F, BM477X-FXX-3XXXX

Device	BM447X-A	BM447X-F, BM477X-FXX-3XXXX
A - Screws	38 x M6	22 x M6
B - Spring washers	38 x DIN6796-6-FST	22 x DIN6796-6-FST
C - Washers	38 x (6.4 x 12.5)	22 x (6.4 x 12.5)

4000_0514_rev02_int.cdr



4000_0042_rev02_int.cdr

Figure 74: Mounting instruction „diverse“

Device	BM442X-A/F/Z/C	BM443X-A/F/C BM463X-F	BM444X-A/F BM464X-F	BM445X-A/F BM465X-F	BM446X-A/F BM466X-F
A - Screws	4 x M5	14 x M4	16 x M5	16 x M8	20 x M8
B - Washers	4 x (5.3 x 10)	14 x (4.3 x 9)	16 x (5.3 x 15)	16 x (8.4x21)	20 x (8.4x21)

Device	BM465X-FXX-3XXXX BM475X-FXX-3XXXX	BM466X-FXX-3XXXX BM476X-FXX-3XXXX
A - Screws	18x M6	18 x M8
B - Washers	18 x (6.4x17)	18 x (8.4x21)



WARNING!

Danger because of conductive fluid in connection with electricity!

- 1 The mounting drills are outside of the gasket. With non-waterproof fastening holes, e. g. the liquid coolant can ingress into the control cabinet.
- Seal the mountings against water. Use, e.g., waterproof draw-in bolts and sealants between screws and bolts.

Type of protection: control cabinet with built in through-hole devices BM442X-A/F



NOTE

The following required control cabinet mounting is only valid for control cabinets with protection class IP54 or higher.

- IP protection class for air-cooled through-hole devices: IP44
- IP protection class for water-cooled through-hole devices: IP54

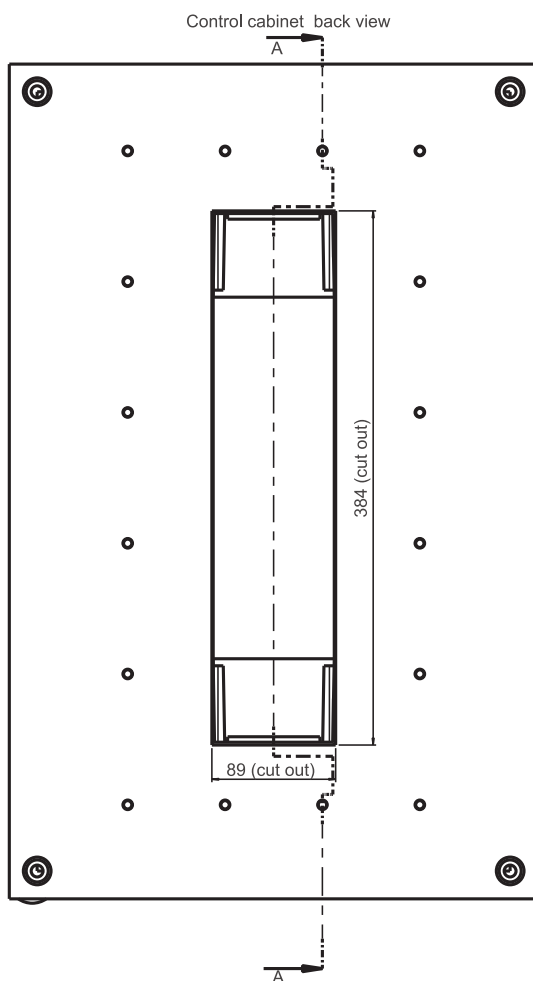

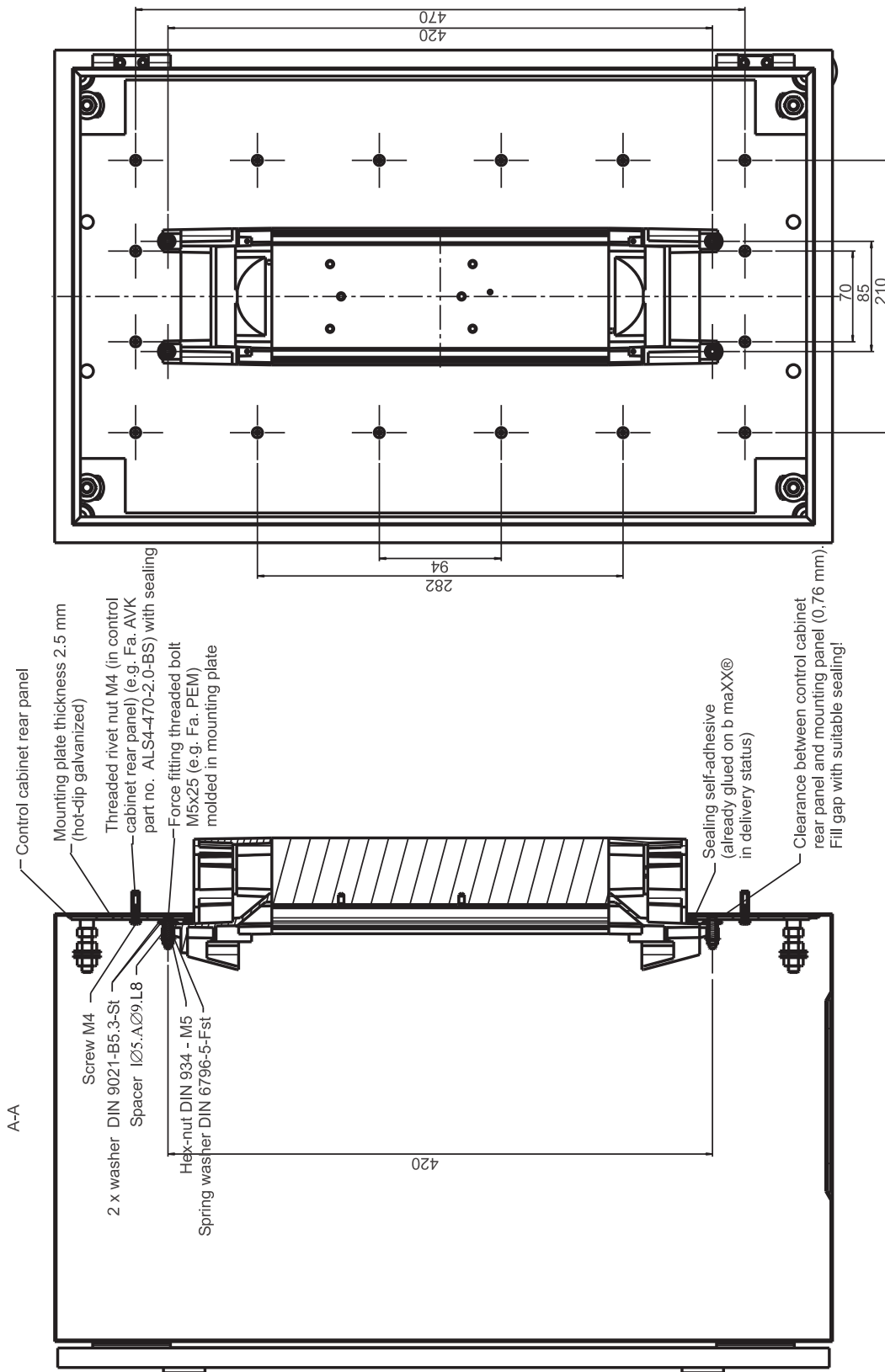

Figure 75: Control cabinet mounting BM442X-A/F

6.3 Mounting instructions

6.3.1 Requirements mounting plate for cold plate

The cooling version cold plate is a particular efficient cooling alternative. The heat dissipation is done via 2 contact surfaces. The first one is the mounting platform within the control cabinet or on the machine base, the other is the cold plate on the device's back. High requirements e.g. to surface roughness and evenness for this surface are specified, to ensure an optimal heat flow. Already a slight damage/pollution of the surface can cause a significant deterioration in heat dissipation to the mounting plate.

For this reason while handle the units protect the sensitive function surface to avoid damage.

Surface flatness (across the entire surface)	0.05 mm
Surface roughness Ra	1.2 µm
Material of the plate (recommendation)	AlMgSi 0.5



NOTICE!

Property damage due to overheating

Scratches and burrs can inhibit the heat dissipation of cold plate devices.

Therefore

- When mounting cold plate devices, ensure that the surface quality of the mounting plate meets the specifications and ensure that the device's rear panel/mounting plate does not have any scratches or burrs.

6.3.2 Connecting the water cooler

With water cooled devices (BM44XX-F, BM46XX-F, BM47XX-F and BM44XX-Z, BM46XX-Z, BM47XX-Z) you connect the coolant circulation before electric installation. The water cooler has on its bottom side two pressfitting-transition pieces 15 mm x R 1/2" AG for flat seals.

- Connect the cooling circulation to the water coolerr

Tube material	Outer tube-Ø	Screwing
1.4571 X6CrNiMoTi17-12-2	15 mm	1/2' AG for flat washer

In case you refer to UL 508 C: There must be a pressure-relief valve with a threshold pressure of maximum 6 bar in the cooling circulation.

7

INSTALLATION

This chapter describes the electrical installation of the device. The mechanical mounting is described in [►Mounting◄](#) from page 147.

Initial commissioning is described in the **Parameter manual b maXX 4000** in chapter Commissioning.

Prior to installation, ensure that the technical prerequisites have been fulfilled:

- 1 Check the demands on the electrical power supply.
- 2 Check the requirements for the electrical cables and the provision of corresponding cables.
- 3 Check the properties of the connections and the specified configuration of the respective cables.

7.1 Safety notes



NOTE!

Installation shall only be performed by employees of the manufacturer or by other qualified personnel.

Qualified personnel are persons who – on account of their occupational training, experience, instruction and knowledge of relevant standards and stipulations, accident prevention regulations and operating conditions – are authorized by the persons responsible for the safety of the facilities to perform the respective activities that are necessary, while at the same time recognizing and preventing any potential risks. The qualifications necessary for working with the device are, for example:

- Occupational training or instruction, and the authorization to commission, ground and mark electrical power circuits and devices in accordance with the standards of the safety engineering.
- Occupational training or instruction, in accordance with the standards of work safety, for the care and use of appropriate safety equipment.



WARNING!

Danger because of faulty installation and initial commissioning!

Installation and commissioning require qualified personnel with adequate experience. A installation fault can cause danger situations or large damage of property.

Therefore:

- Only personnel from manufacturer or qualified personnel operate while installation and initial commissioning



DANGER!

Risk of fatal injury from electrical current!

Inevitably, when operating this electrical device, certain parts of it are energized with hazardous voltage.

Therefore:

- Pay heed to areas on the device that could be dangerous during the electrical installation.
- Pay heed to areas on the device that could still be electrically energized after operation.

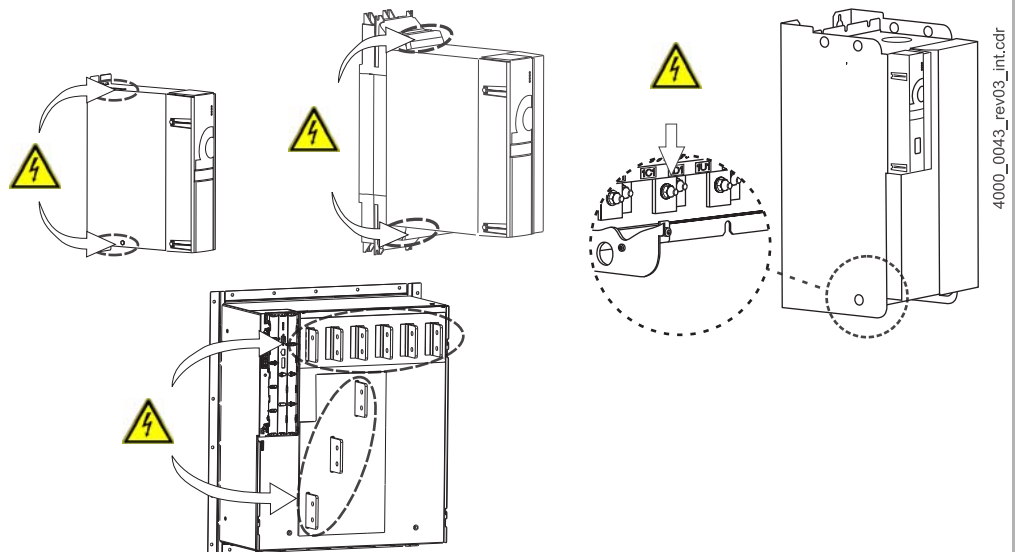

Danger from residual energy

**DANGER!****Risk of fatal injury from electrical current!**

Stored electric charge.

Discharge time of the system = discharge time of the device with the longest DC link discharge time in the DC link connection.

Refer to [►Electrical data basic units◄](#) from page 65.

Therefore:

- Do not touch before taking into account the discharge time of the capacitors and electrically live parts.
- Heed corresponding notes on the equipment.
- If additional capacitors are connected to the DC link, the DC link discharge can take a much longer time. In this case, the necessary waiting period must be determined or a measurement made as to whether the equipment is de-energized. This discharge time must be posted, together with an IEC 60417-5036 (2002-10) warning symbol, on a clearly visible location of the control cabinet.

7.2 Voltage test

**DANGER!****Risk of fatal injury from electrical current!**

During the routine test of these devices, a voltage test is performed by Baumüller Nürnberg GmbH in accordance with EN 61800-5-1, Section 5.2.3.2. It is thus unnecessary for the customer to do this.

Therefore:

- Subsequent tests of the devices using high voltages may only be performed by Baumüller Nürnberg GmbH.
- Disconnect the converter from the system during high-voltage testing!

7.3 Demands on the power supply

For all important data, refer to [►Requirements to the energy supply / supply system◄](#) from page 54.

Minor deviations from requirements in the power supply can lead to malfunctioning of the device. If the power supply deviates too much from the requirements, the device can be destroyed.

The devices may only be operated in industrial networks.

The destruction of the device can cause personal injury.



DANGER!

Risk of fatal injury from electrical current!

If the requirements for the power supply are not complied, the device can be damaged or destroyed, thereby greatly endangering individuals.

Therefore:

- Prior to installation, ensure that the demands for power supply have been fulfilled.

7.3.1 Connection instructions at special power supply systems

Note: Not valid for **b maXX** power modules.

- Single phase connection (BM441X)

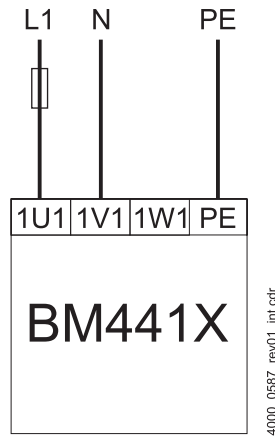

Figure 76: Single phase connection BM441X

- Connection to single phase grounded power supply systems (BM442X for IT systems, BM443X ... BM447X)

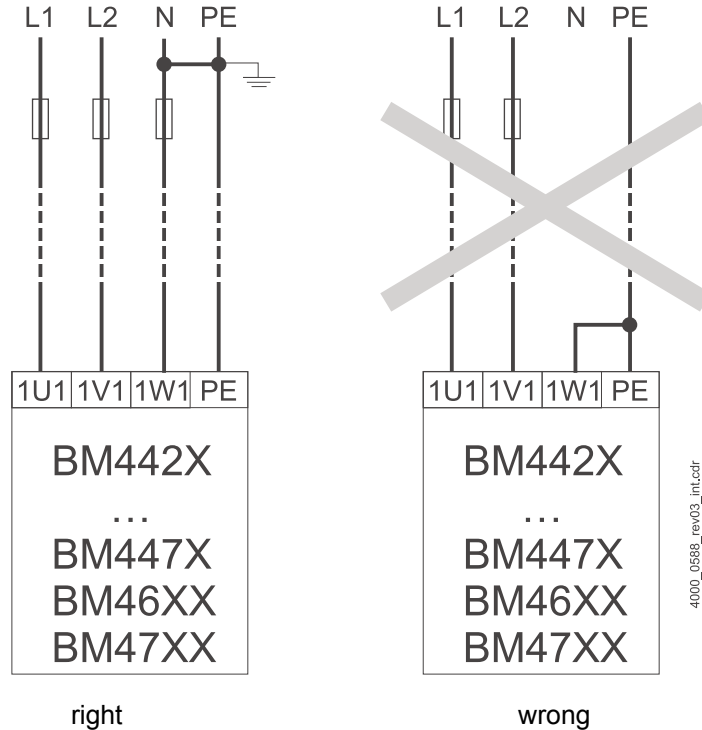

Figure 77: Single phase connection (BM442X ... BM447X, basic units)

7.4 Requirements to the connecting cables

- Connection to single phase grounded power supply systems with isolated transformer for the following cases
 - 1) BM441X, BM442X except for IT power supply systems
 - 2) BM443X ... BM447X, BM46XX, BM47XX at operating altitude > 2000 m

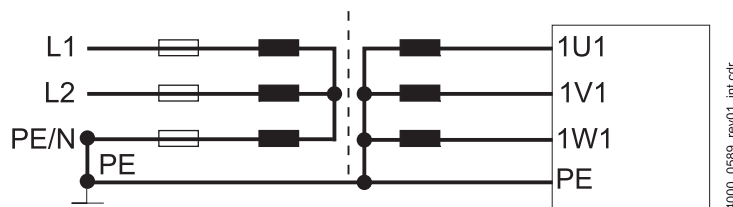

Figure 78: Connection to single phase grounded power supply systems with an isolated transformer

7.4 Requirements to the connecting cables

- ◆ Take into account IEC/EN 60204-1, Chapter 13 when selecting the cable.
- ◆ The protective ground cross-section of the cable must be compliant with IEC/EN 60204-1, Section 5.2, Tab. 1.
- ◆ A fixed connection for the protective ground conductor is mandatorily specified for operation of the device.
- ◆ Use copper cable approved for a minimum of 60 °C (drives < 3 x 100 A) or 75 °C (drives ≥ 3 x 100 A), if comply with UL 508C.

For further details (e.g. maximum permitted length), refer to [▶Cabling◀](#) from page 274.

7.5 Protection of the device and the cable

Fuses must be installed to protect this device and the cables against overload and possible damage/destruction through the electrical power supply. For data on the required fuses, refer to [▶Fuses◀](#) from page 279.

7.6 PE connection and RCD compatibility

Depending on the functional principle, leakage current $>3.5 \text{ mA}_{\text{AC}}$ or $>10 \text{ mA}_{\text{DC}}$ can flow through the protective ground conductor. Consequently, a stationary ground conductor connection in accordance with EN 61800-5-1 is required.



DANGER!

Risk of fatal injury from electrical current!

This product can cause direct and/or alternating current in the protective ground conductor.

The leakage current, due to the functional principle of the device, can lead to premature triggering of the fault current protective device or generally prevent triggering of it.

Therefore:

- Wherever a differential current device (RCD) is used for protection in case of direct or indirect contact, only an RCD of the type B is permitted on the power supply side of the device.
- Otherwise a different protective measure must be utilized, such as separation from the surroundings by means of double or enhanced isolation, or separation from the power supply system by means of an isolating transformer, for example.

7.7 Installation requirements with regard to EMC



NOTE!

The emission of radio frequency interference (RFI) is to a great extent dependent on the wiring, spatial expansiveness and the arrangement of the components in the system. Ensuring electromagnetic compatibility compliance in accordance with legal requirements is therefore only possible on the completely assembled system and is thus the responsibility of the system manufacturer or proprietor (re Art. 6, Par. 9 of the EMVG; European EMC law).



NOTE!

The important information on EMC-compliant installation can be found in these instruction handbook. Additional notes on building a CE-compliant system, that are imperative to take heed of, can be found in the Baumüller manual „Mains filter BFN“, 5.09010. This manual can be obtained from Baumüller Nürnberg GmbH.

7.8 Avoid bearing currents

In order to have EMC-compliant and problem-free use within the framework of the legislation, the following aspects must be taken into account.

In case of any questions, please contact Sales or the Applications department of Baumüller Nürnberg GmbH.

- Only use Baumüller motor cables and Baumüller components.
- Use suitable mains filters recommended by Baumüller Nürnberg GmbH.
- Mount all components on a single mounting plate with a continuously good electrically-conductive surface (e.g. galvanized steel plate).
- Keep the ground connection device/ground plate as short as possible (< 30 cm), using fine-stranded cables with a large cross section (>10 mm²).
- When installing, be sure to follow the correct sequence:
power supply system - fuse - filter - choke - (ferrite core) - **BM4400, BM4600, BM4700** - (motor filter) - motor.
- Ensure that the motor cable is continuous, without interruption.
Do not interrupt motor cables with terminals, contactors or fuses, for example.
- If possible route the cables on the surface of the grounded mounting plate (i. e. the least effective antenna height).
- When routing in parallel, minimum clearance of 20 cm should be observed between signal and control cables vis-à-vis the power cables.
- Cables of different EMC categories (e.g. signal cables - mains cables and/or motor cables) should be crossed at a 90 ° angle.
- Contact the major cable shield when laying cables through walls, which separate different EMC areas
- Contact all the cable's shields on both sides surface-to-surface and also well-conductive with ground.

7.8 Avoid bearing currents



NOTE

The pulsed output voltage of a converter causes additional motor bearing currents.

Bearing currents cause localized melting on ball race and rolling body as well as wear of the lubricant. This leads to a reduced service life of the bearing.

Bearing currents depend on:

- Motor speed
- Switching frequency of the converter
- Grounding

Furthermore the height of the bearing currents depends on:

- the applied bearing voltage
- the dielectric characteristic of the bearing lubrication

**NOTE**

The reduction of bearing currents requires the consideration of the **whole speed-variable drive system** and its installation!

Baumüller supports you with on-site measurements and with development and implementation of suitable preventative measures.

Avoiding bearing damage

- Basically the **grounding system** must be installed appropriately to ensure a forced return of the common mode current.
- The cause of bearing current damage, that means the amplitude and slope of the common mode voltage is reduced by using toroidal cores. The use of toroidal cores is therefore a **preferred measure**.
- In addition the using of **current-isolated bearings** (standard for AC drives from motor size 180 and higher) can reduce the effects of the common mode voltage.
- The shaft can be grounded (and the bearing currents redirected) by using special grounding rings or grounding brush(es).
- Furthermore modified **motor cables** (for high frequencies, cable shield with low impedance, symmetric cable design) can be used in order to lead the capacitive currents to a large extent back to the converter via the cable shield.

Toroidal cores**NOTE**

It is recommended to use toroidal cores in order to reduce/to avoid bearing currents.

Part numbers and the number of recommended toroidal cores, refer to [▶Toroidal cores](#) on page 311 in chapter Accessories and Spare Parts.

- The toroidal cores are made of nanocrystalline material. The toroidal cores cover all three phases of the converter output. The time variable common mode current induces a magnetic field into the toroidal core, which counteracts against the change of the common mode current.
- For this reason the toroidal core operates a current-compensated choke, which limits the rate of change and the amplitude of the common mode voltage and therefore reduces the bearing currents significantly.
- Because of the higher amplitude and frequency of the common mode voltage when using an active mains rectifier unit, there are used toroidal cores with a lower permeability for optimized modulation of the cores (saturation and temperature characteristics).

Installation of toroidal cores

- The three phases **without shielding** and **without PE** must be lead through the cores. The cores must be installed and attached near the motor connection of the **BM4400**, **BM4600**, **BM4700** .
- When using toroidal cores it is further recommended to use current isolated bearings on the nondrive end for synchronous/asynchronous main drives sizes 180 and higher.



Figure 79: Mounting - single ring core



Figure 80: Mounting - several ring cores

7.9 Requirements for the motor temperature sensors

To protect the motor against not permitted overheating, a motor temperature sensor can be connected to the **b maXX** device. The device switches off of the motor when a settable threshold temperature has been exceeded.



NOTICE!

The motor must be protected against overtemperature according EN 61800-5-1. The device's integrated monitoring function „Overtemperature Motor“ fulfills this requirement.

The user is responsible for realization of the motor overtemperature monitoring according EN 61800-5-1 in case the used motor is not equipped with a motor temperature sensor or the sensor is not connected.



NOTE!

The thermal memory of the motor and the speed-dependent electronic motor overload protection is not available if no motor temperature sensor is used.

Type	Additional requirements:	Isolation
KTY84/PT1000	-	SELV/PELV
MSKL ¹⁾ (PTC)	$R = 1 \text{ k}\Omega$ at $T_{\text{Threshold}}$, $I_{\text{max}} < 2 \text{ mA}$	SELV/PELV

¹⁾ Motor protection resistor (PTC) as per DIN 44080-082



NOTE!

The motor temperature sensor should be installed in such a manner that „safe electrical separation“ is ensured. The motor temperature sensors integrated into Baumüller motors meet these requirements. If third-party motors are connected, the proprietor must ensure that the temperature sensors used in the motor of a third-party manufacturer motor comply with the „safe electrical separation“ function.

7.10 Installation procedure



DANGER!

Risk of fatal injury from electrical current!

Electrically live parts are life-threatening.

Therefore:

- Make certain that the parts to be mounted (e.g. power supply cables) and the mounting areas are de-energized for the entire duration of mounting the device.



HINWEIS!

Steps which are not necessary for the installation of **b maXX power modules** are marked.

- Lay all cables EMC-compatible.
- Connect cables (refer to [▶Wiring diagrams◀](#) from page 180).
(Observe the torques!)

The following steps must be carried out at installation:

- 1** Connect the motor through terminals 1U2, 1V2, 1W2 and PE.
Ensure the proper phases when connecting (rotational direction).
Use toroidal cores if necessary, refer to [▶Avoid bearing currents◀](#) from page 174.
Observe the permitted torques!
- 2** Connect fuses (S1) - **not necessary for power modules**
(in case you consider UL 508 C: use the UL-listed semiconductor- or total-range-fuses in chapter [▶Fuses◀](#) from page 279).
- 3** Connect mains filter (L2) - **not necessary for power modules**.
- 4** Connect the power choke (L1) at the mains filter output
(**not necessary for BM441X, BM442X (except BM4426) and for power modules**).
- 5** Connect the device via the power supply terminals 1U1, 1V1 and 1W1 to the power choke output - **not necessary for power modules**.
- 6** Connect the protective conductor to the terminal PE (a fixed ground conductor connection is mandatorily specified).
- 7** Connect 24 V power supply:
Terminals X100-1/2, X100-5/6
(if UL 508C is being considered, then limit the current to 4 A).

- 8 Connect encoder(s) (for further information, refer to handbook encoder modules, 5.01042).

**NOTE!**

Plugging in and pulling out encoder cables while they are energized is prohibited, and could lead to their destruction. Therefore, always first switch off the 24 V supply voltage and lock the encoder connectors when operating.

- 9 Connect the temperature sensor of the motor. (Observe the proper polarity!)
- 10 Connect the signal generator for the pulse enable:
terminals X3-5, X3-3
- 11 Connect the signal generator for the quick stop:
terminals X3-4, X3-3
- 12 Perhaps connect (dependent on the application - **not necessary for power modules** - a brake resistor (R_B) via terminals Ba+, Ba-.
- 13 Connect the brake of the motor (option):
Terminals X101-1/2 and X101-3/4
Assignment pre-assembled Baumüller cable see motor documentation.
- 14 Connect the safety relay (if existing) via X102-3 and X102-4 as well as X103-3 and X103-4 (connection data safety relay also refer to [►D.5 Technical data safety relay module◄](#) on page 374).

7.11 Wiring diagrams

7.11.1 Connection diagrams

7.11.1.1 BM44XX, BM46XX, BM47XX (basic units)

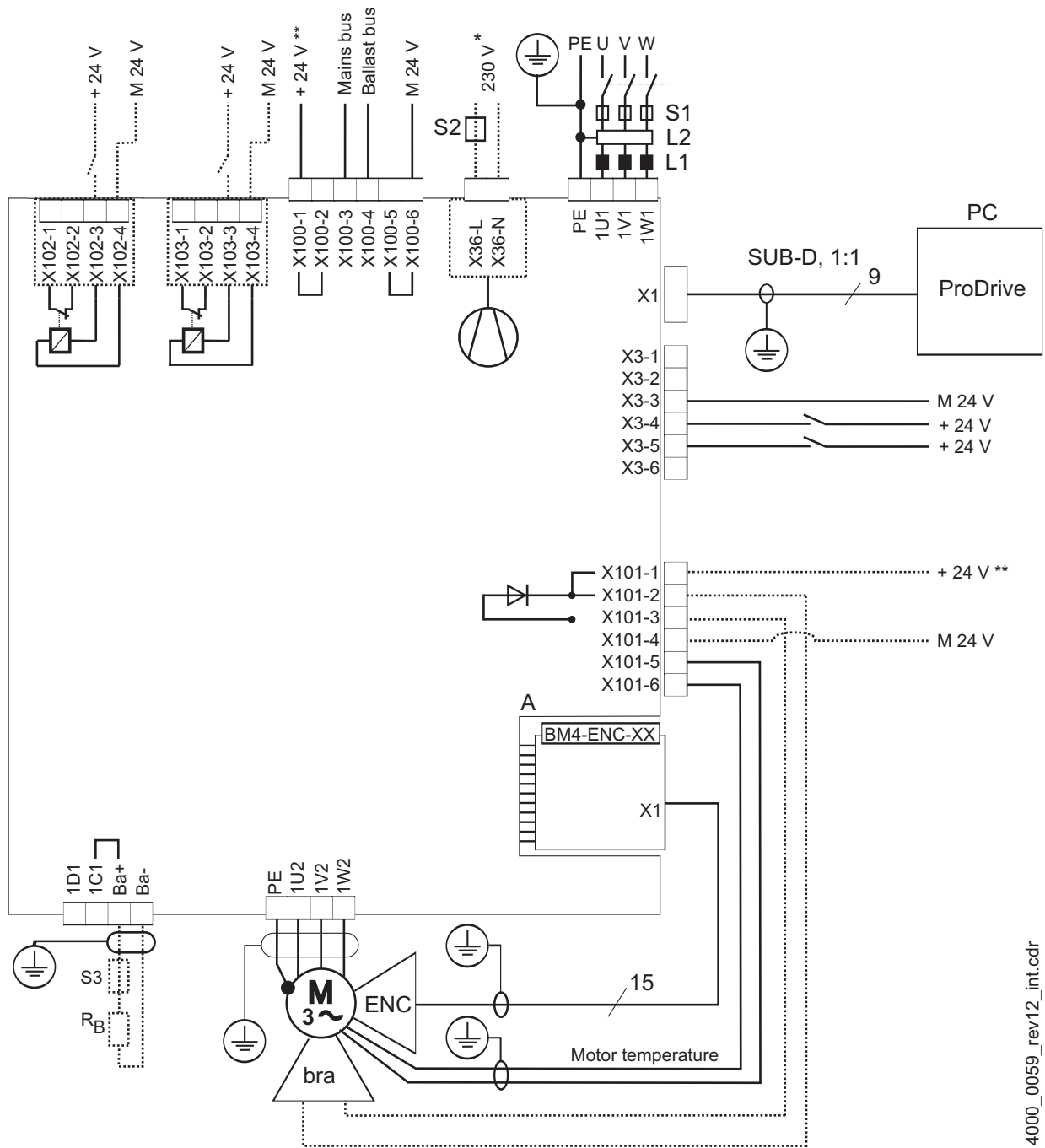

4000_0059_rev12_int.cdr

Figure 81: Connection diagram with a directly controlled motor brake - basic units

**HINWEIS!**

If the motor brake is connected directly via X101-2 and X101-3 (refer to [▶Figure 81◀](#) on page 180), the shown direct installation is allowed only. It is not allowed within a multi-axis installation e.g. to connect the plus and ground connections of all motor brakes with each other.

An additional relay is necessary, if the voltage of the brake is $\neq 24V$, or if the current of the brake is greater than the switching capacitance of X101 (refer to [▶X101 \(SELV/PELV\)◀](#) on page 201) or if you consider UL508C and the current of the brake is greater 4 A. Perhaps consider a limited operating voltage range of the brake because of the internal voltage drop up to max. 2.6 V.

7.11 Wiring diagrams

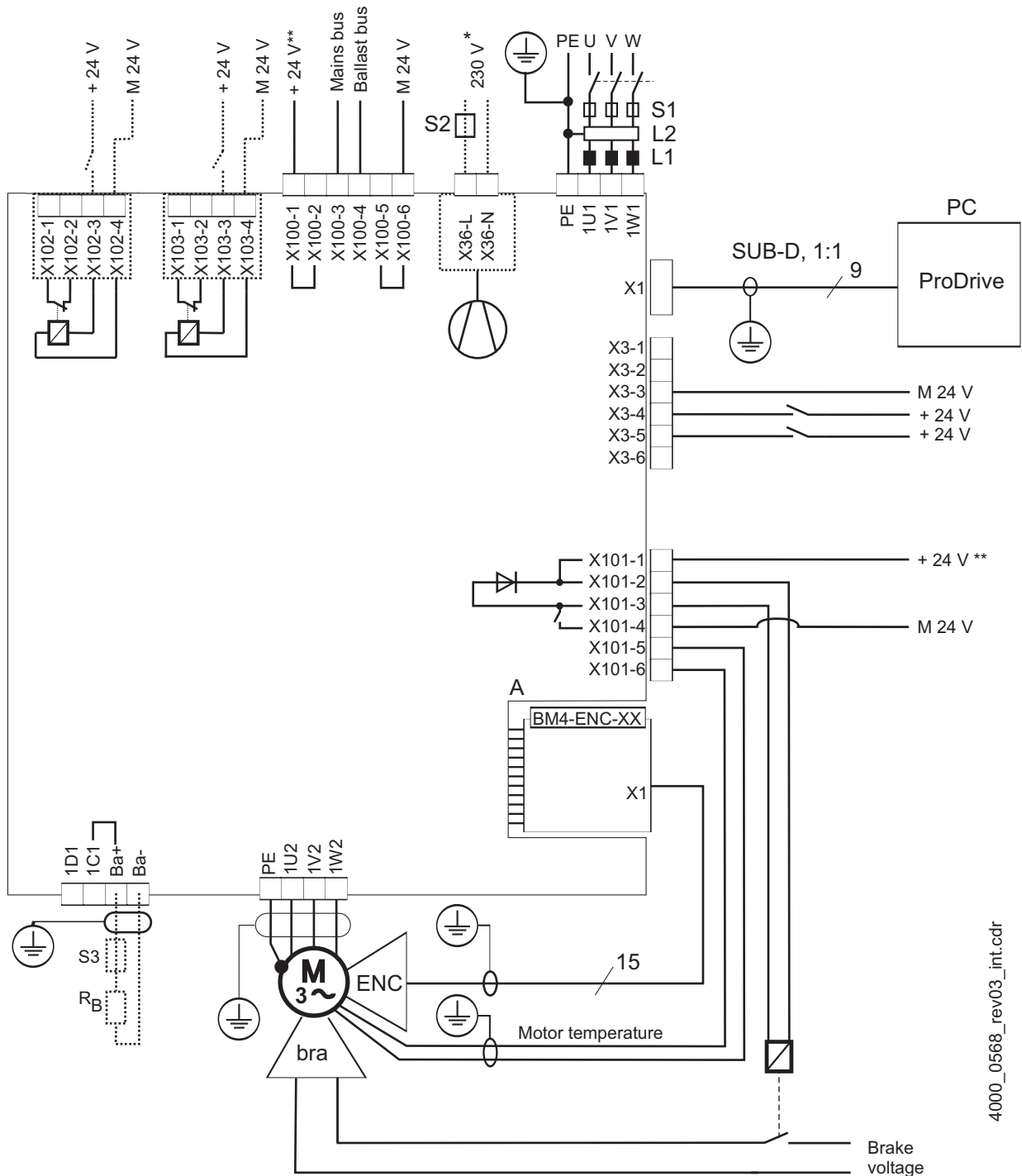

4000_0568_rev03_int.cdr

Figure 82: Connection diagram with motor brake controlled via an add. relay - basic units

7.11.1.2 BM44XX, BM46XX, BM47XX power module

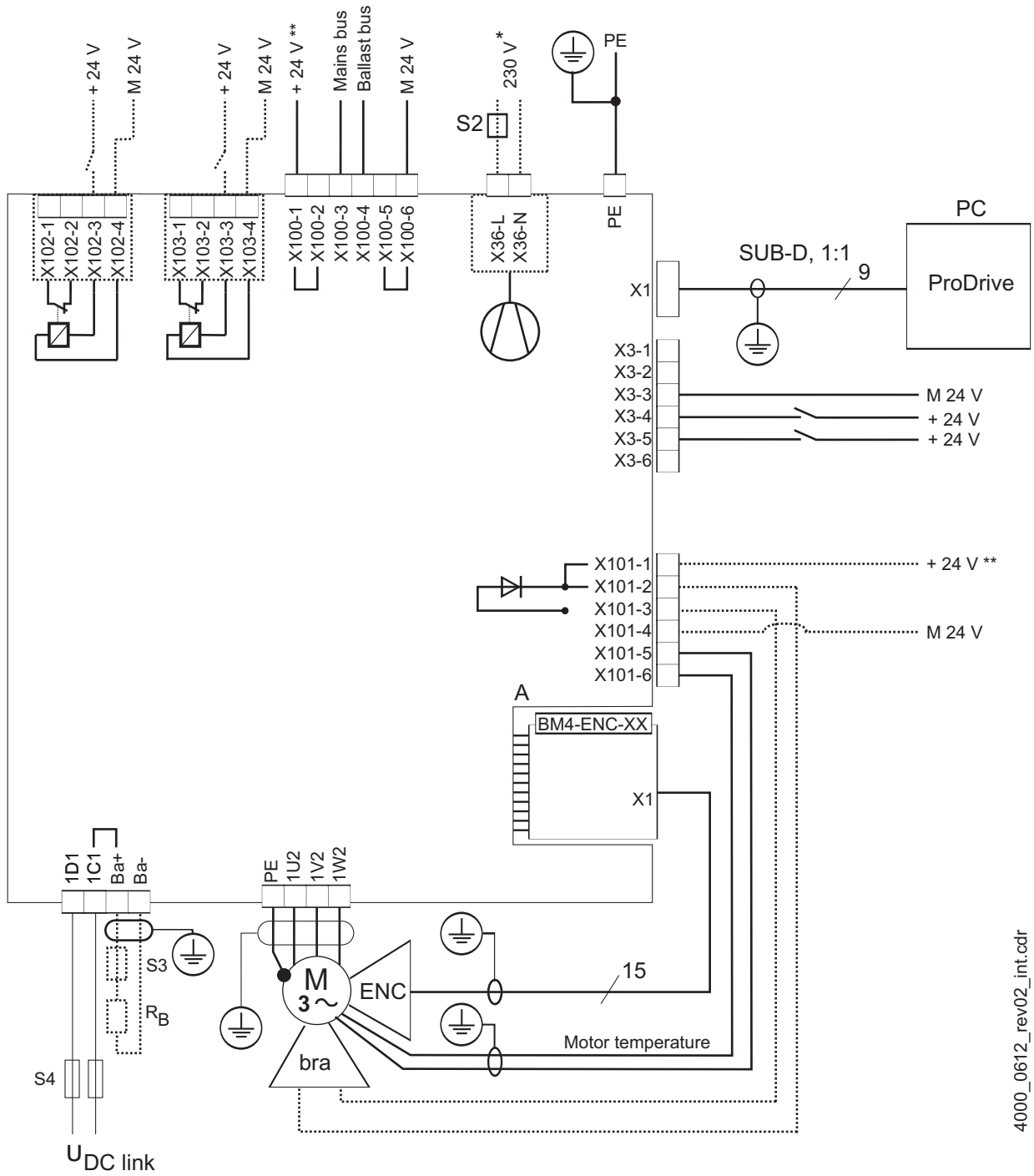

4000_0612_rev02_int.cdr

Connection to other BM41XX or BM44XX units

Figure 83: Connection diagram with a directly controlled motor brake - power modules



NOTE

If the motor brake is connected directly via X101-2 and X101-3 (refer to [▶Figure 81◀](#) on page 180) the shown direct installation is allowed only. It is not allowed within a multi-axis installation e.g. to connect the plus and ground connections of all motor brakes with each other.

An additional relay is necessary, if the voltage of the brake is $\neq 24V$, or if the current of the brake is greater than the switching capacity of X101 (refer to [▶X101 \(SELV/PELV\)◀](#) on page 201) or if you consider UL508C and the current of the brake is greater 4 A. Perhaps consider a limited operating voltage range of the brake because of the internal voltage drop up to max. 2.6 V.

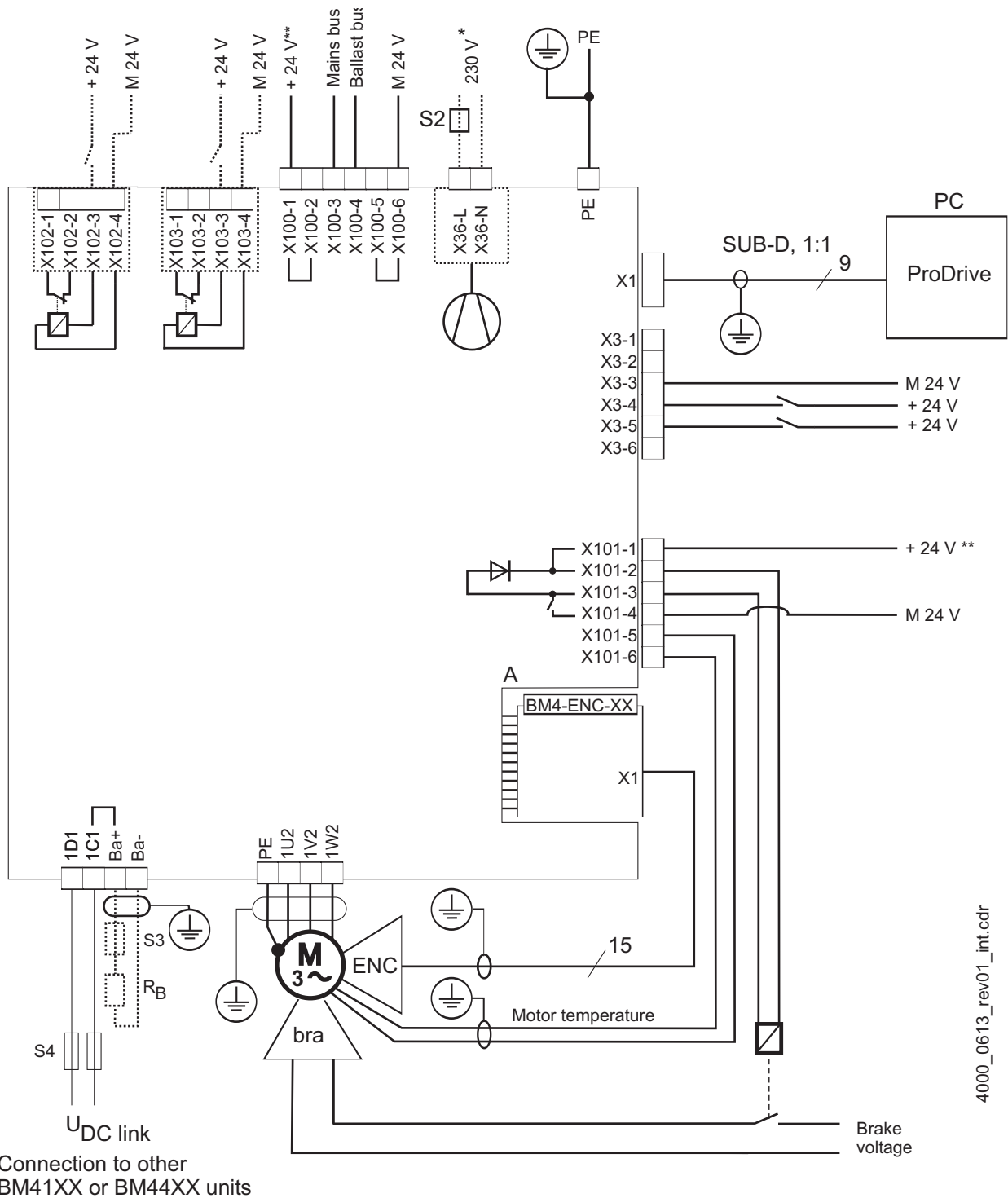

4000_0613_rev01_int.cdr

Figure 84: Connection diagram with motor brake controlled via an additional relay - power modules

- * is only valid for BM444X, BM464X, BM445X, BM465X, BM446X, BM466X accordingly the cooling versions S and A, for BM447X cooling version -A:

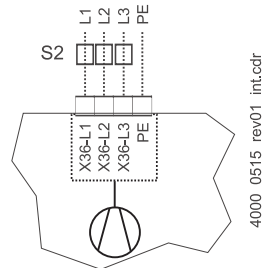

Figure 85: Connection fan

- ** The power supply at X100 or X101 must externally be protected. At selection of the fuse you must consider the cross-section of the connecting cable and the maximum allowable load capacity (for X100: refer to X100 on [Page 201](#), for X101: refer to X101 on [Page 201](#)).
- In case you consider UL 508 C, you must limit the power supply to 100 W or fuse it with a UL-listed 4 A fuse.
- Ba- ... 1D1 Connections for brake resistor and DC link, refer to [Figure 86](#) on page 188 and the following
- R_B Brake resistor
- PE....1W1 Power supply connection, refer to [Figure 86](#) on page 188 and the following
- S1 Fuse (cable + device), refer to [Fuses](#) from page 279
- S2 Fuse (fan) *)
- S3 Fuses brake resistor circuit (required for BM447X, BM477X), refer to [Fuses BM447X](#) on page 298.
- S4 DC link fuse
- L1 Power choke (not necessary for BM441X and BM442X except BM4426)
- L2 Mains filter
- X1 Serial interface (RS 232), refer to [Figure 95](#) on page 203.
- X3 Connections for ready-for-use, quick stop, pulse enable, refer to [Figure 95](#) on page 203.
- X36 Connections for fans (only BM444X-S/-A, BM445X-S/-A, BM465X-S/-A, BM446X-S/-A, BM466X-S/-A, BM447X-A)
- X100 Connections for 24 V power supply, additional data refer to [Figure 95](#) on page 203 (SELV/PELV) and table [X100 \(SELV/PELV\)](#) on page 201.
- X101 Terminals for brake, motor temperature, refer to [Figure 86](#) on page 188 and the following (SELV/PELV) and table X101 from [Page 188](#).

X102	Connections of the safety relay, refer to ▶Figure 86◀ on page 188 and the following (SELV/PELV) and table ▶X102 (option) Safety relay◀ on page 201.
X103	Terminals of the optional, second safety relay (only BM443X - BM447X, BM46XX, BM47XX), refer to ▶Figure 89◀ on page 191 and the following (SELV/PELV) and table ▶X103 (Option) Safety relay◀ on page 201.
A - X1	Encoder module, refer to documentation 5.01042 (SELV/PELV)
ENC	Encoder
BRA	Brake, assignment pre-assembled Baumüller cable see motor documentation.
PE....1W2	Connections for motor, refer to ▶Figure 86◀ on page 188 and the following.

7.11.2 Terminal overviews

[▶Figure 86◀](#) on page 188 and the following show the connections for protective conductors, power supply, motor, brake resistor, DC-link, safety relays and motor temperature sensor (X101). [▶Figure 95◀](#) on page 203 shows the control voltage and the connections of the controller unit.



NOTE!

When having a switched off safety relay it is not possible to use the brake at BM441X and BM442X



NOTE!

The characterization 1C1 and 1D1 is from the standard DIN EN 60445.
1C1 is the connection to the positive DC link cable/current bar and was labeled with ZK+ by Baumüller in the past.
1D1 is the connection to the negative DC link cable/current bar and was labeled with ZK- by Baumüller in the past.



NOTE!

When replacing a BM443X generation 1 by a generation 2 device (differentiation refer to [▶Explanation version code◀](#) on page 134) the fuses must be adjusted as well, refer to [▶Fuses BM4X3X◀](#) from page 286.

Under certain conditions a mix mode of BM443X generation 1 and 2 is possible, refer to [▶Mix mode BM443X generation 1 and 2◀](#) on page 128.

7.11.2.1 Terminals BM4412, BM4413

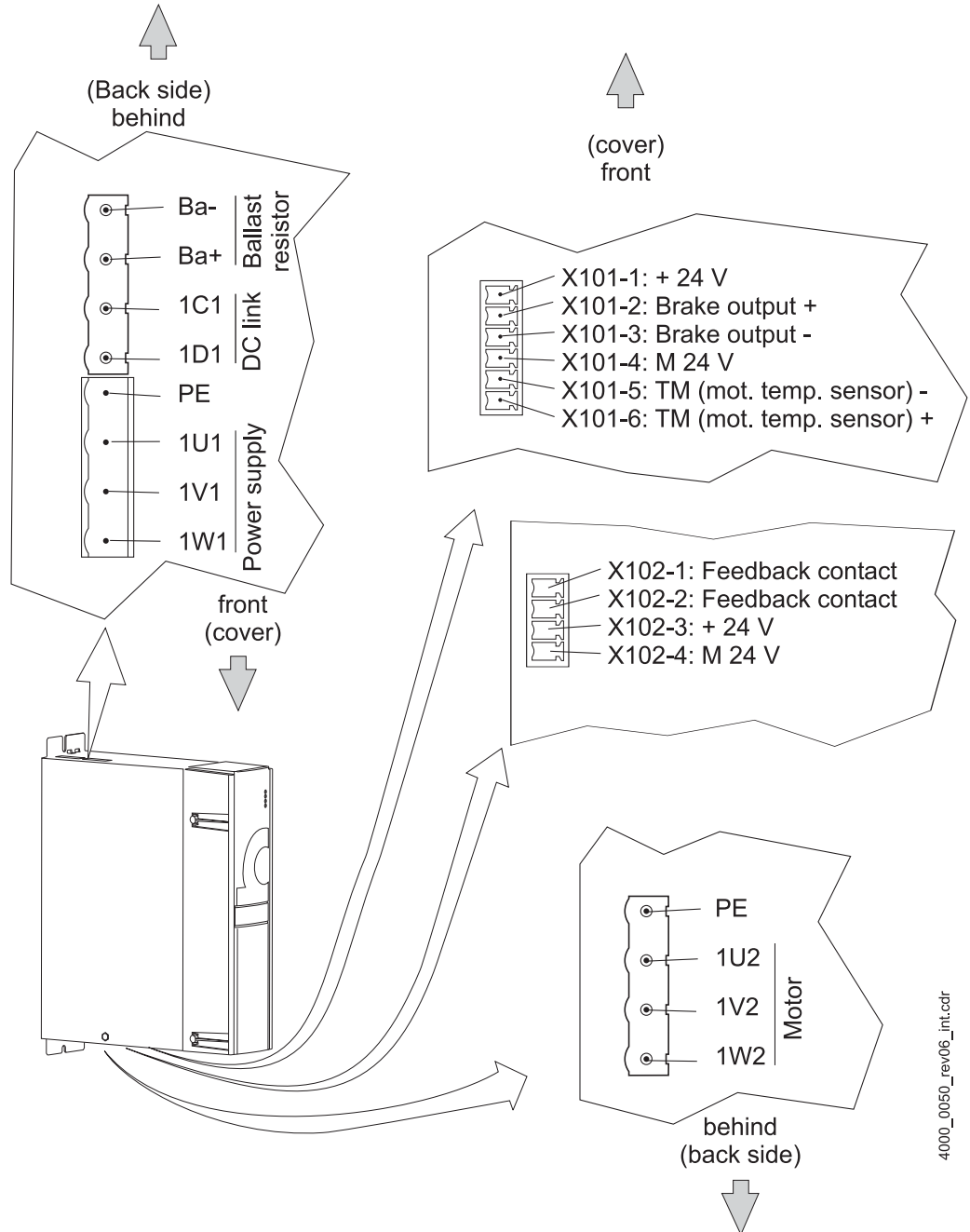

4000_0050_rev06_int.cdr

Figure 86: Electrical connections for power supply, motor, ... for BM4412 and BM4413

7.11.2.2 Terminals BM4414

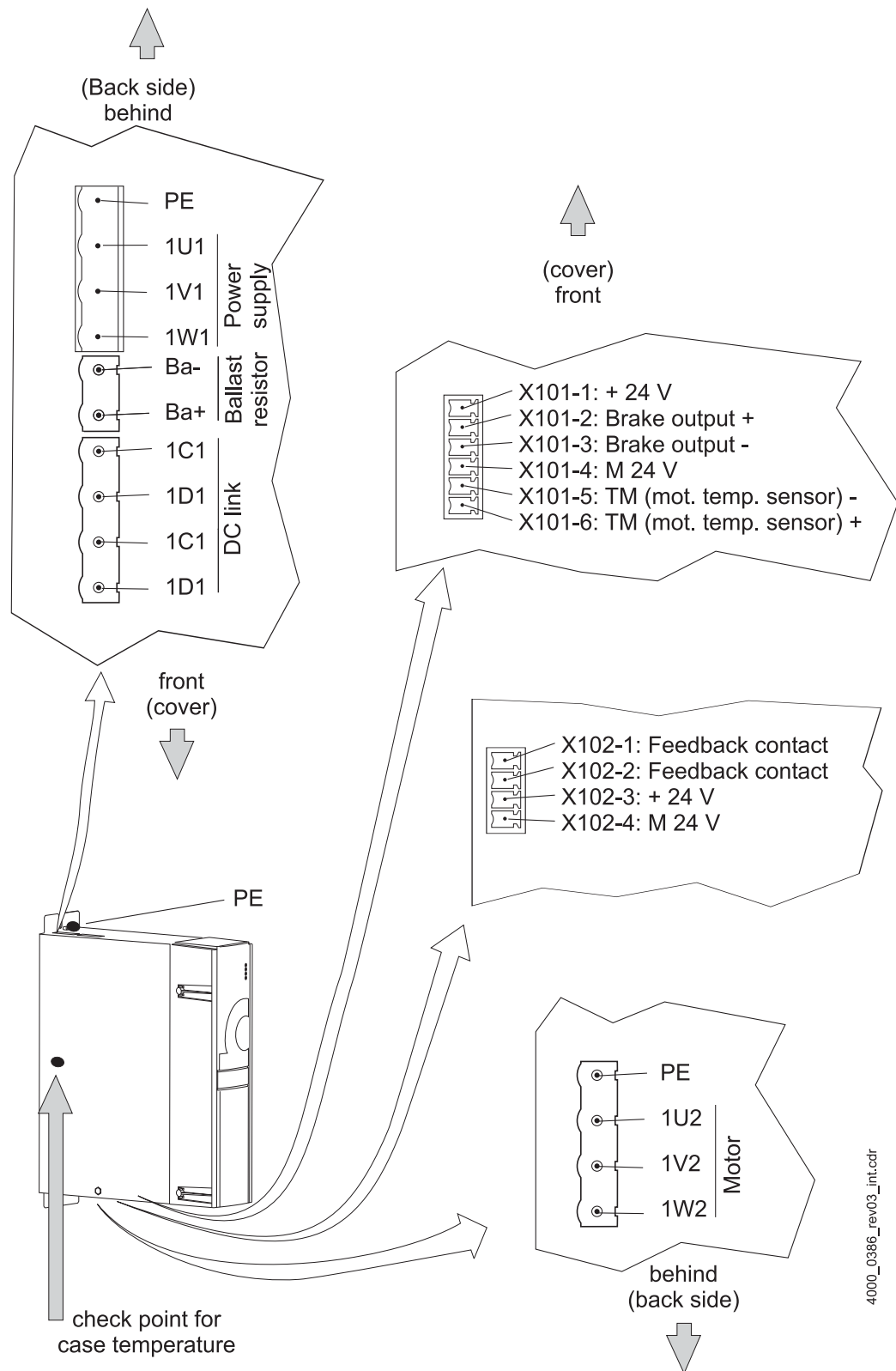

4000_0386_rev03_int.cdr

Figure 87: Electrical connections for power supply, motor, ... for BM4414

7.11.2.3 Terminals BM442X

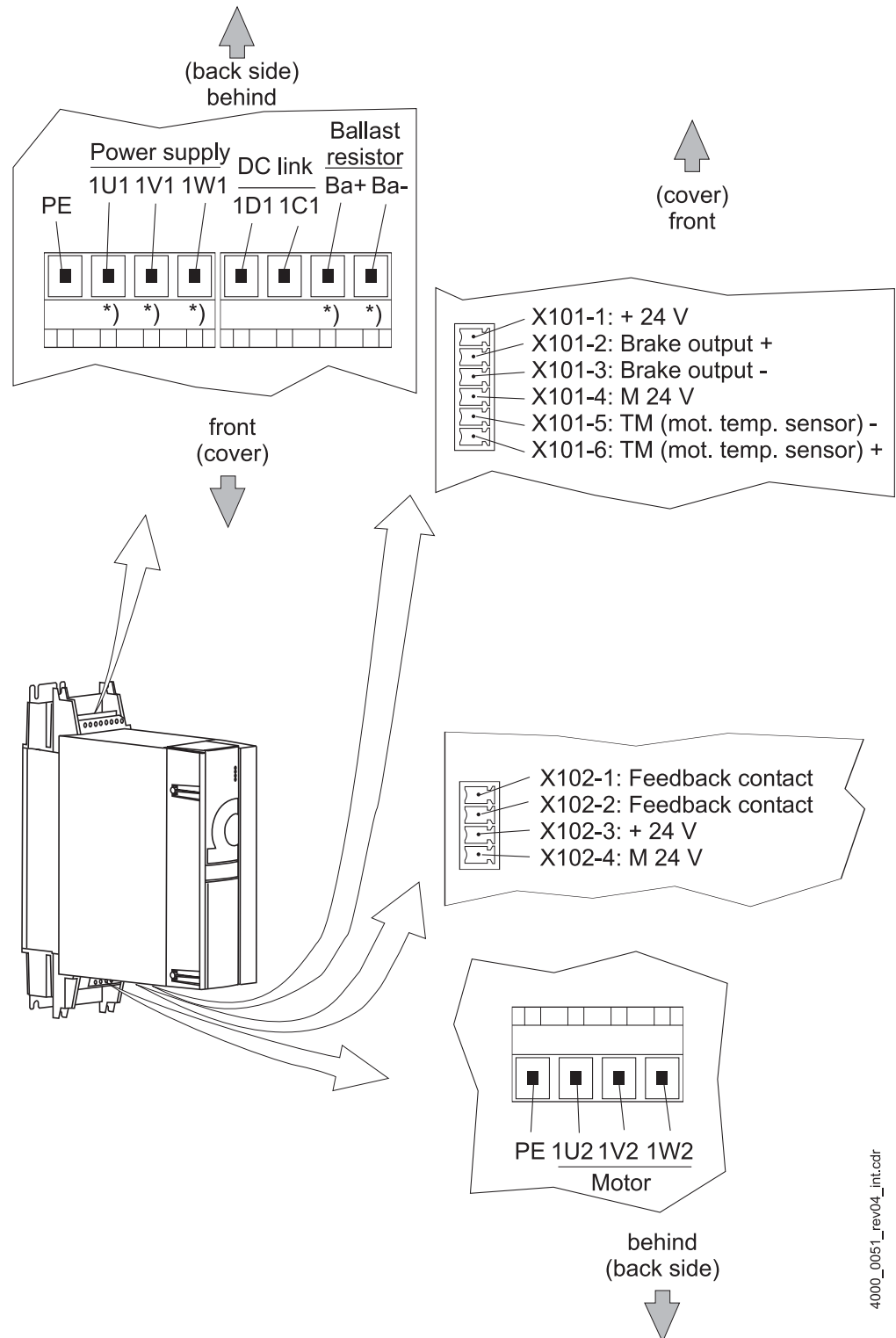

*) Do not apply terminals when using a power module!

Figure 88: Electrical connections for power supply, motor, ... for BM442X

4000_0051_rev04_int.cdr

7.11.2.4 Terminals BM443X, BM463X

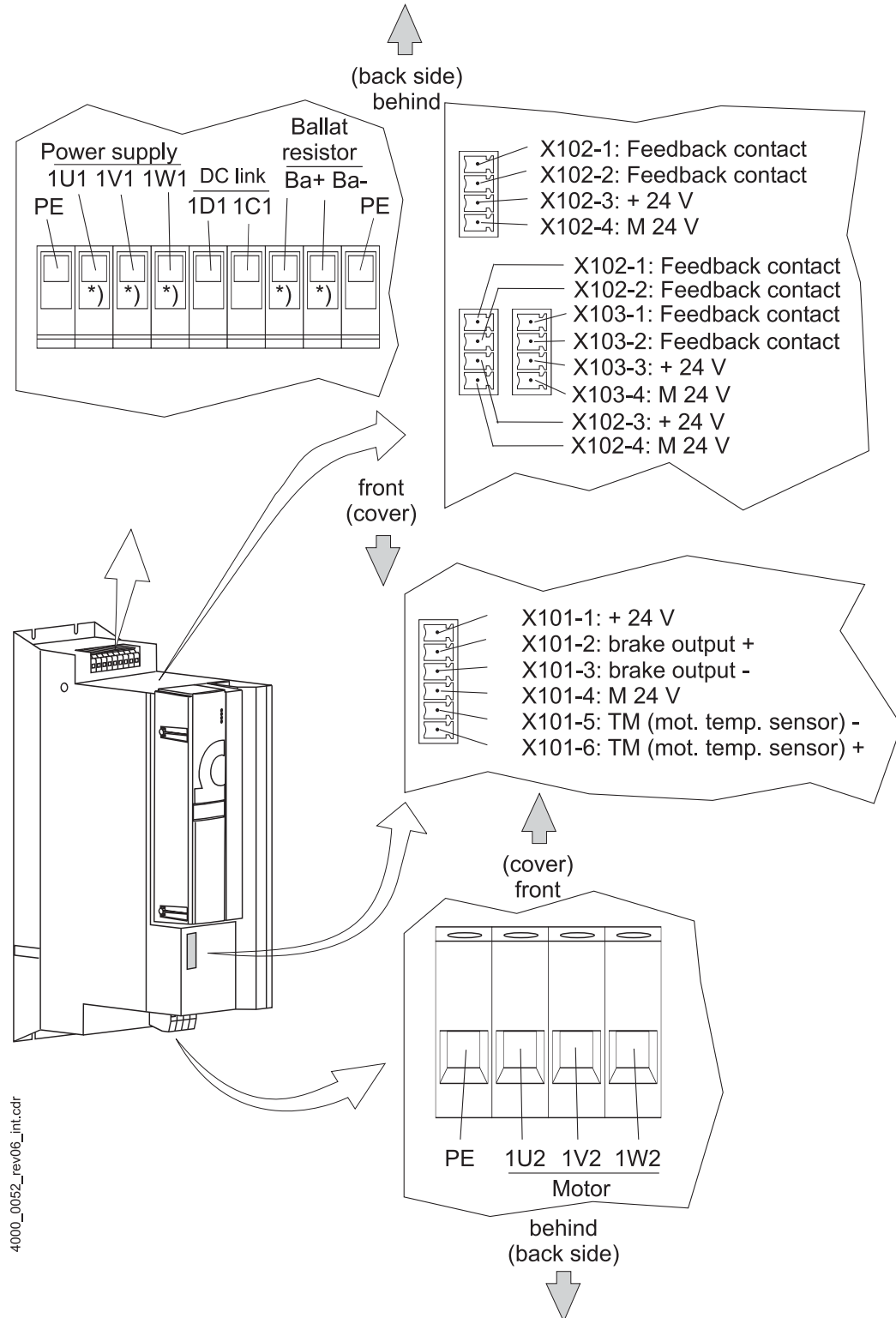

*) Do not apply terminals when using a power module!!

Figure 89: Electrical connections for power supply, motor, ... for BM443X, BM463X

7.11.2.5 Terminals BM444X, BM464X

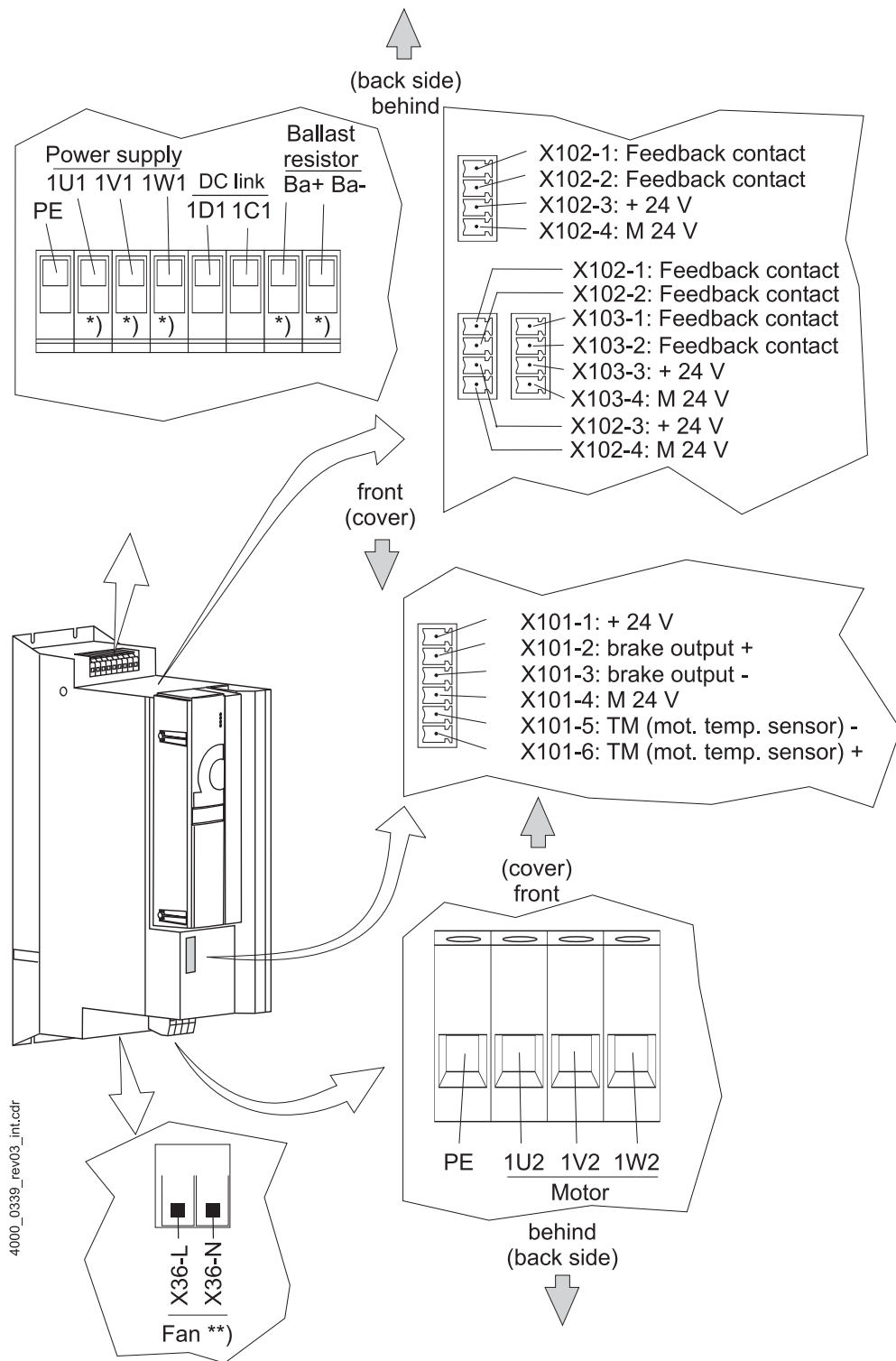

*) Do not apply terminals when using a power module!!

***) only BM444X-S/-A, BM464X-S/-A

Figure 90: Electrical connections for power supply, motor, ... for BM444X, BM464X

7.11.2.6 Terminals BM445X, BM446X, BM465X, BM466X

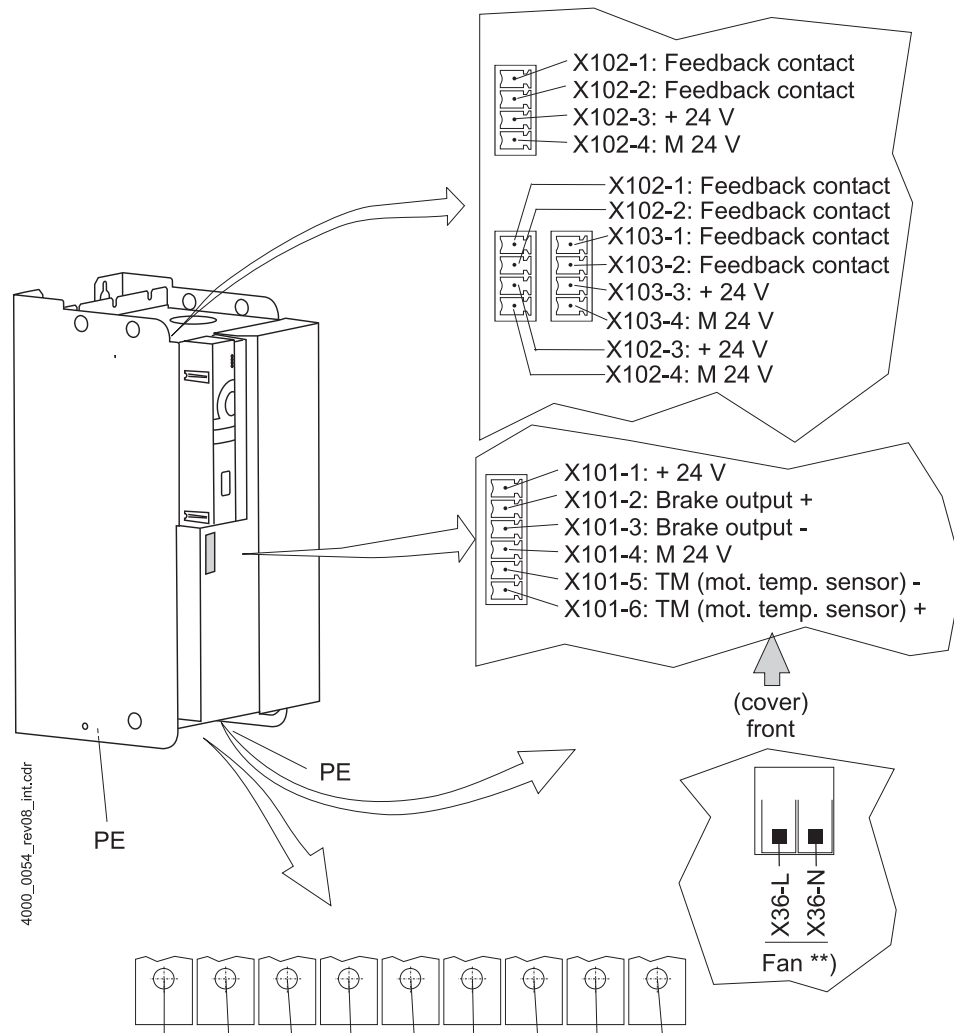

**BM445X,
BM465X without
BM465X-X-3XXXX**

Ba-	1D1	1C1	1U1	1V1	1W1	1U2	1V2	1W2	UL 508 C
Ballast resistor *)	DC link	Power supply *)				Motor			6 to 20 Nm

**BM446X,
BM466X without
BM466X-X-3XXXX**

Ba-	1U2	1D1	1C1	1V2	1U1	1V1	1W2	1W1	UL 508 C
Ballast resistor *)	Motor	DC link	Motor	Power supply *)	Power supply *)	Motor	Power supply *)	Power supply *)	8 to 30 Nm

*) Do not apply terminals when using a power module!!

**) only BM445X-S/-A, BM465X-S/-A and BM446X-S/-A, BM466X-S/-A

Figure 91: Electrical connections for power supply, motor, ... for BM445X, BM465X, BM446X, BM466X



NOTE!

The brake resistor is connected at BM445X and BM446X between Ba- and 1C1. Also refer to >Figure 81< on page 180.

7.11.2.7 Terminals BM466X, BM476X

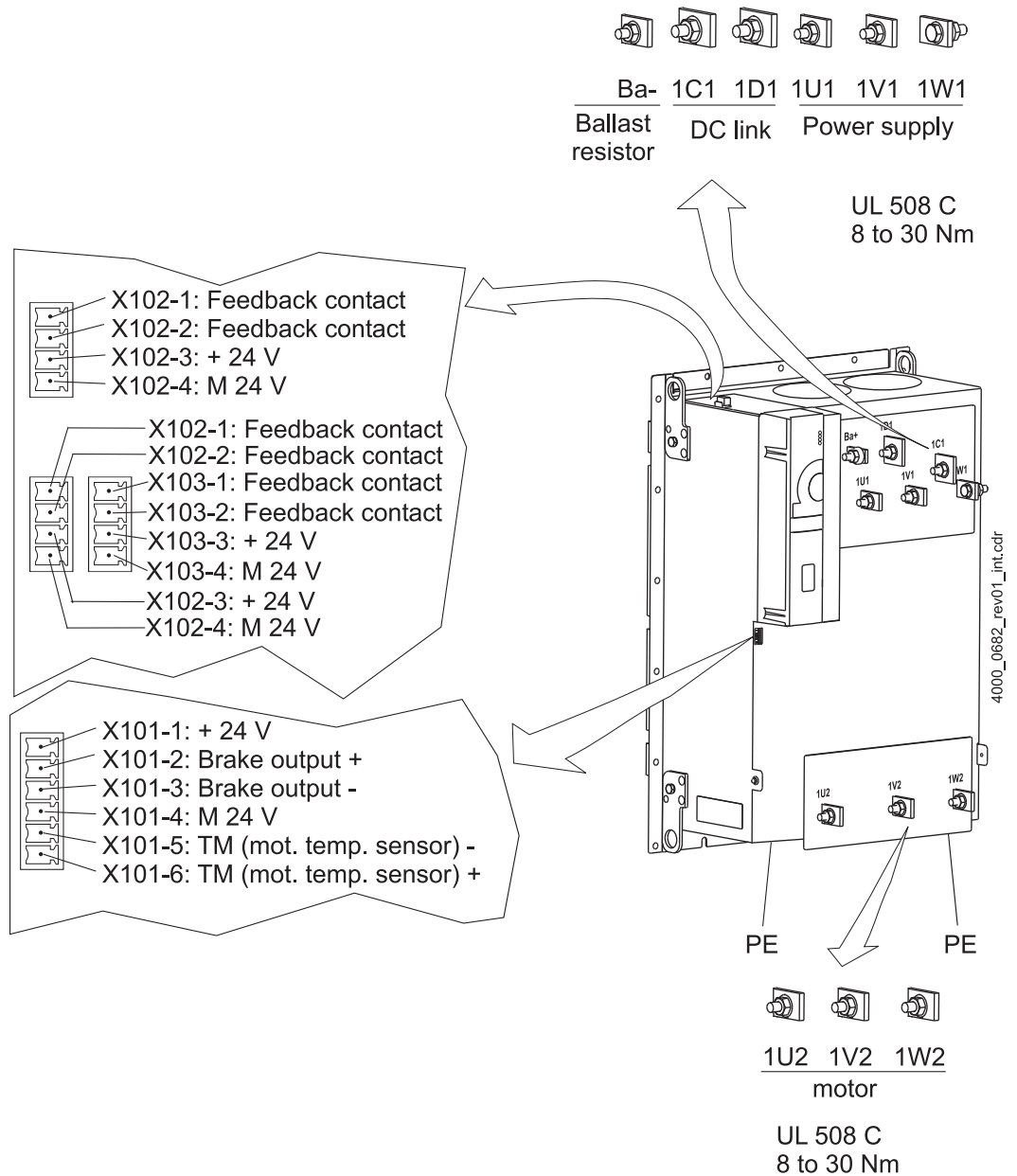

Figure 92: Electrical connections for power supply, motor, ... for BM466X and BM476X

7.11.2.8 Terminals BM4755

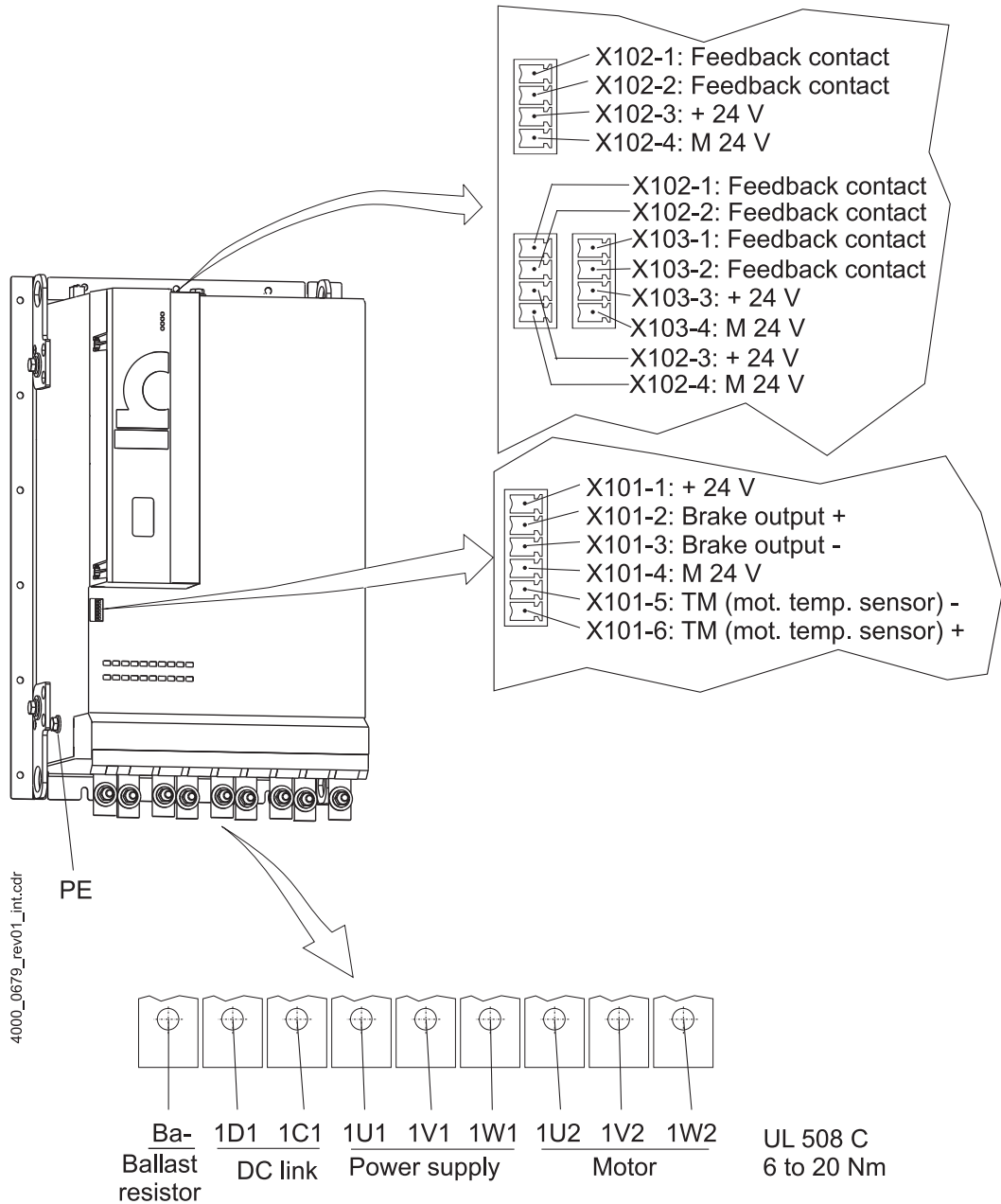
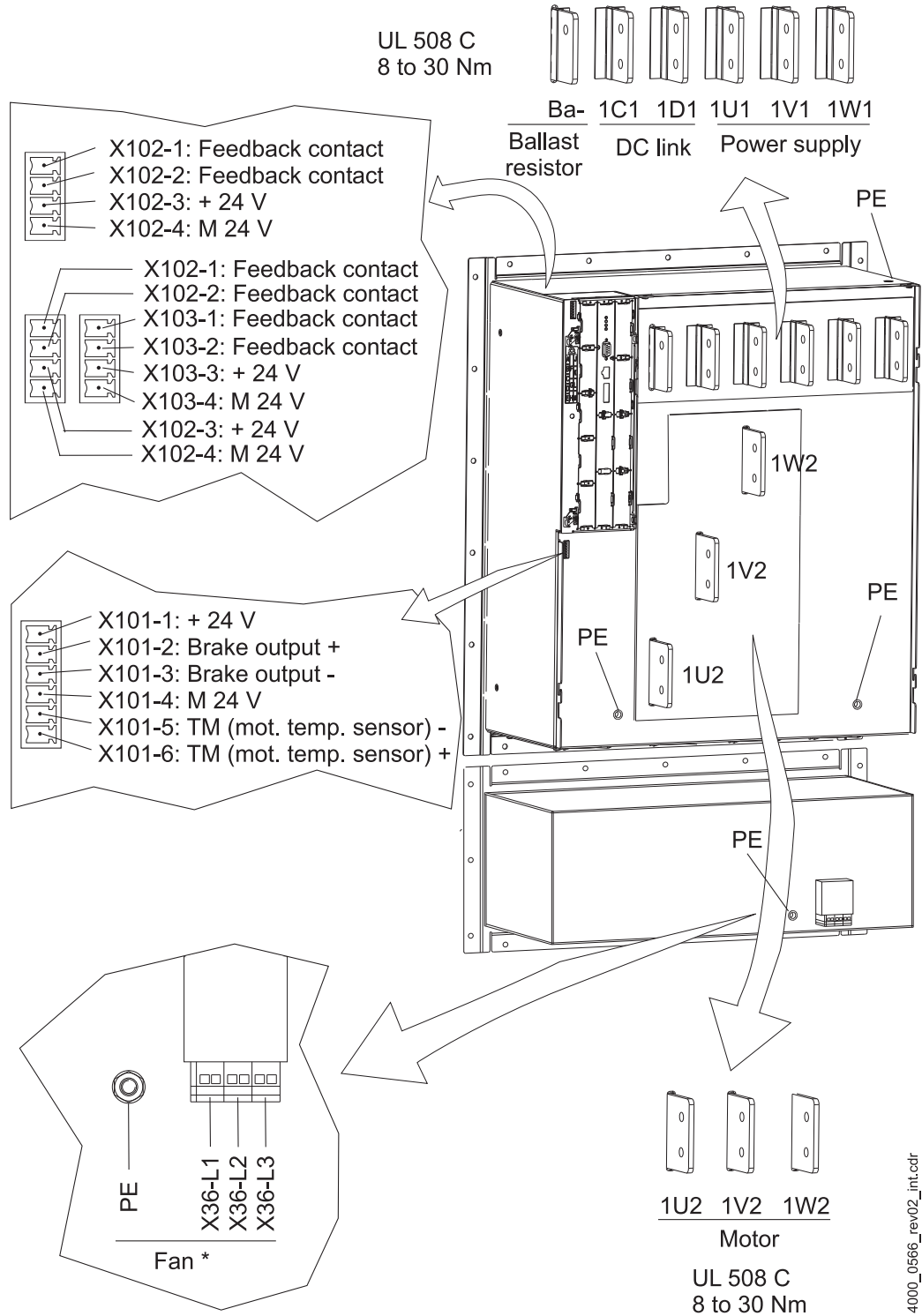

Figure 93: Electrical connections for power supply, motor, ... for BM4755

7.11.2.9 Terminals BM447X, BM4773



*) only BM447X-A

Figure 94: Electrical connections for power supply, motor, ... for BM447X and BM4773

**NOTE!**

The brake resistor is connected at the devices BM447X, BM477X between Ba- and 1C1. Also refer to [►Figure 81◀](#) on page 180.

**DANGER!****Risk of fatal injury from electrical current!**

Therefore:

After attaching all power cables to the device BM447X and BM477X, screw on the cover careful to all screwing points by using the enclosed screws (6xM4x12) and washers. The cover only must be able to be removed from the device with use of tools.

The use of semiconductor fuses is obligatory at the power supply connection of BM447X, BM477X devices. Semiconductor fuses are required in the brake resistor circuit except the user assures the short-circuit protection of resistor and cable.

7.11.3 Electrical connection power unit

Power system 1U1, 1V1, 1W1, PE	Max. cross-section of connection	Connection technology	Torque	Load capacity
BM441X	2.5 mm ²	Plug-in contact	-	Refer to Fuses from page 279
BM442X	4.0 mm ²	Screw terminal	Min. 0.5 Nm Max. 0.6 Nm	
BM443X Generation 1 ⁴⁾	10 mm ²	Screw terminal	Min. 1.2 Nm Max. 1.5 Nm	
BM443X Generation 2 ⁴⁾	25 mm ²	Screw terminal	Min. 2 Nm Max. 2.3 Nm	
BM463X				
BM444X BM464X	50 mm ²	Screw terminal	Min. 6 Nm Max. 8 Nm	
BM445X BM465X BM475X	2 x 95 mm ² ¹⁾³⁾	Cable lug for M8	Min. 10 Nm Max. 13 Nm	
BM446X BM466X BM476X	2 x 185 mm ² ²⁾³⁾	Cable lug for M10	Min. 12 Nm Max. 25 Nm	
BM447X BM477X	2 x 185 mm ² ²⁾ 4 x 95 mm ² ¹⁾	Cable lug for M10	Min. 12 Nm Max. 25 Nm	

not valid for
power modules

¹⁾ The cable lug may be 25 mm wide at most. The maximum cable diameter is dependent on the cable lug. In case the cable lug, which you use, can safely clamp a stronger cable than 95 mm², you may also use stronger cables than 95 mm². Also refer to [Cables power supply - device](#) from page 274.

²⁾ The cable lug may be 35 mm wide at most. The maximum cable diameter is dependent on the cable lug. In case the cable lug, which you use, can safely clamp a stronger cable than 185 mm², you may also use stronger cables than 185 mm². Also refer to [Cables power supply - device](#) from page 274.

³⁾ One cable of the mentioned cross section is sufficient for the operation.

⁴⁾ Refer to also [Explanation type code](#) on page 130.

**DC link
1C1 and 1D1²⁾
Ballast
Ba+ and Ba-¹⁾**

	Max. cross-section of connection	Connection technology	Torque	Load capacity 1C1 and 1D1 ²⁾ Ba+ and Ba- ³⁾
BM441X	2.5 mm ²	Plug-in contact	-	Refer to ►Electrical data of the universal units◄ from page 65
BM442X	4.0 mm ²	Screw terminal	Min. 0.5 Nm Max. 0.6 Nm	
BM443X Generation 1 ⁴⁾	10 mm ²	Screw terminal	Min. 1.2 Nm Max. 1.5 Nm	
BM443X Generation 2 ⁴⁾	25 mm ²	Screw terminal	Min. 2 Nm Max. 2.3 Nm	
BM463X				
BM444X BM464X	50 mm ²	Screw terminal	Min. 6 Nm Max. 8 Nm	
BM445X BM465X BM475X	2 x 95 mm ² 4)6)	Cable lug for M8	Min. 10 Nm Max. 13 Nm	
BM446X BM466X BM476X	2 x 185 mm ² 5)6)	Cable lug for M10	Min. 12 Nm Max. 25 Nm	
BM447X BM477X	2 x 185 mm ² 5)	Cable lug for M10	Min. 12 Nm Max. 25 Nm	

¹⁾ Not short-circuit-proof, consider maximum load! Refer to „Brake resistor external“ in chapter [►Technical Data◄](#) from page 33.

²⁾ Not short-circuit-proof, consider maximum load! Refer to „connected load DC link“ in chapter [►Technical Data◄](#) from page 33.

³⁾ Refer to „permitted brake resistor continuous power“ in chapter [►Technical Data◄](#) from page 33.

⁴⁾ The cable lug may be 25 mm wide at most. The maximum cable diameter is dependent on the cable lug. In case the cable lug, which you use, can safely clamp a stronger cable than 95 mm², you may also use stronger cables than 95 mm². Also refer to [►Cables power supply - device◄](#) from page 274.

⁵⁾ The cable lug may be 35 mm wide at most. The maximum cable diameter is dependent on the cable lug. In case the cable lug, which you use, can safely clamp a stronger cable than 185 mm², you may also use stronger cables than 185 mm². Also refer to [►Cables power supply - device◄](#) from page 274.

⁶⁾ One cable of the mentioned cross section is sufficient for the operation.

⁷⁾ Refer to also [►Explanation type code◄](#) on page 130.

7.11 Wiring diagrams

Motor 1U2, 1V2, 1W2, PE

	Max. cross-section of connection	Connection technology	Torque	Load capacity
BM441X	2.5 mm ²	Plug-in contact	-	Is limited by the device, also refer to ►Technical Data◄ from page 33
BM442X	4.0 mm ²	Screw terminal	Min. 0.5 Nm Max. 0.6 Nm	
BM443X BM463X	16 mm ²	Screw terminal	Min. 2 Nm Max. 2.3 Nm	
BM4443 BM4444 BM4641 BM4642	50 mm ²	Screw terminal	Min. 6 Nm Max. 8 Nm	
BM4445 BM4446	50 mm ²	Screw terminal	Min. 6 Nm Max. 8 Nm	
	95 mm ² ⁴⁾	Screw terminal	Min. 15 Nm ⁴⁾ Max. 20 Nm ⁴⁾	
BM445X BM465X BM475X	2 x 95 mm ² ¹⁾	Cable lug for M8	Min. 10 Nm Max. 13 Nm	
BM446X BM466X BM476X	2 x 185 mm ² ²⁾³⁾	Cable lug for M10	Min. 12 Nm Max. 25 Nm	
BM447X BM477X	2 x 185 mm ² ²⁾	Cable lug for M10	Min. 12 Nm Max. 25 Nm	
	4 x 95 mm ² ¹⁾			

¹⁾ The cable lug may be 25 mm wide at most. The maximum cable diameter is dependent on the cable lug. In case the cable lug, which you use, can safely clamp a stronger cable than 95 mm², you may also use stronger cables than 95 mm². Also refer to [►Cables power supply - device◄](#) from page 274.

²⁾ The cable lug may be 35 mm wide at most. The maximum cable diameter is dependent on the cable lug. In case the cable lug, which you use, can safely clamp a stronger cable than 185 mm², you may also use stronger cables than 185 mm². Also refer to [►Cables power supply - device◄](#) from page 274.

³⁾ One cable of the mentioned cross section is sufficient for the operation.

⁴⁾ After January 2018 delivery date: The devices provide connection terminals for larger cable cross-section.

Fan X36

	Max. cross-section of connection	Connection technology	Load
BM444X-S/-A BM464X-S/-A BM445X-S/-A BM465X-S/-A BM446X-S/-A BM466X-S/-A BM447X-A	4.0 mm ²	Spring Clip	Max. 1.0 A ¹⁾

¹⁾ For fuse protection a fuse with the tripping characteristic „delayed“ must be used.

X100 (SELV/PELV)	Max. cross-section of connection	Connection technology	Load capacity
24 V power supply	1.5 mm ²	Plug-in contact	X100-1, X100-2, X100-5 and X100-6: max. 8.0 A , if you consider UL508C: max. 4.0 A

X101 (SELV/PELV)	Max. cross-section of connection	Connection technology	Load capacity
Brake	BM441X BM442X	Plug-in contact	X101-1 bis X101-4: min. 0.1 A , max. 2.0 A
	BM4X3X BM4X4X BM4X5X BM4X6X BM4X7X	Plug-in contact	X101-1 bis X101-4: min. 0.1 A , max. 8.0 A if you consider UL508C: max. 4.0 A

X102 (option) Safety relay (SELV/PELV)	Max. cross-section of connection	Connection technology	Load capacity / voltage level
	1.5 mm ²	Plug-in contact	Refer to ►D.5 Technical data safety relay module◄ on page 374

Notes on the usage of an OSSD test pulse refer to [►D.4 Requirements on an OSSD test pulse◄](#) on page 373.

X103 (Option) Safety relay (SELV/PELV)	Max. cross-section of connection	Connection technology	Load capacity / voltage level
	1.5 mm ²	Plug-in contact	Refer to ►D.5 Technical data safety relay module◄ on page 374

Notes on the usage of an OSSD test pulse refer to [►D.4 Requirements on an OSSD test pulse◄](#) on page 373.

7.11.4 Requirements for the screwing



NOTE!

Follow the mentioned torques in [►Figure 91◄](#) on page 193 and in [►Figure 94◄](#) on page 196 to ensure an adequate conductivity.

7.12 Controller terminals



NOTE!

This Instruction Handbook describes the controller without function and option modules. A corresponding manual is available to each function/option module, refer to [►List of other applicable documents◀](#) on page 13.



HINWEIS!

- 1) If you consider UL508C, limit the current to 4 A.
- 2) Do not apply voltage to the terminals X100-3 or X100-4, if the device is not supplied via X100-1/2 with voltage.
The signals „mains on“ and „brake resistor“ are internal digital control signals of the system **b maXX 4000**. They are used at applications with DC link connection.
- 3) The PSI-module may not be attached or withdrawn, if the **b maXX 4000** 24 V power supply is ON. Beforehand switch off the device.
Further notes for the usage of the PSI module are to be found in parameter manual.
- 4) not BM44XX - XXX - XX0XX and BM44XX - XXX - XX1XX

Standard controller

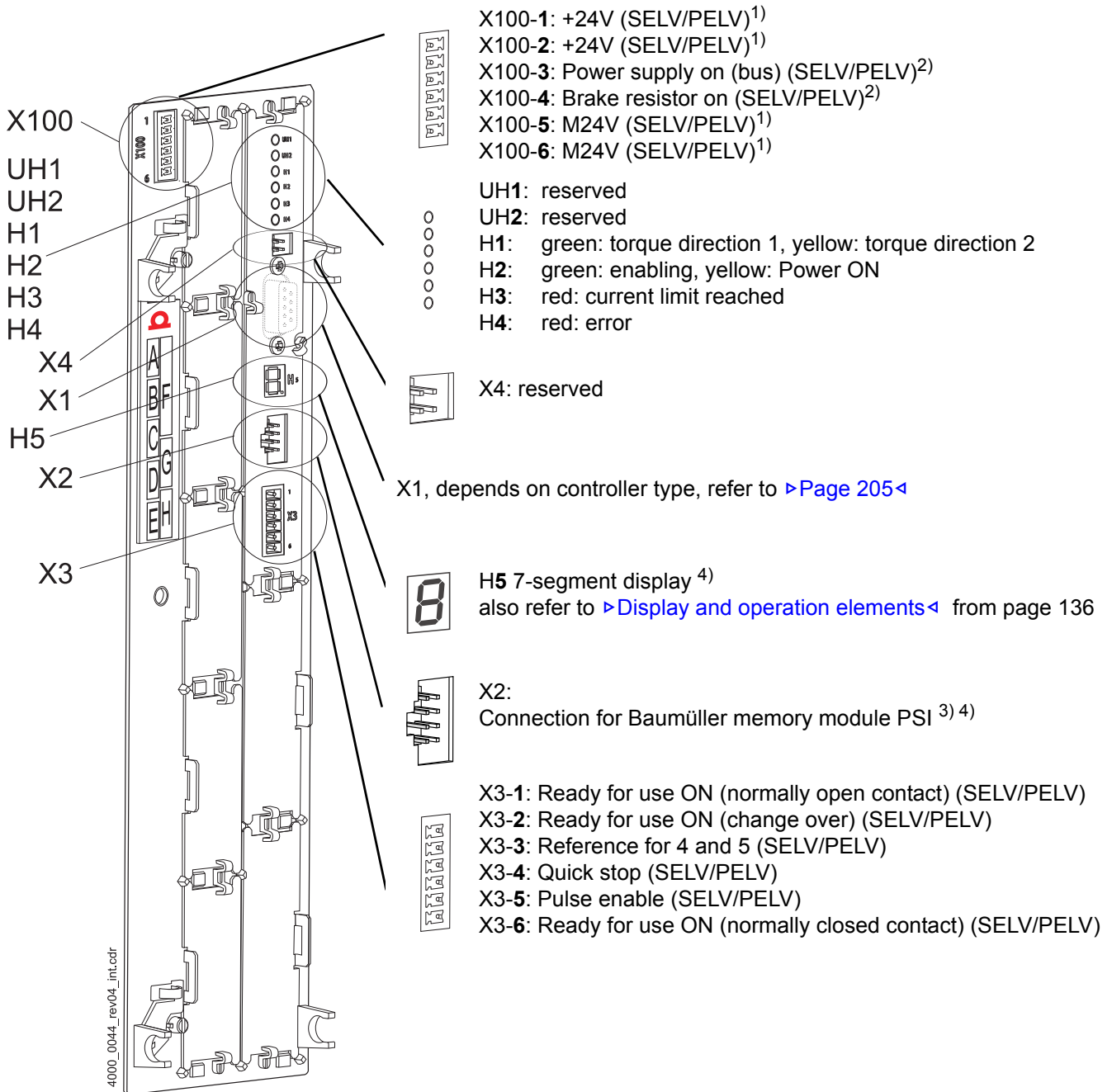
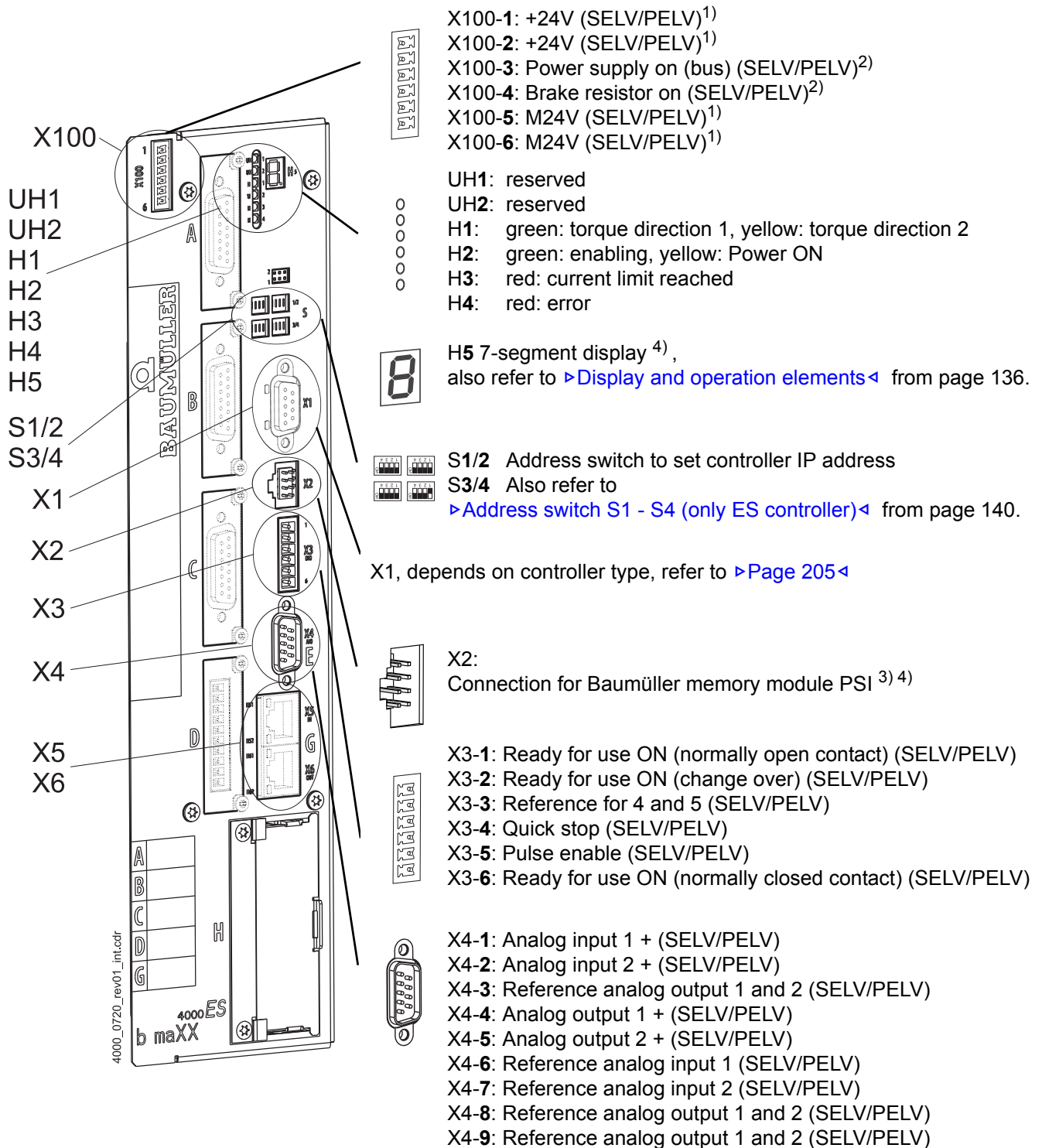

Figure 95: Connection X100 and terminals of a standard controller

ES controller



X1

depends on controller type

BM4XXX - XXX - XX0XX (with RS232-interface)
 BM4XXX - XXX - XX1XX (with RS232-interface)
 BM4XXX - XXX - XX2XX (with RS232-interface)

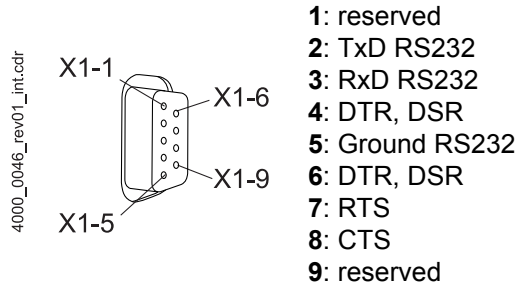

Recommended connection cable	Connection technology	Remark
LIYCY 6x2x0.14 mm ²	D-sub, 9-pin	Available as cable set: refer to ►Cable RS232◄ on page 310.



WARNING!

Risk of injury because of mechanical hazard!

If a PC is not connected via an isolated transformer, the machine can do unexpected actions.

Therefore:

Connect the PC via an isolated transformer or use a battery operated PC (e. g. laptop, notebook) without connecting a charger.



NOTE!

In case you don't use an optically decoupled interface cable, the cable shield has only to be connected to the connector housing at the controller connector.

The company Baumüller Nürnberg GmbH recommends the usage of optically decoupled transmitters (e.g. from the company Ratioplast part No. 901SV232C6095 and part No. 901SV232T6095)

Refer to [►Interface cable RS232◄](#) on page 278, if the cable is made by the customer.

BM4XXX - XXX - XX3XX[Ryy] - XX (with Ethernet interface)

X1

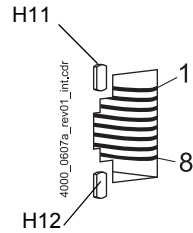

- 1: TX+
- 2: TX-
- 3: RX+
- 4: reserved
- 5: reserved
- 6: RX-
- 7: reserved
- 8: reserved

Name	Meaning
H11	Off: no activity
	Yellow: half duplex
	Green: full duplex
H12	Off: no connection
	Yellow: 10 Mbit
	Green: 100 Mbit

Ethernet cables are available as accessories (refer to [▶Accessories Ethernet/Ether-CAT®](#) on page 312).

X3 Ready for use ON (SELV/PELV)
Quick stop (SELV/PELV)
Pulse enable (SELV/PELV)

Max. cross-section of connection	Connection technology	Load capacity / voltage level
1.5 mm ²	Plug-in contact	Ready for use ON; X3-1, X3-2 and X3-6: Max. 0.2 A
		Quick stop; X3-4 Pulse enable; X3-5: 0 (low) 0 V to 5 V 1 (high) 12 V to 28 V

Notes on the usage of an OSSD test pulse refer to [►D.4 Requirements on an OSSD test pulse◄](#) on page 373.

X5/X6 depends on ES controller type

BM4XXX - XXX - XXXXX[Ryy] - **1X** (with EtherCAT® interface)

X5 IN

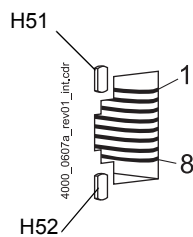

- 1: TX+
- 2: TX-
- 3: RX+
- 4: reserved
- 5: reserved
- 6: RX-
- 7: reserved
- 8: reserved

X6 OUT

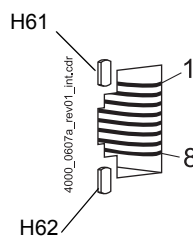

- 1: TX+
- 2: TX-
- 3: RX+
- 4: reserved
- 5: reserved
- 6: RX-
- 7: reserved
- 8: reserved



NOTE!

Setting the IP address, refer to [►EtherCAT®◄](#) from page 140.

Name	Meaning	Flashing pattern	
H51 (green)	X5 Link / Act	Off:	no connection
		On:	connection
		Flash:	data transmission
H52 (yellow)	ERROR	On:	ERROR (receiver error Phy1/Phy2)
H61 (green)	X6 Link / Act	Off:	no connection
		On:	connection
		Flash:	data transmission
H62 (yellow)	RUN	Off:	ERROR/INIT
		500 ms on/ 500 ms off:	PREOPERATIONAL
		200 ms on/ 1 s off:	SAFEOPERATIONAL
		On:	OPERATIONAL

Ethernet cables are available (refer to [▶ Accessories Ethernet/EtherCAT®](#) ◀ on page 312).

BM4XXX - XXX - XXXXX[Ryy] - 2X (with CANopen[®]-interface)

X5 IN

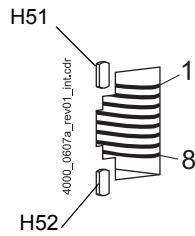

- 1: CAN high
- 2: CAN low
- 3: Ground (GND)
- 4: reserved
- 5: reserved
- 6: not connected
- 7: Ground (GND)
- 8: not connected

X6 OUT

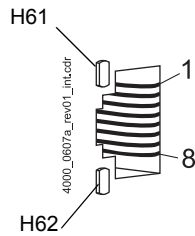

- 1: CAN high
- 2: CAN low
- 3: Ground (GND)
- 4: reserved
- 5: reserved
- 6: reserved
- 7: Ground (GND)
- 8: reserved

The LEDs have no function.



NOTE!

Setting the IP address, refer to [▶CANopen[®]◀](#) from page 143.

CAN cables are available (refer to [▶Accessories - CANopen[®]◀](#) on page 313).

7.12.1 Encoder connection slot/position A and B



NOTE

For further information refer to Instruction Handbook Encoder modules 5.01042.

- **BM4-F-ENC- 01, BM4-F-ENC-11, BM4-F-ENC-21; Resolver plug-in module**

Some encoders are listed in [►Encoder modules slot/position A and B◄](#) on page 127, pre-assembled encoder cables refer to [►Encoder cables◄](#) from page 314.

All encoders, which comply to the following technical specifications, may also be used:

Number of pole pairs	The ratio between the number of motor pole pairs and of the number of pole pairs of the encoder must be integer. ¹⁾	
Permitted current input	Max. 160 mA	
Excitation frequency	4 kHz	
Excitation current	160 mA	
Transmission ratio	BM4-F-ENC-01	0.5
	BM4-F-ENC-11	0.28



NOTE

Resolvers are to be used only for motors with maximum ten pole pairs.

Pin assignment

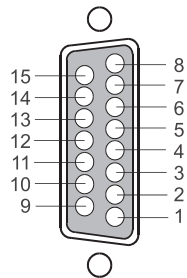

D-sub socket 15-pin

Pin no.	Pin assignment
1	Resolver ref -
2	Resolver ref +
3	Reserved
4	Reserved
5	Resolver COS +
6	Reserved
7	Resolver SIN +
8	Resolver SIN -
9	Resolver COS -
10	Reserved
11	Reserved
12	Reserved
13	Reserved
14	Temperature sensor + ²⁾
15	Temperature sensor - ²⁾

* do not assign

1) Example:

Number of pole pairs motor = 3
 Number of pole pairs resolver = 1

$$\frac{3}{1} = 3 \text{ permitted}$$

Number of pole pairs motor = 3
 Number of pole pairs resolver = 2

$$\frac{3}{2} = 1,5 \text{ not permitted}$$

2) Requirements to the temperature sensor:

Type	Additional requirements	Insulation
KTY84	-	SELV/PELV
NTC (MSKL)	R = 1KΩ at T _{protection} ; I _{max} < 2mA	SELV/PELV

- **BM4-F-ENC-02, BM4-F-ENC-12; Sine-cosine encoder module Hiperface®**

The sine-cosine encoder module provides a Hiperface® interface.

Some encoders are listed in [►Encoder modules slot/position A and B◄](#) on page 127, pre-assembled encoder cables refer to [►Encoder cables◄](#) from page 314.

All encoders, which comply to the following technical specifications, may also be used:

Power supply	8 V DC
Signal level	Hiperface® - specification of operation data channel (~1Vss; REFSIN/REFCOS 2.5V)
Permitted current input	Max. 250 mA

Pin assignment

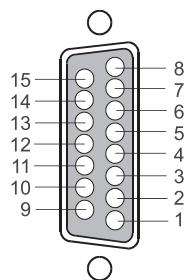

D-sub socket 15-pin

Pin no.	Pin assignment
1	GND encoder supply
2	+ 8V encoder supply
3	Reserved
4	Reserved
5	COS +
6	Reserved
7	SIN -
8	SIN +
9	COS -
10	Temperature sensor + ^{1) 2)}
11	Temperature sensor - ^{1) 2)}
12	RS485 +
13	Reserved
14	Reserved
15	RS485 -

* do not assign

1) Requirements to the temperature sensor:

Type	Additional requirements	Insulation
KTY84	-	SELV/PELV
NTC (MSKL)	$R = 1\text{ k}\Omega$ at $T_{\text{protection}}$, $I_{\text{max}} < 2\text{mA}$	SELV/PELV

2)



NOTE

At use of module in connection with pre-assembled Baumüller encoder cables the temperature sensor is not connected to the encoder cable!
You can connect the temperature sensor separately at the module (in the D-sub connector) or at the power unit.

• **BM4-F-ENC-03; 5 V square wave incremental encoder-plug-in module**

Some encoders are listed in [►Encoder modules slot/position A and B◄](#) on page 127, pre-assembled encoder cables refer to [►Encoder cables◄](#) from page 314.

All encoders, which comply to the following technical specifications, may also be used:

Power supply	5 V DC
Signal level	RS422 (TTL)
Permitted current input	Max. 250 mA

Pin assignment

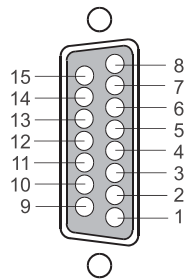

D-sub-Tube 15-pin

Pin no.	Pin assignment
1	GND encoder supply
2	+ 5V encoder supply
3	RS422 incremental encoder track +0
4	RS422 incremental encoder track -0
5	RS422 incremental encoder track +B
6	Reserved*
7	RS422 incremental encoder track -A
8	RS422 incremental encoder track +A
9	RS422 incremental encoder track -B
10	Reserved*
11	Reserved*
12	Sense + 5V encoder supply
13	Sense GND encoder supply
14	Reserved*
15	Reserved*

* do not assign

- **BM4-F-ENC-04; Sine-cosine encoder module with zero point sensing**

Some encoders are listed in [►Encoder modules slot/position A and B◄](#) on page 127, pre-assembled encoder cables refer to [►Encoder cables◄](#) from page 314.

All encoders, which comply to the following technical specifications, may also be used:

Power supply	8 V DC, stabilized to + 5 V at the encoder
Signal level	~1Vss
Permitted current input	Max. 250 mA (max. 300 mA)

Pin assignment

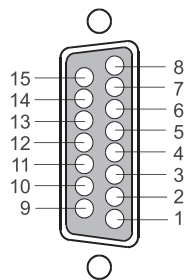

D-sub socket 15-pin

Pin no.	Pin assignment
1	GND encoder supply
2	+ 5V encoder supply
3	Zero point +
4	Zero point -
5	SIN + [B +]
6	Reserved*
7	COS - [A -]
8	COS + [A +]
9	SIN - [B -]
10	Reserved*
11	Reserved*
12	5 V Sense
13	0 V Sense
14	Reserved*
15	Reserved*

* do not assign



NOTE

A broken wire of the zero point cable is not detected by the controller.

• **BM4-F-ENC- 05; Sine-cosine encoder module EnDat® 2.1**

The sine-cosine encoder module is provided with a bidirectional, synchronous-serial EnDat® interface via the position data and parameters with a data rate of max. 2MBit/s are exchanged between control electronics and encoder.

Some encoders are listed in [►Encoder modules slot/position A and B◄](#) on page 127, pre-assembled encoder cables refer to [►Encoder cables◄](#) from page 314.

All encoders, which comply to the following technical specifications, may also be used:

Power supply	8 V DC, stabilized to + 5 V at the encoder
Signal level	~1V _{ss}
Permitted current input	Max. 250 mA

Pin assignment

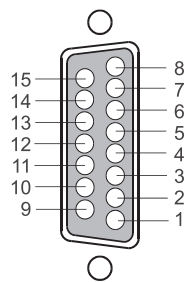

D-sub socket 15-pin

Pin no.	Pin assignment
1	GND encoder supply
2	+ 5V encoder supply
3	Temperature sensor + ¹⁾
4	Temperature sensor - ¹⁾
5	SIN + [B +]
6	Reserved
7	COS - [A -]
8	COS + [A +]
9	SIN - [B -]
10	Clock +
11	Clock -
12	5 V Sense
13	0 V Sense
14	Data +
15	Data-

* do not assign

¹⁾ Requirements to the temperature sensor:

Type	Additional requirements	Insulation
KTY84	-	SELV/PELV
NTC (MSKL)	R = 1 kΩ at T _{protection} , I _{max} < 2mA	SELV/PELV

- **BM4-F-ENC- 06; Encoder module EnDat[®] 2.2**

The encoder module is only provided with a bidirectional, synchronous-serial EnDat[®]-interface via the position data and parameters with a data rate of max. 8 MBit/s are exchanged between control electronics and encoder.

Some encoders are listed in [►Encoder modules slot/position A and B◄](#) on page 127.

All encoders, which comply to the following technical specifications, may also be used:

Power supply	8 V DC, stabilized to +5 V at the encoder
Permitted current input	Max. 250 mA

Pin assignment

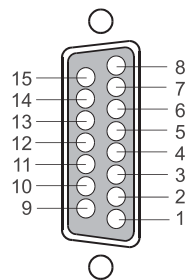

D-sub socket 15-pin

Pin no.	Pin assignment
1	Not assigned
2	GND encoder supply
3	Not assigned
4	+5 V encoder supply
5	DATA +
6	Not assigned
7	Not assigned
8	CLK +
9	Not assigned
10	GND encoder supply
11	Not assigned
12	+5 V encoder supply
13	DATA -
14	Not assigned
15	CLK -



NOTE

Encoder cable for EnDat[®] 2.2 without incremental signals (original encoder cable of Heidenhain), refer to [►Encoder cables◄](#) from page 314.

• **BM4-F-ENC- 07; Sine-cosine encoder module SSI without encoder supply**

The sine-cosine encoder module is provided with a synchronous-serial SSI standard interface via the position data and parameters with a data rate of max. 2 MBit/s are exchanged between control electronics and encoder.

All encoders are listed in [►Encoder modules slot/position A and B◄](#) on page 127. can be used:

Power supply	External encoder power supply
Signal level	~1 Vss

Pin assignment

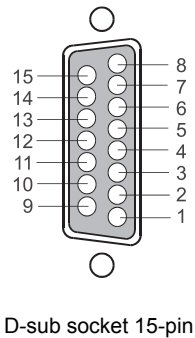

Pin no.	Pin assignment
1	Reserved*
2	Reserved*
3	Reserved*
4	Reserved*
5	SIN + [B +]
6	Reserved
7	COS - [A -]
8	COS + [A +]
9	SIN - [B -]
10	Clock +
11	Clock -
12	Reserved*
13	A_GND
14	Data +
15	Data-

* do not assign



NOTE

The connection cable is not offered by Baumüller and must be made by the user!

7.12 Controller terminals

Instruction:

- 1 Use the following materials:
 - Cable: LIYCY 5 x (2 x 0.14) + 2 x 0.5 mm², Cu braiding with at least 85 % opt. overlap
 - D-sub connector: 15-pin, male
 - Suitable encoder plug
- 2 Connect the cable shield with the cabinet of the circular connector and with the shield of the D-sub connector

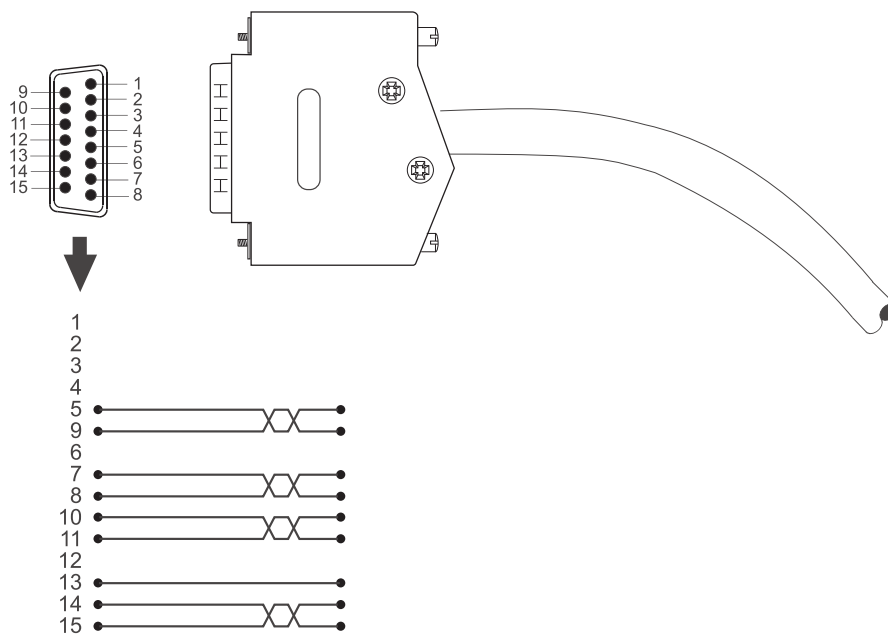

Figure 96: Connection cable BM4-F-ENC-07

• **BM4-F-ENC- 17; Sine-cosine encoder module SSI with 5 V encoder supply**

The sine-cosine encoder module is provided with a synchronous-serial SSI standard interface via the position data and parameters with a data rate of max. 2 MBit/s are exchanged between control electronics and encoder. All encoders, are listed in [►Encoder modules slot/position A and B◄](#) on page 127, may be used:

Power supply	8 V DC, stabilized to +5 V at the encoder
Signal level	~1 V _{ss}
Permitted current input	Max. 250 mA

Pin assignment

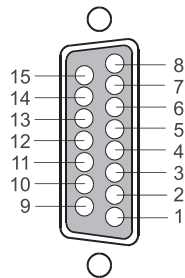

D-sub socket 15-pin

Pin no.	Pin assignment
1	GND encoder supply
2	+5 V encoder supply
3	Reserved*
4	Reserved*
5	SIN + [B +]
6	Reserved
7	COS - [A -]
8	COS + [A +]
9	SIN - [B -]
10	Clock +
11	Clock -
12	5 V Sense
13	0 V Sense
14	Data +
15	Data-

* do not assign



NOTE

The connection cable is not offered by Baumüller and must be made by the user!

7.12 Controller terminals

Instruction:

- 1 Use the following materials:
 - Cable: LIYCY 5 x (2 x 0.14) + 2 x 0.5 mm², Cu braiding with at least 85 % opt. overlap
 - D-sub connector. 15-pin, male
 - Suitable encoder plug
- 2 Connect the cable shield with the cabinet of the circular connector and with the shield of the D-sub connector



Abbildung 97: Connection cable BM4-F-ENC-17

• **BM4-F-ENC- 27; Encoder module SSI with 24 V encoder supply**

The encoder module is provided with a synchronous-serial SSI standard interface via the position data and parameters with a data rate of max. 1 MBit/s are exchanged between control electronics and encoder. All encoders, are listed in [Encoder modules slot/position A and B](#) on page 127, may be used:

Power supply	24 V DC, according encoder specification +0.5 V
Signal level	Differential
Permitted current input (encoder)	Max. 200 mA

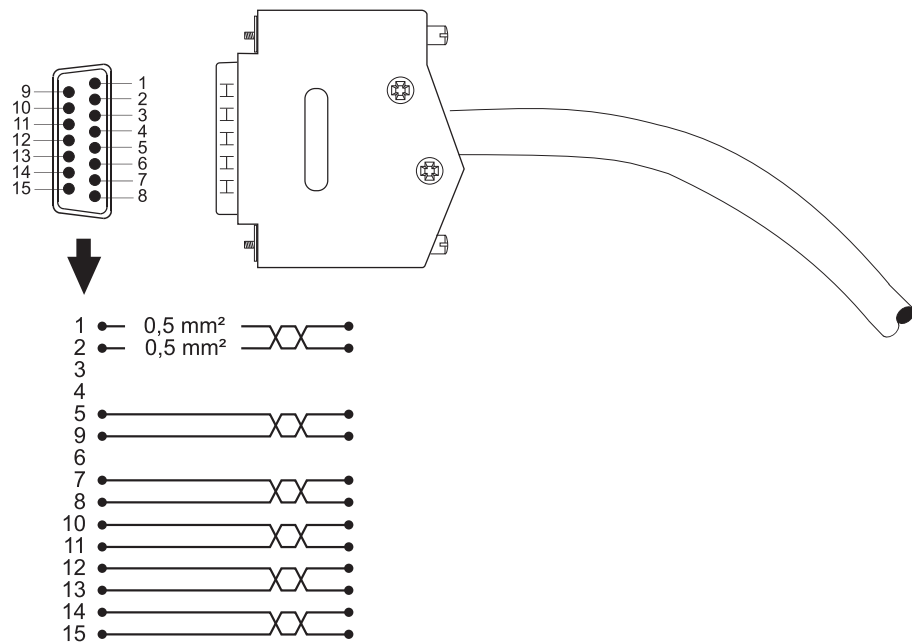
Pin assignment encoder supply

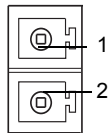

X1 Socket 2-pin

Pin no.	Pin assignment
1	+24 V DC
2	0 V

Pin assignment encoder

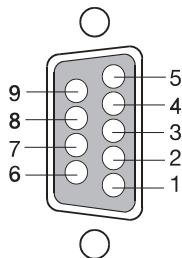

X2 D-sub socket 9-pin

Pin no.	Pin assignment
1	Data -
2	Data +
3	Reserved*
4	Reserved*
5	Reserved*
6	+24 V DC
7	0 V
8	Clock +
9	Clock -

* do not assign



NOTE

Only if the cable break monitoring is supported (refer to ProDrive, page „Slot identification“) and if the cable break monitoring is activated (refer to parameter handbook P0573) both cable break and missing of the 24V power supply and a cable break in Data+/Data- is identified. Otherwise the availability of the 24 V power supply is not checked and a broken cable is not detected by the controller.



NOTE

The connection cable is not offered by Baumüller and must be made by the user!

Instruction:

- 1 Use the following materials:
 - Cable: 6 leads (recommended: 2 x (2 x 0.14) + 2 x 0.5 mm², trunk cable in pairs and screened, tinned Cu braiding with at least 85% opt. overlap
 - D-sub connector. 9-pin, male
 - Suitable encoder plug, circular connector, 7-pin, female
- 2 Connect the cable shield with the cabinet of the circular connector and with the shield of the D-sub connector

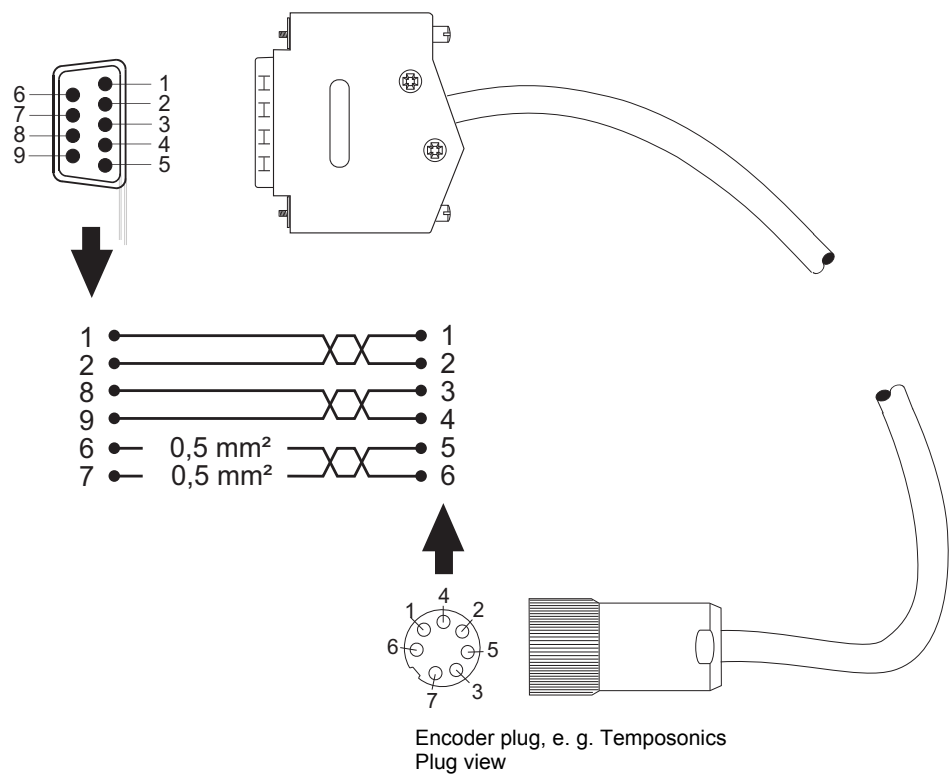

Figure 98: Connection cable BM4-F-ENC-27

- **BM4-F-ENC- 08; Sine-cosine encoder module with commutation**

To this encoder module you can connect sine-cosine encoders with sinusoidal commutation. Encoders are listed in [►Encoder modules slot/position A and B◀](#) on page 127. can be used:

Power supply	8 V DC, stabilized to + 5 V at the encoder
Signal level	Incremental encoder signals (A and B) ~1Vss Commutation signals (C and D) ~1Vss
Permitted current input	Max. 250 mA

Pin assignment

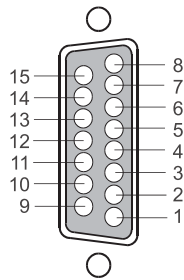

D-sub socket 15-pin

Pin no.	Pin assignment
1	GND encoder supply
2	+ 5 V encoder supply
3	Zero point + [R+]
4	Zero point - [R-]
5	COS + [A +]
6	Reserved*
7	SIN - [B -]
8	SIN + [B +]
9	COS - [A -]
10	D -
11	D +
12	5 V Sense
13	0 V Sense
14	C +
15	C -

* do not assign



NOTE

A broken wire of the reference signal cable [R+], [R-] or commutation signal cable [C+], [C-], [D+], [D-] is not detected by the controller



NOTE

The connection cable is not offered by Baumüller and must be made by the user!

7.12 Controller terminals

Instruction:

- 1 Use the following materials:
 - Cable: LIYCY 6 x (2 x 0.14) + 2 x 0.5 mm², Cu braiding with at least 85 % opt. overlap
 - D-sub connector. 15-pin, male
 - Suitable encoder plug
- 2 Connect the cable shield with the cabinet of the circular connector and with the shield of the D-sub connector



Abbildung 99: Connection cable BM4-F-ENC-08

7.12.2 Analog input slot/position D and E

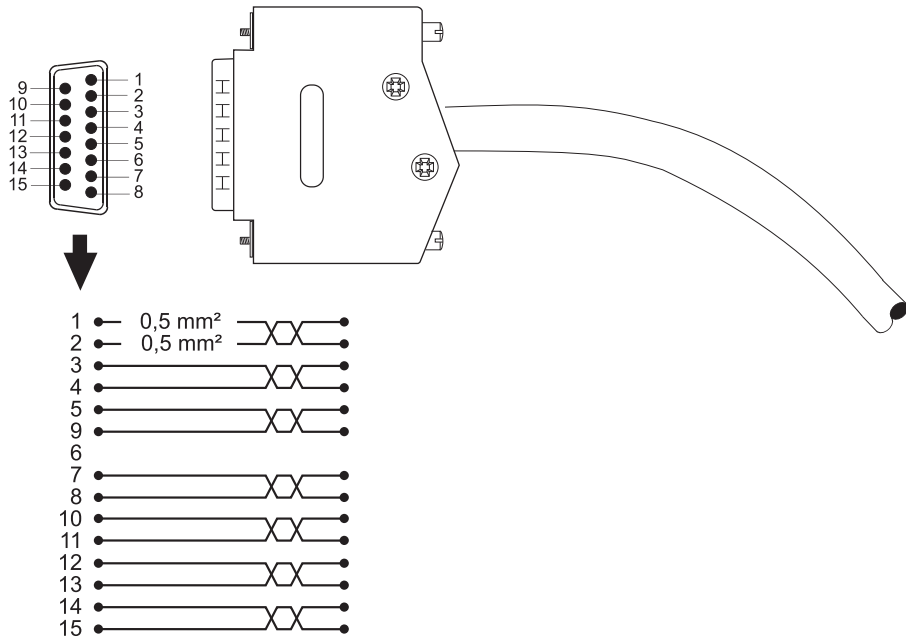

NOTE!

The module AIO-01 is always integrated in ES controller (position E, connector X4). The module AIO-02, 03 or 04 can be ordered at position D.

The module BM4-F-AIO-01 can be plugged in slot E in standard controller. The module BM4-F-AIO-02, 03 or 04 can be plugged in slot D or E.



NOTE!

Choose position E in ProDrive for configuration of analog inputs/outputs AIO-01 (connector X4) in ES controller.

Further information referring to analog inputs/outputs, refer to manual BM4-F-AIO-XX (5.01045).

Pin assignment

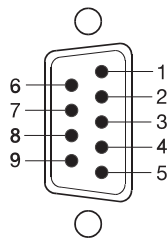

D-sub male terminal 9-pin

Pin No.	Pin assignment
1	IN 1 +
2	IN 2 +
3	OUT 1 -, OUT 2 -
4	OUT 1 +
5	OUT 2 +
6	IN 1 -
7	IN 2 -
8	OUT 1 -, OUT 2 -
9	OUT 1 -, OUT 2 -

Max. cross-section of connection	Connection technology
0.25 mm ²	D-sub female, 9-pin, metal type or metalized

7.12 Controller terminals

	BM4-F-AIO-			
	01	02	03	04
No of inputs	2			
No of I/O assignments input	2			
Resolution	10 bit / 12 bit	16 bit	12 bit	16 bit
Type	Differenzeingang			
Input resistance	ca. 50 k Ω			ca. 100 Ω
Max. input current	200 μ A			20 mA
Min. input current				4 mA
Sampling rate inputs, one input used	125 μ s			
Sampling rate inputs, both input used	250 μ s			
Analog input voltage	-10 V bis +10 V			2 V
No of outputs	2 ¹⁾			
No of I/O assignments output	2			
Max. output current	1 mA			
Resolution	8 bit	16 bit	12 bit	16 bit
Update rate fast outputs	125 μ s			
Update rate slow outputs	8 ms			
Short-circuit current capability output	limited short-circuit proof (max. 10 s)			
Analog output voltage	-10 V bis +10 V			

¹⁾ The analog output speed can be changed from „slow output“ to „fast output“ by the operation software and vice versa.

7.12.3 Digital inputs slot A to E/position D



NOTE!

The module DIO/FIO can be used **only** in position D of ES controller.

The module BM4-F-DIO/FIO can be used in all slots of the standard controller, but preferred should be slot D.



NOTE!

Further information referring to digital inputs/outputs, refer to manual **BM4-F-DIO/FIO** (5.01046).

Pin assignment

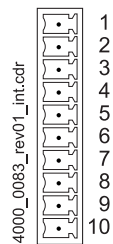

Multi-pin connector 10-pin

Pin No.	Pin assignment
1	IN 1
2	IN 2
3	IN 3
4	IN 4
5	OUT 1
6	OUT 2
7	OUT 3
8	OUT 4
9	+24 V
10	M 24 V

Max. cross-section of connection	Connection technology
1.5 mm ²	Connector, 10-pin



Figure 100: Skinning length

7.12 Controller terminals

	DIO-01 / DIO-11 ¹⁾	FIO-01 / FIO-11 ¹⁾
Power supply	24 V (19 to 28 V) ³⁾	
Current consumption (24 V)	2.0 A	
Current consumption (internal)	Max. 50 mA	
No. of inputs	4	
Evaluation inputs	Edges (2 inputs can be used for writing on one parameter)	
Number of I/O-linking groups input	4	
Max. input current	2 mA	5 mA
(Typical) transit time delay, input side	4 ms	10 µs
Digital input voltage	0 (LOW) = 0 to 5 V; 1 (HIGH) = 12 to 28 V	
Number of outputs	4	
Number of I/O-linking groups output	4	
Max. output current	0.5 A	
Resistance to short circuiting at outputs	Yes, limited by current with tripping ²⁾	

¹⁾ Unlike DIO/FIO-01 inside DIO/FIO-11 the contact „ground external“ is **not** connected to PE.

²⁾ On tripping, there appears an error message on the controller.

³⁾ Limit the current to 2.5 A. (Due to this also UL 508 C with a maximum current of 4 A will be considered).

OPERATION

8.1 Safety notes

Basic information

**WARNING!****Risk of injury due to improper operation!**

Improper operation can lead to severe personal injury or material damage.

Therefore:

- Perform all operational steps according to the details of these instruction handbook.
- Before beginning any work, ensure that all coverings and protective devices are installed and are functioning properly.
- The control cabinet in which the device is installed should be protected against contact with electrically live parts.
Keep all doors of the control cabinet closed during operation.

**NOTICE!****Environmental conditions that do not meet the requirements.**

Environmental conditions that are non-compliant can lead to property damage.

Therefore:

- Ensure that the environmental conditions are kept compliant during operation (refer to [►Required environmental conditions◄](#) on page 57).



WARNING!

Risk of injury due to insufficient qualifications!

Inevitably, when operating this electrical device, certain parts of this device are energized with hazardous voltage. Improper handling can lead to significant personal injury and material damage.

Therefore:

- Only qualified personnel may work on this device!

8.2 Operating concept

After the device has been commissioned it is parameterized (adapted to the application). Once parameterization has been completed, the device can be operated with one of the two following operation systems:

System 1

- Two enable signals (refer to [►Enable signals◄](#) on page 230) via digital inputs/outputs

System 2

- Two enable signals (refer to [►Enable signals◄](#) on page 230) via digital inputs/outputs
- Higher level control, which controls the two enable signals and in addition give commands via digital inputs/outputs and/or e.g. the field bus.

The operating software ProDrive is not necessary during operation.

The operating software ProDrive is only necessary, if an error occurs or if parameters have to be changed. In case of an error the service engineer can, with the help of ProDrive determine the error.

8.2.1 Enable signals

These signals must have a signal level of 24 V (DC) and must be connected to the terminals X3-4 and X3-5 ([►Figure 95◄](#) on page 203).

Pulse enable

During operation the signal „pulse enable“ must constantly be available, so that the device supplies power. Additionally the pulse enable has to be generated by the controller. Both signals are AND-linked, so the failure of one of these signals results in impulse inhibit of the power unit.

Quick stop

Disable the signal „quick stop“ only, if you must stop the installation/device as quick as possible.

During operation the signal „quick stop“ must be available, so that the device supplies power.

8.3 Power on switching frequency / DC link charging

8.3.1 Power supply switch-on frequency BM441X and BM442X

The devices use a rectifier with 6 diodes (B6U circuit). There is a resistor between rectifier and DC link capacitor limiting the charging surge. The resistor is bridged by a relay after the charging. Smaller waiting periods between the DC link discharge and charge reduce the lifetime of the devices. The specified waiting time of the device is increased to at least 90 seconds when an additional external DC link capacitance is connected. The maximum permitted external DC link capacitance depends on the power supply voltage (refer to [►Figure 33◄](#) on page 67 or [►Figure 35◄](#) on page 71).

8.3.2 Power supply switch-on frequency BM443X (generation 1)

Refer to [►Explanation version code◄](#) on page 134.

The devices use a rectifier with 3 diodes and 3 thyristors (B6HK circuit). From the voltage on the thyristors a sawtooth shaped voltage with power supply frequency is generated. This synchronous voltage is compared with a voltage decreasing from a start value to 0 V within ca. 10 seconds. If the current values of both voltages are equal, a thyristor is turned on and current flows from power supply to the DC link capacitor.

The maximum chargeable total capacity is limited by the power rating of the thyristors and diodes to 20 mF.

The thyristors are fired if the DC link charge is finished and a voltage drops in reverse direction on the thyristors.

When using the recommended fuses the rectifier is protected against overcurrent destruction.

When observing the limits of amplitude and frequency of power supply voltage and the value of the external capacity and the mounting of the recommended power choke the user ensures, that the input rectifier is operated in the permitted operating range.

The phase sequence, meaning clockwise rotating field or counterclockwise rotating field, is not relevant for charging the DC link and the operation of the device.

Below, the behavior described in the former paragraphs is characterized as „time-controlled charge procedure“.

8.3.3 Power supply switch-on frequency BM443X generation 2, BM4X4X to BM4X7X

• up to

BM 4 4 4 X - X X X - XXXXX[Ryy] - [XXX] - XX[xx] - **4005** -X-XXX-XXX
BM 4 4 5 X - X X X - XXXXX[Ryy] - [XXX] - XX[xx] - **5003** -X-XXX-XXX
BM 4 4 6 X - X X X - XXXXX[Ryy] - [XXX] - XX[xx] - **6003** -X-XXX-XXX
BM 4 4 7 X - X X X - XXXXX[Ryy]
BM 4 6 4 X - X X X - XXXXX[Ryy]
BM 4 6 5 X - X X X - XXXXX[Ryy]
BM 4 6 6 X - X X X - XXXXX[Ryy]
BM 4 7 X X - X X X - XXXXX[Ryy]

Above shown character string shows the type code on the type plate. The bold group of four strings (fifth segment of type code) determines the power unit's technical status. All devices with type to **4005**-, **-5003**- and **-6003**- use the before mentioned time-controlled charge procedure and behave similar to BM443X, but the charging time of the DC link is approximately 1 second.

Instead of the technical status shown directly on the type plate, the version of the power unit firmware can be shown in ProDrive (page power unit, top left, device data: firmware version). Up to version 03.06 [▶Power supply switch-on frequency BM443X \(generation 1\)◀](#) from page 231.

• from

BM 4 4 3 X - X X X - XXXXX[Ryy] - [XXX] - XX[xx] - **3006** -X-XXX-XXX
BM 4 4 4 X - X X X - XXXXX[Ryy] - [XXX] - XX[xx] - **4006** -X-XXX-XXX
BM 4 4 5 X - X X X - XXXXX[Ryy] - [XXX] - XX[xx] - **5004** -X-XXX-XXX
BM 4 4 6 X - X X X - XXXXX[Ryy] - [XXX] - XX[xx] - **6004** -X-XXX-XXX
BM 4 4 7 X - X X X - XXXXX[Ryy]
BM 4 6 3 2 - X X X - XXXXX[Ryy]
BM 4 6 4 X - X X X - XXXXX[Ryy]
BM 4 6 5 X - X X X - XXXXX[Ryy]
BM 4 6 6 X - X X X - XXXXX[Ryy]
BM 4 7 X X - X X X - XXXXX[Ryy]

For technical status higher than the above mentioned, an alternative procedure is implemented.

This version of the power unit firmware can be shown in ProDrive. It is 04.00 and higher.

The devices use a rectifier with 3 diodes and 3 thyristors (B6HK circuit). The circuit measures the voltage on the phase conductor and the DC link. The corresponding thyristor is fired, if the phase conductor voltage minus DC link voltage is lower than a fixed threshold. Thereby an almost constant voltage time area is applied to the series connection of phase conductor and DC link capacitor. The charge of the DC capacitor is done with current pulses of approx. same level. This level depends on the inductance of the commutation choke, the impedance of the power supply and the power supply voltage. The thyristors are fired, if the DC link is charged to 50 V difference between peak power supply voltage and DC link voltage and there is a potential drop in blocking direction. The thyristor shows a behavior like a diode.

8.3.4 Calculation of the maximum permitted external capacity

If a maximum allowable external capacity is specified in the technical characteristics, then it is either a device with diode rectification or one with the „old“ charge circuit (time controlled charging). If, however, it is referred on this chapter the maximum external DC link capacitance is calculated as followed prescribed.



HINWEIS!

Please check first if it is a device with the old charge circuit (refer to [►Page 232◄](#)). Should it be such a device of the sizes 3 to 6, then it is to consider that the maximum permitted capacity on the DC link (device internal capacity plus external capacity) has not to be larger than 20 mF.

The time for a charge sequence depends on the height of the charging current pulses and also the height of the internal and external capacity (refer to [►Table of charging times◄](#) on page 234). After 20 seconds the charging is discontinued.

For the charging function the device must be connected to a power supply with clockwise rotating field. No charging is started in case of counterclockwise rotating field. In rare cases a counterclockwise rotating field can cause an abrupt charging and a tripped fuse.

No charging is started at failure of one or two mains phases.

The external chargeable capacity is not limited because the height of the loading current of the DC link capacitor is approx. constant. But the time until the complete charge of the DC link is increased proportional to the capacity, that has to be charged. Error 089 („power unit not ready-to-operate“ is generated, if the charging is not finished after 20 s.

Example: BM4443 on 480 V.

From [►Table of charging times◄](#) on page 234 results a charge time of 0.4 s with the built in capacity of 1880 μ F.

$$\begin{aligned} \text{Maximum external capacity} &= \text{built in capacity} \cdot \left(\frac{20\text{s}}{\text{Charging time according table}} - 1 \right) \\ &= 1880\mu\text{F} \cdot \left(\frac{20\text{s}}{0.4\text{ s}} - 1 \right) = 92\text{mF} \end{aligned}$$

It is recommended to choose the external capacity 20 % lower, because the charging time can vary depending on the height of the power supply voltage.

8.3.5 Effects of the different charging circuits

Following incompatibilities result because of charging and must be checked by the user operating devices with the new current-controlled charging-method.

- Charging time: Adapt timeout values in master-control to avoid possible error messages because of not in time ready-to-operate signal.
- Ensure clockwise-rotating-field. The device does not identify the direction of the rotating field.

In case of a counter-clockwise-rotating-field no charging is done, after 20 s the attempt of charging is stopped and error 089 (power unit not ready-to-operate) is generated.

In rare cases a counterclockwise rotating field can cause an abrupt charging and a tripped fuse.

For error correction two power supply phases must be exchanged, e. g. the cables connected to 1U1 and 1V1. The error is corrected, assumed there is no other error.

The advantages of the current-controlled charging are (in short):

- The maximum chargeable DC link capacitance is higher than without the current-controlled charging.
- The dependency of the DC link capacitance on the charging current is reduced. The self-protection level of the device against incorrect dimensioning is improved.

8.3.6 Table of charging times

Device	Inductance power choke	Internal capacity	Typical charging time at 300 V	Typical charging time at 400 V	Typical charging time at 480 V	Typical charging time at 530 V
BM4632	0.19 mH	3000 µF	0.08 s	0.18 s	0.34 s	0.48 s
BM4443	0.36 mH	1880 µF	0.1 s	0.22 s	0.4 s	0.56 s
BM4444	0.26 mH	2350 µF	0.1 s	0.22 s	0.42 s	0.5 s
BM4445 BM4642	0.26 mH	3055 µF	0.11 s	0.26 s	0.47 s	0.65 s
BM4446	0.18 mH	3760 µF	0.09 s	0.22 s	0.4 s	0.57 s
BM4452	0.26 mH	3000 µF	0.11 s	0.25 s	0.47 s	0.66 s
BM4453	0.18 mH	3000 µF	0.08 s	0.18 s	0.32 s	0.45 s
BM4454 BM4652 BM4755	105 µH	6600 µF	0.1 s	0.24 s	0.4 s	0.58 s
BM4462	105 µH	6000 µF	0.09 s	0.22 s	0.38 s	0.52 s
BM4463	80 µH	6000 µF	0.07 s	0.16 s	0.29 s	0.4 s
BM4466 BM4766	80 µH	13.2 mF	0.14 s	0.33 s	0.61 s	0.86 s
BM447X	39 µH	19.8 mF	0.12 s	0.29 s	0.51 s	0.7 s
BM477X	32.6 µH	19.8 mF	0.1 s	0.24 s	0.4 s	0.58 s

TROUBLESHOOTING AND FAULT CORRECTION

9.1 Behavior in case of malfunctions

Basic information

**DANGER!****Risk of fatal injury from electrical current!**

Inevitably, when operating this electrical device, certain parts of it are energized with hazardous voltage.

Therefore:

- Pay heed to areas on the device that could be dangerous.

**WARNING!****Risk of injury due to improper fault correction!**

Therefore:

- Only qualified personnel may work on this device!
- Personnel that work with the **b maXX** device must be trained in the safety regulations and the handling of the device, and be familiar with the correct operation of it. In particular, reacting to error indications and conditions requires that the operator must have special knowledge.

9.2 Monitoring functions

A survey of the most important monitoring functions and the generated warning/error messages you will find in the following table. How to identify the error is explained in [Fault detection](#) from page 240.

Monitoring function	Warning/error	Warning	Error	Threshold adjustable	Reaction adjustable	Reaction	Adjusting of limit in parameters	Activation by parameter
Power supply voltage ⁶⁾	Power supply undervoltage	X	X	-	-	IS	-	-
	Power supply overvoltage	X	X	-	-	IS	-	-
Phase monitoring ⁶⁾	Phase failure	X	X	-	-	IS	-	-
	Power failure	X	X	X	-	IS ²⁾	P0486	P0486
Ground fault ¹⁾	Fault current to ground	-	X	-	-	IS	-	-
Overcurrent	Overcurrent motor	-	X	-	-	IS	-	-
DC link	DC link overvoltage	-	X	-	-	IS	-	-
	DC link undervoltage relative	X	-	-	-	-	-	-
Overload monitoring	Peak current not possible at the moment	X	-	-	-	-	-	-
Temperature heat sink	Temperature > threshold 1	X	-	X	-	-	P0018	-
	Temperature > shutdown threshold	-	X	-	-	IS	P0019	-
Temperature internal space	Temperature > threshold 1	X	-	X	-	-	P0016	-
	Temperature > shutdown threshold	-	X	-	-	IS	P0017	-
Temperature motor	I ² t-threshold exceeded	-	X	-	-	IS	P0073	P0093
	Threshold 1 exceeded ³⁾	X	-	X	-	-	P0088	P0093
	Threshold 2 exceeded ³⁾	X	-	X	-	-	P0089	P0093
	Short circuit sensor or temp. < -30 °C ³⁾	-	X	-	-	-	-	P0093
	Sensor not connected or temp. > 250 °C ³⁾	-	X	-	-	-	-	P0093
	Maximum temperature exceeded ³⁾	-	X	X	-	IS	P0090	P0093

¹⁾ Not available at BM441X and BM442X

²⁾ Pulse inhibit is generated after adjustable time period

³⁾ Only when using the KTY/PT1000 sensor

⁴⁾ Adjustable with P0299

⁵⁾ Adjustable with P0298

⁶⁾ Not available at power modules

IS: Pulse inhibit
SH: Quick stop
X: implemented
-: not possible

Monitoring function	Warning/error	Warning	Error	Threshold adjustable	Reaction adjustable	Reaction	Adjusting of limit in parameters	Activation by parameter
Position controller	Position deviation dynamic	-	X	X	-	SH	P1054	P1050
	Position deviation static	-	X	X	-	SH	P1055	P1050
Digital output	Short-circuit digital output	-	X	-	-	-	-	-
Controller synchronizing	Controller not synchronous with external signal	X	X	X	X	4)	P0533	P0299
Encoder 1	Cable break	-	X	-	-	IS	-	-
	Cable break ($\sin^2 + \cos^2$)	-	X	-	-	IS	-	-
	Overspeed	-	X	X	-	IS	P1072	-
Encoder 2	Cable break	-	X	-	-	IS	-	-
	Cable break ($\sin^2 + \cos^2$)	-	X	-	-	IS	-	-
	Overspeed	-	X	X	-	IS	P1082	-
Ramp-up option modules	Error at module initialization	-	X	X	-	IS	P0838	P0838
Cyclical set value transmission to the optional modules	Transmission timeout	-	X	X	X	5)	P0839	P0298
Safety relay	Supply voltage is missing or safety relay faulty	-	X	-	-	IS	-	-
	Safety relay - warning	X	-	-	-	-	-	-
Blocking monitoring	Drive blocked	-	X	X	-	IS	P1260	P1260

1) Not available at BM441X and BM442X

2) Pulse inhibit is generated after adjustable time period

3) Only when using the KTY/PT1000 sensor

4) Adjustable with P0299

5) Adjustable with P0298

6) Not available at power modules

IS: Pulse inhibit
SH: Quick stop
X: implemented
-: not possible

9.2 Monitoring functions

Power supply voltage	<p>- not available at power modules</p> <p>This monitoring function checks, if the power supply voltage has a value within the adjusted voltage range. If the value is lower, the warning „undervoltage power supply“ is generated. If the value is higher the warning „overvoltage power supply“ is generated.</p>
Phase monitoring	<p>- not available at power modules</p> <p>This monitoring function checks the three phases of the power supply voltage.</p> <p>If a phase is missing, the warning „phase failure“ is reported to the controller. The reaction time between the phase failure and the error message of the controller is max. 50 ms.</p> <p>If all three phases are missing the warning „power supply failure“ is reported to the controller. The reaction time between the power supply failure and the error message of the controller is max. 50 ms. After reaching the adjusted delay time of parameter P0486 the controller generates the error message „power supply failure“.</p>
Ground fault	<p>This monitoring function checks, if there is a short-circuit between the motor terminals and the ground. If a short-circuit is detected, there is immediately a pulse inhibit.</p> <p>This monitoring function doesn't exist by BM441X and BM442X.</p>
Overcurrent	<p>This monitoring function checks, if the motor current is greater than 1.3 x output peak current. It serves as „Disaster prevention“ in case of an output-sided short-circuit.</p>
DC link	<p>This monitoring function checks the voltage of the DC link. In case the voltage is below a value, which was internally specified (about 50 V under the set value), the warning DC link undervoltage is generated by the controller. In case the voltage exceeds an adjusted value about 820 V, the error „DC link overvoltage“ is signaled by the controller and the pulses are inhibited immediately.</p>
Overload monitoring	<p>This monitoring function checks the current calculated load thereupon, if the power unit can provide the peak current at the moment. In case the peak current is not possible, the message „Power unit overload“ is generated.</p>
Temperature device internal space	<p>This monitoring function checks the temperature in the internal space of the device.</p> <ul style="list-style-type: none">• In case the temperature is higher than the warning threshold, the controller generates a warning.• In case the temperature is too high, the pulses are inhibited immediately.
Temperature heat sink	<p>This monitoring function checks the temperature of the heat sink.</p> <ul style="list-style-type: none">• In case the temperature is higher than the warning threshold, the controller generates a warning.• In case the temperature is too high, the pulses are inhibited immediately.

Temperature motor	<p>This monitoring function checks the temperature of the motor. In case the I^2t threshold is exceeded, the error „I²t overload“ is generated by the controller.</p>
Only for KTY84 and PT1000 sensor	<p>If the set temperature threshold 1 is exceeded, then the warning „Temperature threshold 1 exceeded“ is generated by the controller.</p> <p>If the set temperature threshold 2 is exceeded, then the warning „Temperature threshold 2 exceeded“ is generated by the controller.</p> <p>If the temperature falls below the minimum measurable value, or if a short circuit occurs at the sensor, then the error message „Temperature sensor short circuit“ is generated.</p> <p>If the temperature exceeds the maximum measurable temperature, or if the sensor is not connected, then the error message „Temperature sensor not connected“ is generated by the controller.</p>
For all sensors	<p>If the threshold set (type-specific) in the temperature switch or in the sensor is exceeded, then the error message „Over temperature“ is generated by the controller and the pulses are inhibited immediately.</p>
Position controller	<p>This monitoring function checks the position deviation limit statical/dynamical. In case the position deviation error is statical/dynamical greater than the set position deviation error limit, there is an error message „position deviation error statical“ and „position deviation error dynamical“. After monitoring time (position deviation time), additionally an error message is generated and the pulses are inhibited immediately.</p>
Safety relay	<p>This monitoring function checks if the safety relay is ready and if the control voltage in order to activate the safety relay is connected. In case of an error the controller either generates an error or a warning, depending on, if the pulse enable is active or not.</p>
Blocking monitoring	<p>This monitoring function checks the motor speed and the motor current.</p> <p>If, for the period of time „blocking monitoring time“, the following two conditions are fulfilled, the error/warning „drive blocked“ is generated by the controller and the pulses are inhibited immediately.</p> <ul style="list-style-type: none"> • Motor speed = 0 • The motor current which is supplied by the device is equal to the set motor limit current (current limit).

9.3 Fault detection

The fault can be caused by mechanical or electrical malfunctions.

LED H4

The occurrence of an error state is signaled by the lighting up of the red LED H4 on the front side of the housing of **b maXX** 4000 devices.



NOTE!

If warnings or errors occur without error reaction the LED H4 „error“ *flashes*. Only error messages with error reaction are displayed *by constantly lighting up*.

7-segment display Additionally the error code is shown via the 7-segment display on the front side of the housing (not BM4XXX - XXX - XX0XX and BM4XXX - XXX - XX1XX).

By the displayed code the error message can be determined with help of [▶Error parameters, error messages, error reactions◀](#) from page 246. The displayed error is without exception an LEVEL 2 error (P0201 - P0216).

The display of an error code starts therewith, that „F“ is displayed for 1.5 s. Then the three characters of the error code are displayed. The separate characters are displayed for about 0.8 s, interrupted by a short break. If there are other errors, these are displayed in the same manner. The procedure is repeated as soon as all errors were displayed.

Example: Error 125 and 91 are generated:

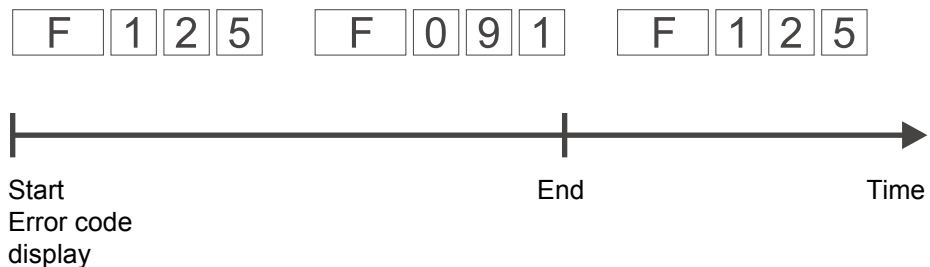

Figure 101: Error messages 7-segment display

Operating software ProDrive

Furthermore the error message is shown in the operating software:

- Start the operating program ProDrive (from FW 3.07), if it isn't running yet.



NOTE!

The controller software version and the operating software version must be compatible to use ProDrive with all functions.

In case the software version of the controller and the ProDrive version is not compatible, following message is displayed (also refer to online help ProDrive):

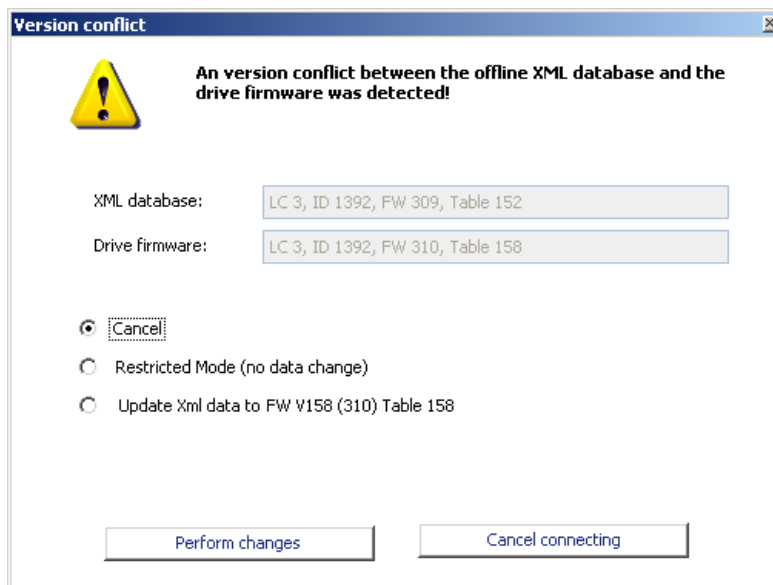

Figure 102: ProDrive version conflict



NOTE!

Please contact Baumüller Nürnberg GmbH or visit our website www.baumueller.com for download the latest version of ProDrive, if the controller software version is not available in your ProDrive version.

Start screen

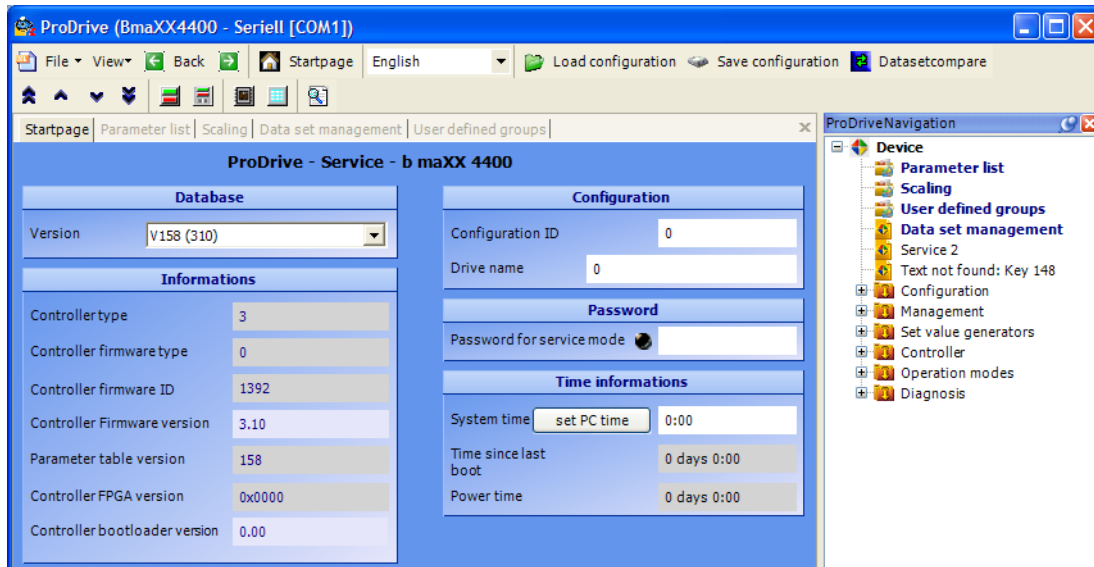

Figure 103: ProDrive start screen

Display the „error message“ in ProDrive.

- Open navigation with click on + in front of „Management“.

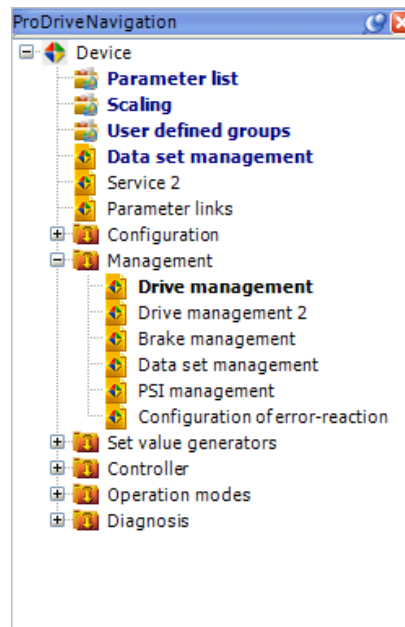

Figure 104: Project navigation in ProDrive

► Select „Drive management“

The window „Drive manager“ opens, refer to below with an exemplary (error) message. Before the communication between controller and PC/laptop is started, the messages in in this list have been arranged in numerical order. The newly occurring messages are added to the end of the list, when communication is active.

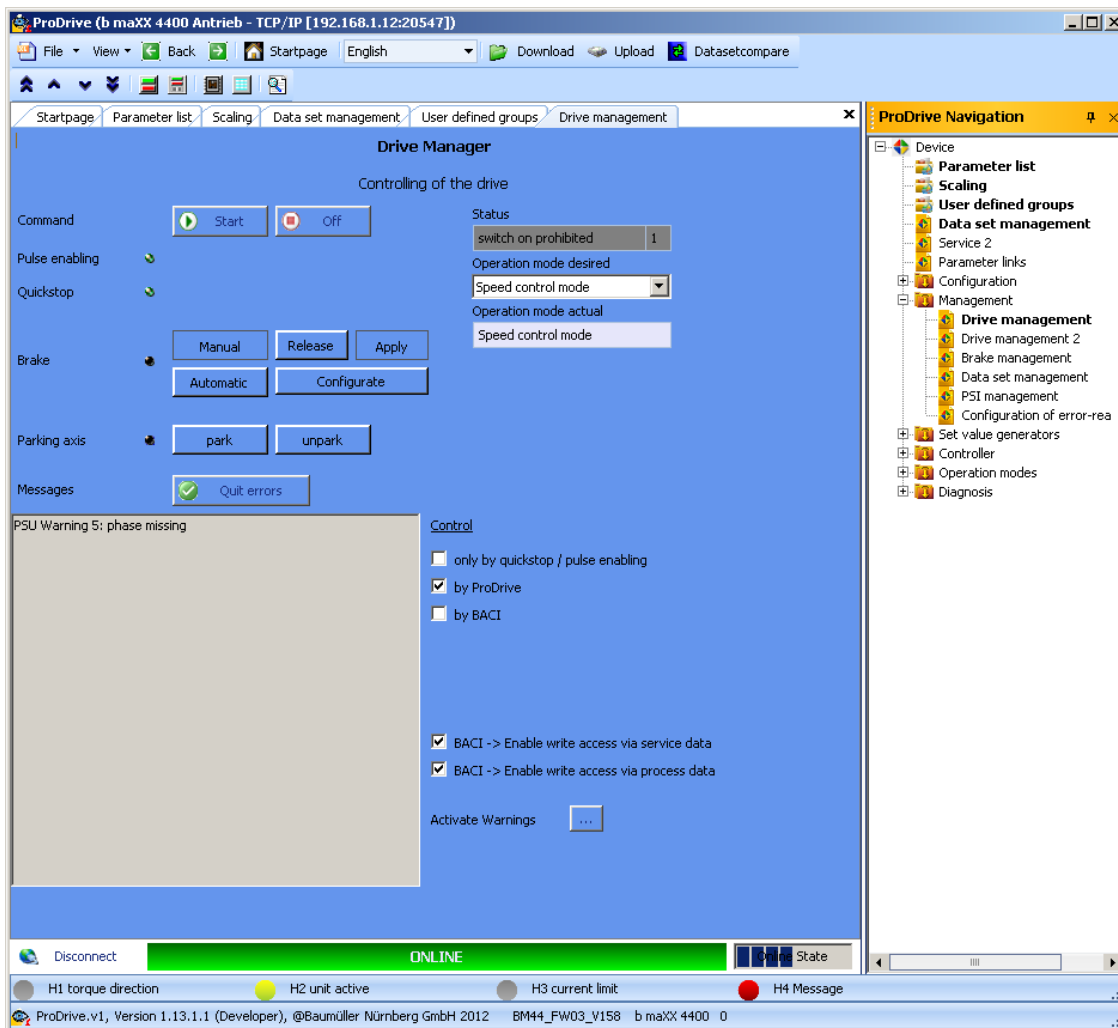

Figure 105: Drive manager ProDrive



NOTE

If you are not able to start the motor, although the red LED H4 is not lighting up and although the LED H2 is lighting up green, check the parameterization of the **b maXX 4000** with the parameter list in ProDrive.

Error possibilities are e. g.: torque limit = 0 has been set or notch position is not correct (also refer to parameter manual **b maXX 4000**).

If no LEDs are lighting up on the front side of the device, check the 24V supply.

9.4 Error handling

The error messages in the system are built up hierarchically

An error message can result from a beneath in the hierarchic arranged error message. This is why the message „Error“ (level 1) can base on an error, which e. g. has appeared in „Module error“ (level 2), because there is a failure in „Function module 1“ (level 3, e. g. SinCos-encoder module).

Error memory

From firmware 3.11 onwards an internal error memory exists to read out errors by a higher-level open-loop control. All occurrent errors which lead to an error response of the drive are saved chronologically in this error memory.

A read access to the error memory is done element by element with an index parameter (P0258) and a value parameter (P0259).

The error memory will be deleted completely at error acknowledgment (bit No.7 = 1 in control word).

For a further description refer to parameter P0257 in the parameter manual b maXX 4000.

Error display

If an error appears, the according definite error message is displayed within a short time in ProDrive in the menu „device manager“ and on the 7-segment display.



NOTE!

The device is provided with predefined error reactions. You are able to set the error reaction of the device in „Depending on settings“ in the column „Reaction“ marked error messages. An exception here are errors, which have to have an immediate pulse inhibit as a consequence. These can not be changed due to safety reasons.

9.4.1 Error reset

If the red error LED is lighting up, there is at least one error.

There are several methods to reset errors:

- Via ProDrive (from FW 3.07):
Button „Quit errors“ (either in the dialog box „Device manager“ or on the page “Device manager”).
That means, that you inform the device, that you have noted the error, that you have removed it or that you want to pass over it. Due to error reset all error messages are reset. An individual error reset is not possible. The button Quit errors causes a resetting of the error, in case the cause for the error message exists no longer.

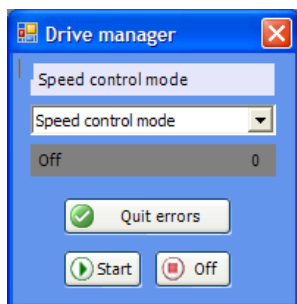

Figure 106: ProDrive Drive manager

- Via writing access to control word (P0300):
Here a rising edge must be generated in bit 7 (generated by the control system or by operating software via input to parameter list).
Note: The drive control must be active (refer to parameter P1001 Communication source) for the selected communication source.
- Via a digital input:
A digital input of a DIO module can be selected via parameter P0575 digital input for error acknowledgment can be selected for error reset. A rising edge on this input resets the error messages.
- Via the pulse enable input:
Precondition is, that the drive is only controlled via the hardware inputs (that means that the motor guide is neither set via the operating software nor via another communication source). Furthermore the option “Quit error via pulse enable” in parameter P1002 Options device manager must be active. With the first rising edge of pulse enable the errors then are reset. But the drive still does not start. Therefore you then need a second rising edge for the enable.

Additional data according the subject resetting of error messages is available in the „parameter manual“.

9.4.2 Error parameters, error messages, error reactions

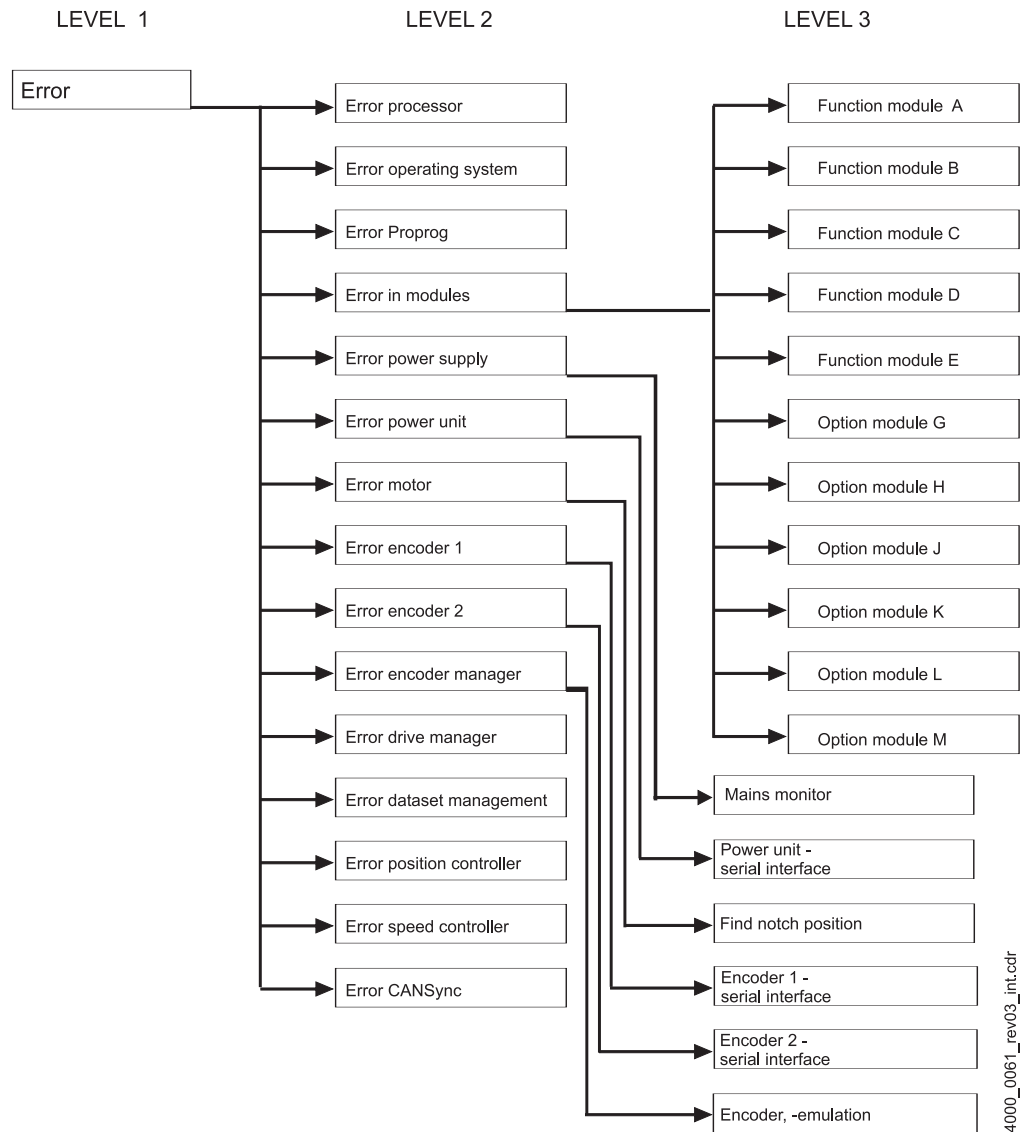

Figure 107: Survey error list

4000_0061_rev03_int.cdr

- 1st level** 1st level errors are only interesting for the access to errors via parameters, to be used without ProDrive, e. g. at Field bus communication. This errors are not shown in ProDrive/ 7-segment display.
- Bit mapping refer to description of the parameter P0200 in the parameter manual.
- 2nd level** Order of the error messages refer to survey ([▶Figure 107◀](#) on page 246).
- 3rd level** 2nd level error messages are displayed on the 7-segment display in ProDrive.



NOTE!

3rd level errors are only displayed in ProDrive separated by a decimal point from the corresponding 2nd level error.

e.g.:

Motor error 102: Group error find notch position **(2nd level)**

Find notch position error 102.64: Drive moved more than 4 times delta angle. **(3rd level)**

9.4.2.1 Error messages (2nd level)

In the column „Reaction“ the reaction of the system to the error is shown:

- „IS“ = pulse inhibit;
- „adjustable“ = the error reaction can be set via ProDrive (Window „Drive management“, toolbar button „Error reaction“).
- „no reaction“ means, the drive is continuing to work and the red error LED is blinking.

P0201 Error processor

Error No.	Meaning	Reaction	Troubleshooting
0	Reserved		
1	Watchdog error	IS	Restart b maXX 4000
2	Incorrect or unexpected interrupt has occurred	IS	
3	NMI Interrupt / bus error	IS	
4 to 15	Reserved, not assigned = 0		

9.4 Error handling

P0202 Error operating system

Error No.	Meaning	Reaction	Troubleshooting
16	Boot error	IS	Restart b maXX
17	Software error	IS	
18	Time slot configuration	IS	
19	Time slot - time error	IS	Restart b maXX ; Change configuration of the time slice operation system
20	1 = no free memory	IS	Restart b maXX
21	Invalid error code	IS	
22	Invalid warning code	IS	
23	Incorrect FPGA version	IS	Contact Baumüller Nürnberg GmbH
24	Two-state controller: error while writing to target parameter	IS	Ensure that the target parameter is writable in these operating conditions and the value to write is in the valid value range.
25	Checksum error flash system data	IS	The system data in the controller flash is invalid and was replaced by default values. These default values are written to the flash by switching off and on.
26	Power unit is not supported	IS	Use an appropriate power unit or contact Baumüller Nürnberg GmbH
27 to 31	Reserved, not assigned = 0		

P203 Error Proprog communication

Error No.	Meaning	Reaction	Troubleshooting
32	Timeout protocol	adjustable	Restart b maXX 4000
33	Protocol structure	adjustable	
34	Wrong module type	adjustable	Contact Baumüller Nürnberg GmbH
35	Too many data in the telegram	adjustable	
36	Not enough data in telegram	adjustable	
37	Invalid operand	adjustable	
38	Invalid memory type	adjustable	Test RAM
39	Invalid operand address	adjustable	Enter valid address
40	Value less than the minimum value	adjustable	Check and adjust data set
41	Value greater than the maximum value	adjustable	
42	Parameter is write-protected	adjustable	
43	Parameters in this operation state not writable	adjustable	Check operating condition and parameterization
44	Invalid parameter value	adjustable	Enter with a valid value
45	Communication error ProDrive ↔ controller	adjustable	Establish connection again or set parameter P0290 to 0.
46 to 47	Reserved, not assigned = 0		

P0204 Error in function or option modules

Error No.	Meaning	Reaction	Troubleshooting
48	Error in function module A	3rd level error	refer to ►Error in function module A to E◄ on page 261 (= 3rd level)
49	Error in function module B		
50	Error in function module C		
51	Error in function module D		
52	Error in function module E		
53	Error in option module G		
54	Error in option module H		
55	Error in option module J		
56	Error in option module K		
57	Error in option module L		
58	Error in option module M		
59	Timeout when waiting for the RST signal of the slaves	IS	Restart b maXX 4000
60	CRC error in SPI transmission Module ► controller	adjustable	Error indicates high EMC interferences; please reduce these. Contact Baumüller Nürnberg GmbH.
61	CRC error in SPI transmission Controller ► module	adjustable	
62 to 63	Reserved, not assigned = 0		

P0205 Error power supply

Error No.	Meaning	Reaction	Troubleshooting
64	Power supply failure	adjustable	Connect the power supply system
65	Phase failure	IS	Check if all phases are correctly connected and voltage-carrying
66	Undervoltage power supply, BM4100 only	IS	Assure the compliance with the power supply specifications (refer to ►Requirements to the energy supply / supply system◄ on page 54)
67	Overvoltage power supply, M4100 only	IS	
68	Undervoltage 24 V	IS	
69 to 78	Reserved, not assigned = 0		
79	Power supply monitor - group error	adjustable	Refer to ►Error power supply monitor◄ on page 259 (= 3rd level)

9.4 Error handling

P0206 Error power unit

Error No.	Meaning	Reaction	Troubleshooting
80	Communication error according Hiperface®-specification	IS	refer to ►Error power unit - serial interface◄ on page 256 (= 3rd level)
81	Heat sink temperature	IS	Let the device cool down and/or reduce the load
82	Overvoltage Uz _k	IS	Reduce the DC link voltage
83	Overcurrent	IS	Reduce the load and check the current controller settings as well as the cabling and the motor
84	Ground current	IS	Check installation of the device (from b maXX BM443X) and check the motor for ground fault
85	Device internal temperature too high	IS	Make sure of a sufficient ventilation in the device and/or check the temperature of cooling air
86	Cable break internal temperature sensor or internal temperature < 5 °C	IS	Make sure the environmental temperature (or heat sink temperature of the device) is ≥ 5 °C. If the error occurs even at a heat sink temperature ≥ 5 °C pass on the device for repair
87	Safety relay off (or defect)	IS	Check safety relay, change on request
88	Bridge short-circuit	IS	Restart b maXX 4000. At recurring error messages exchange the controller
89	Power unit not ready-to-operate	IS	Make sure that the power unit is ready-to-operate. Check the rotating field of the power supply
90	Up to FW 03.08 phase failure From FW 03.09 reserved	IS	Check the correct connection and voltage level of all phases
91	Power supply failure From FW 03.09 reserved	IS	Make power supply available.
92	Power supply undervoltage	IS	Assure the compliance with the power supply specifications (refer to ►Requirements to the energy supply / supply system◄ on page 54)
93	Power supply overvoltage	IS	
94	Undervoltage U _{DC} link	IS	Check power connections
95	Reserved, not assigned = 0		

P0207 Error motor

Error No.	Meaning	Reaction	Troubleshooting
96	Short-circuit temperature sensor (T _M ≤ -30 °C)	adjustable	Remove the short-circuit in the temperature sensor
97	Temperature sensor - motor not connected (T _M > +300 °C)	adjustable	Remove open circuit in the temperature sensor circuit
98	Motor overtemperature	IS	Remove motor overtemperature by cooling down and/or reducing the load
99	Error I ² t > 100 %	IS	Let the drive in a inhibited status until I ² t-actual value decreases under 100 %
100	Power unit maximal current > motor maximal current	adjustable	Set power unit maximal current P1241 lower than motor maximal current P0069
101	Reserved, not assigned = 0		
102	Group error find notch position	IS	Refer to ►Error at finding notch position◄ on page 260
103 to 111	Reserved, not assigned = 0		

P0208 Error encoder 1

Error No.	Meaning	Reaction	Troubleshooting
112	Communication error encoder 1	IS	Refer to ►Error encoder 1 - serial interface Error encoder 2 - serial interface on page 257
113	Reserved		
114	Error at overwriting of encoder position information	IS	Execute the command again. If the error occurs again, contact Baumüller Nürnberg GmbH.
115	Cable break encoder 1	IS	Remove the cable break in the encoder cable of encoder 1 or check the assignment of encoder cable
116	Overspeed encoder 1	IS	Check the allowable rotational speed for encoder 1
117	Amplitude limit exceeded	IS	Check the encoder cable and the encoder function. Use a different encoder
118	Encoder type unknown	IS	Check if the correct encoder is connected or use another encoder
119	Invalid data field for motor data	IS	Use another encoder
120	Incorrect motor data	IS	
121	Saving error of motor data	IS	
122	Motor data write-protected	IS	
123	Field angle error	IS	Check the shielding of the encoder cable
124	Encoder without temperature measuring	adjustable	Use an encoder module with temperature sensor
125	Memory capacity in the encoder for electronic type plate too small	adjustable	Use another encoder with a greater memory
126 to 127	Reserved, not assigned = 0		

P0209 Error encoder 2

Error No.	Meaning	Reaction	Troubleshooting
128	Communication error encoder 2	IS	Refer to ►Error encoder 1 - serial interface Error encoder 2 - serial interface on page 257
129	Reserved		
130	Error at overwriting of encoder position information	IS	Execute the command again. If the error occurs again, contact Baumüller Nürnberg GmbH.
131	Cable break encoder 2	IS	Remove the cable break in the encoder cable of encoder 2 or check the assignment of encoder cable
132	Overspeed encoder 2	IS	Check the allowable rotational speed for encoder 2
133	Amplitude limit exceeded	IS	Check the encoder cable and the encoder function. Use a different encoder
134	Encoder type unknown	IS	Check if the correct encoder is connected or use another encoder
135	Invalid data field for motor data	IS	Use another encoder
136	Incorrect motor data	IS	
137	Saving error of motor data	IS	
138	Motor data write-protected	IS	
139	Field angle error	IS	Check the shielding of the encoder cable
140	Encoder without temperature measuring	adjustable	Use an encoder module with temperature sensor
141	Memory capacity in the encoder for electronic type plate too small	adjustable	Use another encoder with a greater memory
142 to 143	Reserved, not assigned = 0		

P0210 Error encoder manager

Error No.	Meaning	Reaction	Troubleshooting
144	Absolute position of encoder 1 unknown	IS	Use a different encoder If error occurs at sine incremental encoder, set P0150 bit 9 = 1 (error message „absolute position of encoder 1 unknown“ is eliminated)
145	Absolute position of encoder 2 unknown	IS	
146	Encoder module 1 not available	IS	Check if the correct encoder is connected to slot A
147	Encoder module 2 not available	IS	Check if the correct encoder is connected to slot B
148	Encoder module for measured value storage not available	IS	Install the encoder module
149	When using a resolver no measured value storage possible	IS	Use a SinCos- or incremental encoder
150	Triggering not possible, no incremental encoder	IS	Use for this option an incremental encoder
151	Digital I/O module not available	IS	Install the digital I/O module
152	Incremental encoder emulation is require but not available	IS	Install the incremental encoder emulation module
153	Encoder module 1 is required for incremental encoder emulation but not available	IS	Install the encoder module on slot A
154	Encoder module 2 is required for incremental encoder emulation but not available	IS	Install encoder module on slot B
155	Initialization error of the incremental encoder emulation module	IS	Restart b maXX 4000
156	Incremental encoder emulation module hardware signal error	IS	Restart b maXX 4000 , exchange the module at repetitive error messages
157	Error incremental encoder emulation module	IS	Use for this option an incremental encoder
158	SSI encoder emulation module is not available	IS	Install SSI encoder emulation module
159	Error in set value source encoder 1 or encoder 2	IS	Refer to error messages encoder 1 or 2

P0211 Error drive management

Error No.	Meaning	Reaction	Troubleshooting
160	Timeout communication	adjustable	Remove the timeout of the Proprog communication
161	Timeout BACI	adjustable	Remove the timeout of the BACI communication option module
162	Timeout cyclic communication	adjustable	Remove the timeout of the Cyclic communication:
163	Timeout service data	adjustable	
164	Field bus error	adjustable	Check the field bus communication
165	Controller not synchronous to external signal	adjustable	Set the Sync offset and/or Sync tolerance
166	Error at brake control	IS	Check the wiring and the function of the brake
167	No release of holding brake when starting the drive	IS	Check the holding brake
168	No closing of holding brake at stopping of drive	adjustable	
169	Error holding brake status (cyclic monitoring)	adjustable	
170	Error holding brake lining	adjustable	
171	Error initialize holding brake	IS	Check, if there is a DIO module, if it is in the correct slot and if it is correctly parameterized (also refer to P0883)
172	Error holding brake: holding torque not reached	IS	Ensure that the torque limits are not set too small P1402 < Min (P1036 , P1037 , P1038)
173 to 175	Reserved, not assigned = 0		

P0212 Error data set management

Error No.	Meaning	Reaction	Troubleshooting
176	EEPROM copy error	adjustable	Copy the data set once more
177	Write timeout EEPROM	adjustable	The data in the EEPROM are invalid, please safe all data sets
178	Checksum error EEPROM	IS	EEPROM faulty or described faulty
179	No boot data set	IS	The data in the EEPROM are invalid, please safe all data records
180	Incompatible software	IS	
181	There is no data set	adjustable	
182	Checksum error im PSI module	adjustable	PSI EEPROM faulty or write faulty
183	PSI is reset	adjustable	Please save all data records
184	PSI data invalid	adjustable	The data in the PSI are invalid, please save all data sets
185	Autotuning tables invalid.	adjustable	Restart autotuning
186	A/D correction table invalid	adjustable	Replace the controller cartridge
187	EEPROM is reset	IS	The data in the EEPROM is reset, please safe all data records
188 to 191	Reserved, not assigned = 0		

9.4 Error handling

P0213 Error position controller

Error No.	Meaning	Reaction	Troubleshooting
192	Position deviation dynamic	adjustable	Remove the dynamical position deviation error
193	Position deviation static	adjustable	Remove the statical position deviation error
194	Encoder 1 is used for position control, but is inactive.	IS	Activate encoder 1/2 This error is also shown, if the faulty positioning is in one of the inactive data sets.
195	Encoder 2 is used for position control, but is inactive.	IS	
196	Software limit switch 1 exceeded	adjustable	Check the target position with the travelling range enabled by the limit switches
197	Software limit switch 2 exceeded	adjustable	
198	Hardware limit switch 1 exceeded	adjustable	
199	Hardware limit switch 2 exceeded	adjustable	
200	Homing necessary and not yet executed	adjustable	Start homing
201	Mode set-of-setpoints, set-of-setpoints not in time	adjustable	Assure, that positioning data and handshake are in time (also refer to parameter manual)
202	Target position \geq Modulo position	adjustable	Minimize target position or adjust Modulo position P1239
203	Spindle positioning: Error while initialization of the trigger	adjustable	Used encoder without trigger signal (zero pulse) or incorrect adjustment in P1425 spindle positioning mode
204	Spindle positioning: Timeout at trigger signal	adjustable	Check encoder for zero pulse; check encoder connector; check zero pulse signal by means of the toggle bit (encoder 1/2 status bit 8)
205	Error while executing homing	adjustable	Check the function of the reference switch and the hardware limit switch; adjust the encoder input selection where necessary; select only supported homing methods
206 to 207	Not assigned = 0		

P0214 Error speed controller

Error No.	Meaning	Reaction	Troubleshooting
208	Drive blocked	IS	Remove the blockade of the drive
209	Encoder 1 is parameterized as encoder for the motor control, but the evaluation is not activated. This error is also shown, if the faulty setting is in one of the inactive data records.	IS	You have got to either activate the encoder in the encoder 1 (modeP0150) or you set the encoder 2 as encoder for the position control (parameter P1030)
210	Encoder 2 is parameterized as encoder for the motor control, but the evaluation is not activated. This error is also shown, if the faulty setting is in one of the inactive data records.	IS	You either have got to activate the encoder in the encoder 2 (P0160) or you set the encoder 1 as encoder for the position control (parameter P1030)
211	Overspeed Open loop	IS	Check parameterization and reduce speed
213	Export restriction: Maximum electrical frequency exceeded	IS	Reduce speed
214 to 223	Not assigned = 0		

P0215 Error user programmable

Error No.	Meaning	Reaction	Troubleshooting
224 to 234	Not assigned = 0	adjustable	
235	Torque coupling: General error in the master	adjustable	
236	Torque coupling: Operating mode in the slave is not speed control	IS	
237	Configuration error reaction return motion is invalid	IS	
238	Return motion target position was not reached	adjustable	
239	Application error (enabled by P0302 bit 1)	adjustable	

P0216 Error CANsync

Error No.	Meaning	Reaction	Troubleshooting
240 to 255	Not assigned = 0		

9.4.2.2 Sub-error messages (3rd level)



NOTE!

3rd level errors are only displayed in ProDrive separated by a decimal point from the corresponding 2nd level error (refer to [►Figure 107◄](#) on page 246), exception error power supply monitor P036 (refer to [►Seite 259◄](#)).

e.g.:

Motor error 102: Group error

Find notch position error 102.64: Drive moved more than 4 times delta angle.

(3rd level)

P0233

Error power unit - serial interface

Error power unit 80: Communication error

Error code	Meaning	Troubleshooting
6	Data overflow	Error indicates high EMC problems; please reduce these. Contact Baumüller Nürnberg GmbH
7	Bit frame error	
8	Invalid command state	
9	Parity error	
10	Checksum error	
11	Unknown error code	
12	Data number error	
13	Invalid argument	
14	Data field is write protected	
15	Invalid access code	
16	Data field is not changeable in its size	
17	Word address outside of data field	
18	Data field is nonexistent	
36	Wrong data checksum	
37	No response	
66	Invalid response	

P0234

Error encoder 1 - serial interface

P0235

Error encoder 2 - serial interface

Error encoder 1 112: Communication error encoder 1

Error encoder 2 128: Communication error encoder 2

Error code	Meaning	Troubleshooting
1	Analog signals out of range	Check the encoder cable and the encoder connection
2	Error internal angle offset	
3	Table data field partitioning destroyed	
4	Analog limits not available	
5	Internal I ² C-bus not operative	
6	Internal checksum error	
7	Internal watchdog error - encoder reset	
8	Overflow of the counter	
9	Parity error	
10	Checksum error	
11	Unknown error code	
12	Data number error	
13	Invalid argument	
14	Data field is write protected	
15	Invalid access code	
16	Data field is not changeable in its size	
17	Word address outside of data field	
18	Data field is available	
19 to 27	Reserved	
28	Absolute monitoring of the analog signals	Check the encoder cable and the encoder connection
29	Transmission current critical	
30	Encoder temperature critical	Check motor temperature
31	Speed too high - no position generation possible	Check the encoder cable and the encoder connection
32	Position singleturn unreliable	
33	Multiturn position error	Internal encoder error Contact Baumüller Nürnberg GmbH
34	Multiturn position error	
35	Multiturn position error	
36	Incorrect motor temperature check sum	Check the encoder cable and the encoder connection
37	No response from encoder	
38	Encoder address unknown	
39	Error reading the absolute angle position	
40	Invalid checksum of received data	
41	Unknown encoder type	
42 to 63	Reserved	
64	No response of Hiperface® encoder	Check the encoder cable and the encoder connection
65	No response of Hiperface® encoder	
66	Undefined response to encoder command	
67	Encoder type not accepted	Use another encoder type
68 to 79	Reserved	

9.4 Error handling

Error code	Meaning	Troubleshooting
80	CRC has generated an error	Check the encoder cable and the encoder connection
81	Invalid command	
82	Error in response telegram	
83	Alarm bit is set	Restart b maXX 4000
84	Memory is used	Check the encoder cable and the encoder connection
85	Incorrect data checksum	
86	Motor data length and/or data version of encoder and controller firmware are not identical	
87	No EnDat interface	
88	Exceeding the evaluable transmission format	Use another type of length measurement system
89	Exceeding the evaluable measuring step	
90	Signal period length < measuring step length	
91	EnDat 2.2: Error initializing master module	Exchange module (standard controller) or exchange controller (ES controller)
92	EnDat 2.2: Timeout measuring the signal transfer time	Exchange encoder cable or module (standard controller) or change controller (ES controller)
93	EnDat 2.2: Error - signal transfer compensation is switched-off	Exchange module (standard controller) or exchange controller (ES controller)
94	EnDat 2.2: Encoder type does not support EnDat2.2 (command set, power supply, clock frequency)	Use suitable encoder type
95	EnDat 2.2: RM bit is not set, reference of encoder absolute position is not available	
96	Error lightning	Exchange encoder
97	Error signal amplitude	
98	Error position value	
99	Error overvoltage	Exchange module (standard controller) or exchange controller (ES controller)
100	Error undervoltage	
101	Error overcurrent	
102	Error battery	Exchange encoder
103 -111	Reserved	
112	Position error detected at multiple request	Check encoder cable or installation
113	Error triggered by additional info 1	Refer to encoder-dependent definition of additional information 1
114	Error triggered by additional info 2	Refer to encoder-dependent definition of additional information 2
115	Error triggered by additional info 3	Refer to encoder-dependent definition of additional information 3
116	Error triggered by additional info 4	Refer to encoder-dependent definition of additional information 4
117	Error triggered by additional info 5	Refer to encoder-dependent definition of additional information 5
118	Error triggered by additional info 6	Refer to encoder-dependent definition of additional information 6
119	Error triggered by additional info 7	Refer to encoder-dependent definition of additional information 7

2 encoders can be connected to a **b maXX 4000** at most. Accordingly errors can appear in function module 1 and function module 2. The term „encoder 1“ or „encoder 2“ in the column „device part“ stands for one of the five currently existing encoder module types.

P0236

Error power supply monitor

Exception:

More than one bit can be set. ProDrive shows the single errors with bit No. for identification instead of error codes.

Error code	Bit	Meaning	Reaction	Troubleshooting
1	0	Power supply monitor has detected power failure	adjustable	Correct fault in power supply
2	1	Power supply monitor phase failure	adjustable	
4	2	Power supply monitor has detected undervoltage power supply	adjustable	
8	3	Power supply monitor has detected overvoltage power supply	adjustable	
16	4	Power supply monitor has detected power supply frequency below/equal than lower frequency limit	adjustable	
32	5	Power supply monitor has detected power supply frequency higher/equal than upper frequency limit	adjustable	

P0237 Error at finding notch position

If the function finding notch position is not completed without error, the motor error 102, group error finding notch position is generated.

In this case the following parameter P0237 specifies the error in detail.

Error code	Meaning	Troubleshooting
1	Overcurrent step 1 <ul style="list-style-type: none"> Error occurs at 180 % of maximum current P1241 	Find notch position method 2: <ul style="list-style-type: none"> Either allow higher current, increase peak current P1241, or impress less current, reduce amplitude of voltage P2122 (or P2148).
2	Overcurrent step 2 <ul style="list-style-type: none"> Error occurs at 180 % of maximum current P1241 	Find notch position method 2: <ul style="list-style-type: none"> Either allow higher current, increase peak current P1241, or impress less current, reduce amplitude of voltage P2123 (or P2149).
4	Plausibility step 1 <ul style="list-style-type: none"> Find notch position method 0, 3: Current is too low or shaft is too immovable or the direction of the rotating field P0087 is wrong. Find notch position method 2: Following controller does not converge to a steady rotor position (the following controller should calculate the same value from different start values with unchanged rotor position) 	Find notch position method 0, 3: <ul style="list-style-type: none"> Check amplitude of current, the movability of the shaft and/or the direction of phase rotation P0087. Find notch position method 2: <ul style="list-style-type: none"> Increase gain of the following controller P2124 (preferred) or/and increase amplitude of voltage P2122 (or P2148). If P2122 (or P2148) is at maximum already, then reduce the frequency of the current P2120.
8	Plausibility step 2 <ul style="list-style-type: none"> Find notch position method 2: The measured part of the 2nd harmonic (P2147 from FW 3.10) is less than the minimal level P2125. Find notch position method 3: Drive shaft moves more than 180 ° 	Find notch position method 2: <ul style="list-style-type: none"> Increase amplitude of voltage P2123 (or P2149). If P2123 (or P2149) is at maximum already, then reduce the frequency of the current P2121. If the current is at maximum, then reduce minimum level P2125 (attention: the stability of this method is reduced when setting the minimal level too low. Find notch position method 3: <ul style="list-style-type: none"> Decrease amplitude of current and/or check direction of the rotating field P0087.
32	Timeout	Find notch position method 1: <ul style="list-style-type: none"> Try method 3 Find notch position method 3: <ul style="list-style-type: none"> Increase current rising P3021 and/or decrease waiting time P2127.
64	Drive moved more than 4 times traverse angle	Find notch position method 3: <ul style="list-style-type: none"> Increase the maximum traverse angle P2128 (drives with high friction, cogging torque, initial break away torque) Reduce current increase P3021 and/or speed delta rho P3022 (drives with negligible inertia/friction)
512	Plausibility step 2. test invalid (from FW 03.10) <ul style="list-style-type: none"> The amplitude of the injected signal is too low to detect the 2nd harmonic 	Find notch position method 2: <ul style="list-style-type: none"> Increase amplitude of voltage P2123 (or P2149). If P2123 (or P2149) is at maximum already, then reduce the frequency of the current P2121

P0240 to P0244 Error in function module A to E

Error code	Meaning	Reaction	Troubleshooting
0	Reserved		
1	Module not recognized	no reaction	Check if you have plugged in the right module at the right position
2	Recognized module not permitted at this position	no reaction	
3	Digital output short-circuited or 24 V supply not connected at DIO module	no reaction	Check the cabling of the digital outputs
4	Invalid target parameter value by digital input	no reaction	Check the parameterization of the input channel
5	Direct PLC I/O access for this module not permitted.	no reaction	Don't select the module
6	Required module is missing, only for BM4100 active mains rectifier unit	IS	Connect the required module for active mains rectifier unit operation - refer to Operation Manual b maXX BM4100 Active Mains Rectifier Unit
7	Module must not be used for actual active mains rectifier unit mode or controller mode	no reaction	
8	Reserved	no reaction	
9	Too many analog I/O modules plugged	no reaction	More than 2 analog IO modules are not allowed
10	AIO-04: current < 4 mA	no reaction	Current supply not connected, cable break or short circuit
11	AIO-04: current > 20 mA	no reaction	Current supply supplies a current too high

P0245 to P0250 Error in option module G to M

Error code	Meaning	Reaction	Troubleshooting
4096	Wrong parameter No. at set value parameter 1	adjustable	Check the corresponding set value parameter
4097	Wrong parameter No. at set value parameter 2	adjustable	
4098	Wrong parameter No. at set value parameter 3	adjustable	
4099	Wrong parameter No. at set value parameter 4	adjustable	
4100	Wrong parameter No. at set value parameter 5	adjustable	
4101	Wrong parameter No. at set value parameter 6	adjustable	
4102	Wrong parameter No. at set value parameter 7	adjustable	
4103	Wrong parameter No. at set value parameter 8	adjustable	
4104	Wrong parameter No. at set value parameter 9	adjustable	
4105	Wrong parameter No. at set value parameter 10	adjustable	
4106	Wrong parameter No. at set value parameter 11	adjustable	
4107	Wrong parameter No. at set value parameter 12	adjustable	
4108	Wrong parameter No. at set value parameter 13	adjustable	
4109	Wrong parameter No. at set value parameter 14	adjustable	
4110	Wrong parameter No. at set value parameter 15	adjustable	
4111	Wrong parameter No. at set value parameter 16	adjustable	
4112	Wrong parameter No. at actual value parameter 1	adjustable	
4113	Wrong parameter No. at actual value parameter 2	adjustable	
4114	Wrong parameter No. at actual value parameter 3	adjustable	
4115	Wrong parameter No. at actual value parameter 4	adjustable	
4116	Wrong parameter No. at actual value parameter 5	adjustable	
4117	Wrong parameter No. at actual value parameter 6	adjustable	
4118	Wrong parameter No. at actual value parameter 7	adjustable	
4119	Wrong parameter No. at actual value parameter 8	adjustable	
4120	Wrong parameter No. at actual value parameter 9	adjustable	
4121	Wrong parameter No. at actual value parameter 10	adjustable	
4122	Wrong parameter No. at actual value parameter 11	adjustable	
4123	Wrong parameter No. at actual value parameter 12	adjustable	
4124	Wrong parameter No. at actual value parameter 13	adjustable	
4125	Wrong parameter No. at actual value parameter 14	adjustable	
4126	Wrong parameter No. at actual value parameter 15	adjustable	
4127	Wrong parameter No. at actual value parameter 16	adjustable	
4128	Invalid value at set value parameter No. 1	adjustable	Check the set values in relation to the permitted value range
4129	Invalid value at set value parameter No. 2	adjustable	
4130	Invalid value at set value parameter No. 3	adjustable	
4131	Invalid value at set value parameter No. 4	adjustable	
4132	Invalid value at set value parameter No. 5	adjustable	
4133	Invalid value at set value parameter No. 6	adjustable	
4134	Invalid value at set value parameter No. 7	adjustable	
4135	Invalid value at set value parameter No. 8	adjustable	
4136	Invalid value at set value parameter No. 9	adjustable	
4137	Invalid value at set value parameter No. 10	adjustable	
4138	Invalid value at set value parameter No. 11	adjustable	
4139	Invalid value at set value parameter No. 12	adjustable	

Error code	Meaning	Reaction	Troubleshooting
4140	Invalid value at set value parameter No. 13	adjustable	Check the set values in relation to the permitted value range
4141	Invalid value at set value parameter No. 14	adjustable	
4142	Invalid value at set value parameter No. 15	adjustable	
4143	Invalid value at set value parameter No. 16	adjustable	
4144	Invalid value for set value period	adjustable	
4145	Invalid value for actual value period	adjustable	
4146	Incorrect value for cycle offset set values	adjustable	
4147	Incorrect value for cycle offset actual values	adjustable	
4148	BACI timeout at cyclic data	adjustable	Check communication rate and set timeout P0839
4149	BACI timeout at service data	adjustable	
4150	Check results in faulty checksum	IS	Restart by switching off and on
4151	Ramp-up timeout when waiting for the slave type or when waiting for the resetting of config pending flag	adjustable	
4152	Invalid data transfer structure type	adjustable	Contact Baumüller Nürnberg GmbH
4153	Internal error: Incorrect BACI status	adjustable	
4154	Access conflicts with slave at cyclic communication	adjustable	
4155	Error cyclic communication: Parameter value wrong	adjustable	Check the value of the transmitted parameter
4156	Error cyclic communication: Alive counter conflict	adjustable	Check if option module and controller are synchronous
4157	Cmd interface: Channel number wrong (0 or > 6)	adjustable	Contact Baumüller Nürnberg GmbH
4158	Cmd interface: Selected channel not available	adjustable	
4159	Cmd interface: Internal error - wrong pointer	adjustable	
4160	Cmd interface: Internal error - wrong state	adjustable	
4161	Cmd interface: Wrong package No.	adjustable	
4162	Cmd interface: Wrong command No.	adjustable	
4163	Cmd interface: Wrong state at package handling	adjustable	
4164	Cmd interface: Timeout at command processing	adjustable	
4165	Cmd interface: Wrong package length	adjustable	
4166	Cmd interface: Descriptor not available	adjustable	
4167	Cmd interface: Wrong package type	adjustable	
4168	Cmd interface: Checksum error	adjustable	
4169	Module identification: PCI error at reading	adjustable	Check option module for correct operation
4170	Module identification: PCI error at writing	adjustable	
4171	Module identification: General error at reading	adjustable	
4172	Module identification: General error at writing	adjustable	
4173	Internal error	adjustable	Contact Baumüller Nürnberg GmbH
4174	Configuration cyclic services: Parameters are not cyclic writable	adjustable	Select another parameter
4175	Configuration cyclic services: Invalid parameter No.	adjustable	
4176	Wrong option module error code	adjustable	Contact Baumüller Nürnberg GmbH
4177 to 8192	Reserved		

9.4 Error handling

9.4.3 Warnings

P0261 Warning power supply

Warning No.	Meaning	Troubleshooting
0	Not assigned = 0	
1	Undervoltage 24 V	Assure the compliance with the specifications
2	Undervoltage power supply	Assure the compliance with the specifications (refer to ►Requirements to the energy supply / supply system◄ from page 54)
3	Overvoltage power supply	
4	Power failure	Power supply troubleshooting
5	Phase failure	Check if all phases are correctly connected and voltage-carrying
6 to 15	Not assigned = 0	

P0262 Warnings power unit

Warning No.	Meaning	Troubleshooting
16	Internal temperature of device	Establish the specified environmental conditions, assure correct ventilation conditions
17	Heat sink temperature	Reduce the power output, check the fans of the device
18	Timeout charge process DC link	Check the correct order of mains phases (clockwise rotating field!) and avoid that the DC link supplies energy while charging
19	Not assigned = 0	
20	Safety relay not enabled	Check cabling of safety relay
21 to 22	Reserved warning	
23	Voltage difference power supply - DC link > 40 V	Check power terminals
24	Power unit overload	Reduce the power output
25 to 31	Not assigned = 0	

P0263 Warnings motor

Warning No.	Meaning	Troubleshooting
32	Temperature threshold 1 exceeded	Reduce the power output of the motor
33	Temperature threshold 2 exceeded	
34	I ² t threshold exceeded	
35 to 47	Not assigned = 0	

P0264 Global drive warnings

Warning No.	Meaning	Troubleshooting
48	Drive not synchronous	
49 to 51	Reserved	
52	Warning encoder 1	Exchange of the encoder recommended
53	Warning encoder 2	Exchange of the encoder recommended
54 to 63	Not assigned = 0	

P0265 Warning Power supply monitor

Warning No.	Meaning	Troubleshooting
64	Power supply monitor has detected warning power failure	
65	Power supply monitor has detected warning phase failure	
66	Power supply monitor has detected a lower voltage than warning threshold undervoltage power supply P2058	
67	Power supply monitor has detected a higher voltage than warning threshold overvoltage power supply P2059	
68	Power supply monitor has detected power supply frequency below/equal than warning lower frequency limit P2060	
69	Power supply monitor has detected power supply frequency higher than warning upper frequency limit P2061	

MAINTENANCE

10.1 Safety notes

Basic information



DANGER!

Risk of fatal injury from electrical current!

Inevitably, when operating this electrical device, certain parts of it are energized with hazardous voltage.

Therefore:

- Pay heed to areas on the device that could be dangerous during the electrical installation.
- Pay heed to areas on the device that could still be electrically energized after operation.

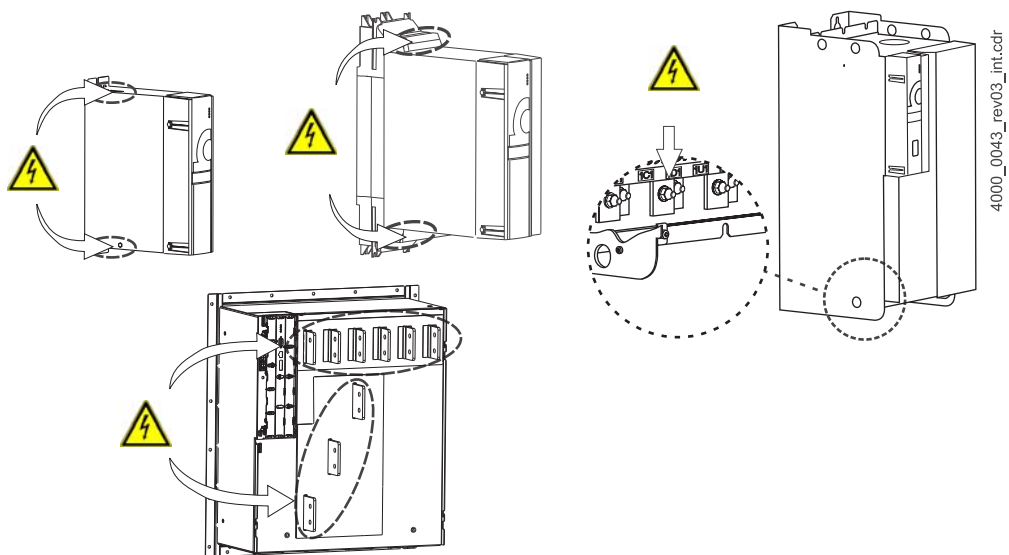

Figure 108: Hazard areas during electrical installation



WARNING!

Risk of injury due to improperly performed maintenance work!

Improper maintenance can lead to severe personal injury and material damage.

Therefore:

- Before beginning work, make sure that there is enough space for mounting.
- Make sure that the mounting area is kept clean and orderly. Parts and tools that are loosely stacked or lying around are a potential accident source.

10.2 Environmental condition

If the prescribed environmental conditions are adhered to, then the device is maintenance-free. For the prescribed environmental conditions refer to [►Required environmental conditions](#) on page 57.

10.3 Inspection intervals - maintenance notes

Preventive maintenance is prescribed to keep the device in an optimum operating condition and ensure a long service life. It is recommended to have inspections performed regularly by qualified personnel.

Daily inspection:

Basic check points as to whether discrepancies have occurred during operation:

- Does the motor work as desired?
- Is the operating environment normal?
- Is the cooling system working normally?
- If an unusual vibration or noise is noticed during operation.
- Does the motor overheat during operation?

Regularly scheduled inspection:

Before checking, switch off the input voltage and wait until the device's capacitors have discharged.

**DANGER!****Risk of fatal injury from electrical current!**

Therefore:

- Switch off voltage before performing work!
- Only qualified personnel may mount, install and maintain the devices.
- Please remove all metallic objects worn, such as watches or rings, for example, before beginning to work on the device.
- Only insulated tools are permitted.

**DANGER!****Risk of fatal injury from electrical current!**

Stored electric charge.

Discharge time of the system = discharge time of the device with the longest DC link discharge time in the DC link connection.

Refer to [►Electrical data basic units◄](#) from page 65.

Therefore:

- Do not touch before taking into account the discharge time of the capacitors and electrically live parts.
- Heed corresponding notes on the equipment.
- If additional capacitors are connected to the DC link, the DC link discharge can take a much longer time. In this case, the necessary waiting period must be determined or a measurement made as to whether the equipment is de-energized. This discharge time must be posted, together with an IEC 60417-5036 (2002-10) warning symbol, on a clearly visible location of the control cabinet.

10.3 Inspection intervals - maintenance notes

10.3.1 Periodic maintenance

- Environmental condition

Check points	Methods and criteria	Inspection intervals		
		Daily	Semi-annually	Annually
Check environmental temperature, humidity and vibrations. Check whether dust, oil or drops of water appear.	Visual inspection and measurement of the environmental conditions, comparison with standard values.	○		
Check whether there are hazardous objects in the vicinity.	Visual inspection	○		

- Voltage

Check points	Methods and criteria	Inspection intervals		
		Daily	Semi-annually	Annually
Check the voltage of the power supply system and the control circuits	Measurement and comparison with standard values.	○		

- Mechanical parts

Check points	Methods and criteria	Inspection intervals		
		Daily	Semi-annually	Annually
Are there any abnormal noises or vibrations?	Visual and audio check		○	
Are there any loose screws?	Tighten the screws.		○	
Are there any bent or damaged parts?	Visual inspection		○	
Have there been any color changes due to overheating?	Visual inspection		○	
Are there any dust or dirt deposits?	Visual inspection		○	

- Power supply

Check points	Methods and criteria	Inspection intervals		
		Daily	Semi-annually	Annually
Are there any missing or loose screws?	Replace the screws or, respectively, tighten them.		○	
Is there any deformation, cracking, damage or color change on the device as a result of overheating or aging?	Visual inspection		○	
Are there any dust or dirt deposits?	Visual inspection		○	

- Connections and circuitry of the mains power supply

Check points	Methods and criteria	Inspection intervals		
		Daily	Semi-annually	Annually
Does the wiring indicate any color or shape changes due to overheating?	Visual inspection		○	
Is the wiring insulation damaged or is it discolored?	Visual inspection		○	
Is there any damage?	Visual inspection		○	

- Transformer and chokes in the main circuit

Check points	Methods and criteria	Inspection intervals		
		Daily	Semi-annually	Annually
Are there any abnormal vibrations or noticeable odors?	Visual inspection, audio check and odor check		○	

- Solenoid switch and relay in the power supply circuit

Check points	Methods and criteria	Inspection intervals		
		Daily	Semi-annually	Annually
Are there any loose screws?	Visual and audio check Tighten screws, if necessary.	○		
Do the switches function correctly?	Visual inspection	○		

- Plug connectors in the power supply circuit

Check points	Methods and criteria	Inspection intervals		
		Daily	Semi-annually	Annually
Are there any loose screws or connectors?	Tighten screws and firmly stick in plug connector.		○	
Are there any noticeable odors or color changes?	Visual inspection and odor check		○	
Is there any cracking, damage, deformation or corrosion?	Visual inspection		○	
Is there any leaking fluid or deformation of the capacitors?	Visual inspection		○	

10.4 Repairs

- Cooling system fans

Check points	Methods and criteria	Inspection intervals		
		Daily	Semi-annually	Annually
Are there any abnormal noises or vibrations?	Visual and audio check			○
Are there any loose screws?	Tighten the screws.			○

- Cooling system ventilation duct

Check points	Methods and criteria	Inspection intervals		
		Daily	Semi-annually	Annually
Are there any obstructions in the heat sink, air supply or air outlet?	Visual inspection	○		

10.4 Repairs

In case of device damage, please inform your sales office or:

Baumüller Nürnberg GmbH

Ostendstr. 80 - 90
90482 Nuremberg
Germany

Tel. +49 9 11 54 32 - 0
Fax: +49 9 11 54 32 - 1 30

Mail: mail@baumueller.com
Internet: www.baumueller.com

11

ACCESSORIES AND SPARE PARTS

Accessories/spare parts for devices of the **b maXX** series are listed in this appendix. Product management is happy to handle any queries and suggestions on accessory parts.

11.1 Cabling

11.1.1 Cables power supply - device

Device	Number of wires x cross section ¹⁾	Connection to device ³⁾	Maximum length ²⁾
BM441X	4 x 0.5 to 2.5 mm ² (AWG 16 - 12)	Flexible cable with/without wire end ferrule (plug-in terminal)	Power supply to mains filter: user-defined mains filter to power choke/ device: max. 30 cm
BM442X	4 x 0.5 to 4 mm ² (AWG 24 - 10)	Flexible cable with wire end ferrule (screw terminal)	
BM4432 BM4433 BM4434	4 x 0.5 to 10 mm ² (AWG 20 - 6)	Flexible cable with wire end ferrule (screw terminal)	
BM4435 ⁴⁾	4 x 16 mm ² 63 A-fuses must be provided for the cable protection and a cable with 16 mm ² cross section must be used.	Pin-cable-lugs according to DIN 46230 The terminals at the BM4435 are provided for cross sections up to 10 mm ² , therefore at the BM4435 pin-cable-lugs according to DIN 46230 must be used.	
BM4632	4 x 25 mm ² 63 A-fuses must be provided for the cable protection and a cable with 25 mm ² cross section must be used.	Flexible cable with wire end ferrule (screw terminal)	
BM444X BM464X	4 x 16 to 50 mm ² (AWG 6 - 0)	Flexible cable with wire end ferrule (screw terminal)	
BM445X BM465X BM475X	4 x 25 to ca. 185 mm ²	Cable lug max. width: 25 mm (current bar) ⁵⁾	
BM446X BM466X BM476X		Cable lug max. width: 35 mm (current bar) ⁶⁾	
BM447X BM477X	Max. 4 cables with (4 x 95 mm ²) Max. 2 cables with (4 x 185 mm ²)	Cable lug max. width: 25 mm or 35 mm (current bar) ⁷⁾	

¹⁾ Possible cross section

For UL conform machines/installations you must use UL certified circuit cables.

²⁾ The length of the cable between mains filter and power supply is not of importance for the compliance to the EMC regulation.

³⁾ The installing of the cables is user-defined.

⁴⁾ NOTE BM4435, BM4635

The BM4435 has an input current of 53 A, the appropriate mains filter (BFN3-1-56-001) has a rated current of 53 A, too.

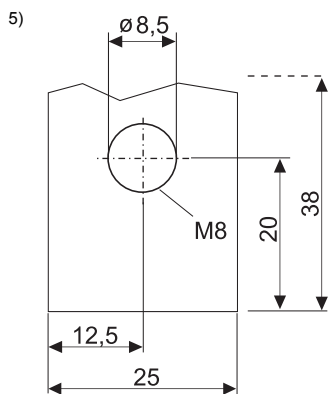

4000_0028_rev01_int.cdr

Connection lugs ((current bars). Position refer to [►Figure 91◄](#) on page 193
Screw maximum two cable lugs to the current bar - one on the front side, one on the reverse side of the bar.

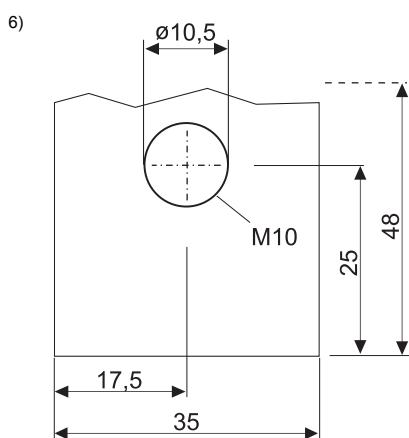

4000_0029_rev01_int.cdr

Connection lugs (current bars). Position refer to [►Figure 91◄](#) on page 193
Screw maximum two cable lugs to the current bar - one on the front side, one on the reverse side of the bar.

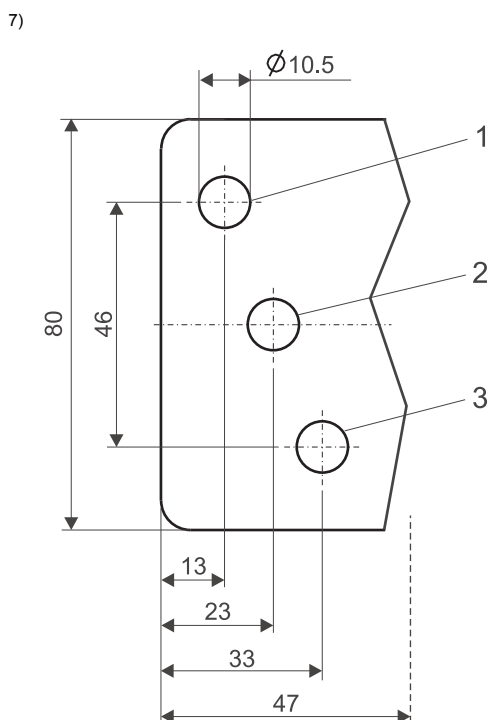

4000_0677_rev01_int.cdr

Connection lugs (current bars). Position refer to [►Figure 94◄](#) on page 196

At connection cross-section 95 mm², Cable lug width max. 25 mm:
Screw maximum two cable lugs to the current bar - one on the front side, one on the reverse side of the bar.

At connection cross-section 185 mm², Cable lug width max. 35 mm:
Screw two cable lugs to the current bar at maximum- one on the front side, one on the reverse side of the bar.

11.1.2 Cables device - motor

Device	Number of wires x cross section ¹⁾	Maximum length ²⁾³⁾	Connection to device
BM441X	4 x (1 to 2.5 mm ²) (AWG 16 - 12)	100 m	Flexible cable with/without wire end ferrule (plug-in terminal)
BM442X	4 x (2 to 4 mm ²) (AWG 24 - 10)	1.5 to 2,5 mm ² : 100 m from 4 mm ² : 60 m	Flexible cable with wire end ferrule (screw terminal)
BM443X BM4632	4 x (4 to 16 mm ²) (AWG 20 - 4)	60 m	
BM4443 BM4444 BM4641 BM4642	4 x (16 to 50 mm ²) (AWG 6 - 0)	Up to 25 mm ² : 60 m From 35 mm ² : 50 m	
BM4445 BM4446	4 x (16 to 50 mm ²) (AWG 6 - 0) 4 x 16 to 95 mm ² ⁴⁾		
BM445X BM465X BM475X	4 x (20 to ca. 185 mm ²)	Up to 50 mm ² : 50 m > 50 mm ² : 15 m	Cable lug max. width: 25 mm (current bar) ⁵⁾
BM446X BM466X BM476X			Cable lug max. width: 35 mm (current bar) ⁶⁾
BM447X BM477X	Max. 4 cables each with (4 x 95 mm ²) Max. 4 cables each with (2 x 185 mm ²)	At 95 mm ² : 15 m At 185 mm ² : 30 m	Cable lug max. width: 25 mm or 35 mm (current bar) ⁷⁾

¹⁾ Possible cross section

Use a screened circuit Baumüller-line, optical shield coverage > 85%. Do not use single conductors.
For UL conform machines/installations you must use UL certified circuit cables.

²⁾ Only for Baumüller cables with this maximum length and by usage of a Baumüller mains filter you can assume, that the limit values of the EMC product standard EN 61800-3 are complied with.

Available Baumüller cables see Baumüller motor documentation.

³⁾ In case you use n parallel-installed motor cables, the maximum length is to be reduced by the factor 1/n.

⁴⁾ After January 2018 delivery date: The devices provide connection terminals for larger cable cross-section.

5)

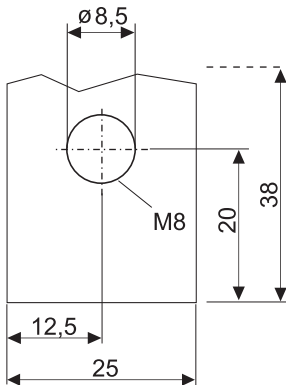

4000_0028_rev01_int.cdr

Connection lugs (current bars). Position refer to [►Figure 91◀](#) on page 193
Screw maximum two cable lugs to the current bar - one on the front side, one on the reverse side of the bar.

6)

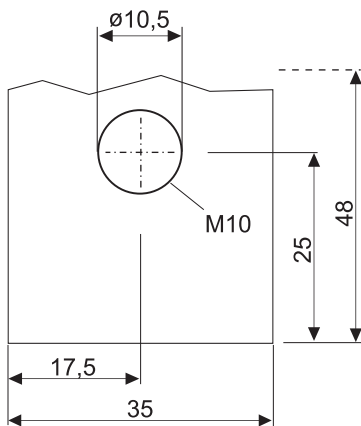

4000_0029_rev01_int.cdr

Connection lugs (current bars). Position refer to [►Figure 91◀](#) on page 193
Screw maximum two cable lugs to the current bar - one on the front side, one on the reverse side of the bar.

7)

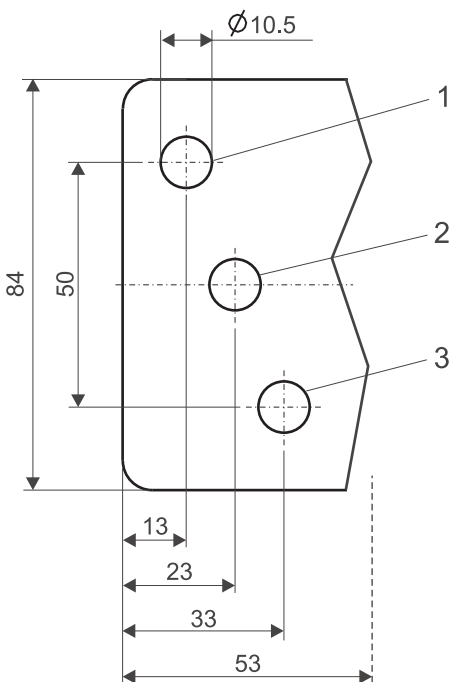

4000_0569_rev01_int.cdr

Connection lugs (current bars). Position refer to [►Figure 94◀](#) on page 196

At a connection cross-section of 95 mm², cable lug width max. 25 mm:
Screw maximum two cable lugs to the current bar - one on the front side, one on the reverse side of the bar.

At a connection cross-section of 185 mm², cable lug width max. 35 mm:
Screw two cable lugs to the current bar at maximum- one on the front side, one on the reverse side of the bar.

11.1.3 Cable control voltage supply/signals

Cross section ¹⁾	≤ 1.5 mm ²
Maximum length ²⁾	User-defined
Connection to device	With /without wire end ferrules (plug-in terminal)

¹⁾ The installing of the cables is user-defined.

²⁾ The length of the cable has no influence on the compliance to the EMC regulation.

11.1.4 Interface cable RS232

A pre-assembled cable is available as a spare part, refer to [►Cable RS232◄](#) on page 310.

1 Use the following materials:

- Cable: LIYCY 6x2x0.14 mm²
- D-sub connectors, 9-pin, female, cabinet plastics metalized
- D-sub connector, 9-pin, male, cabinet plastics metalized

2 Connect the cable shield with the cabinet and with the shield of the D-sub connector

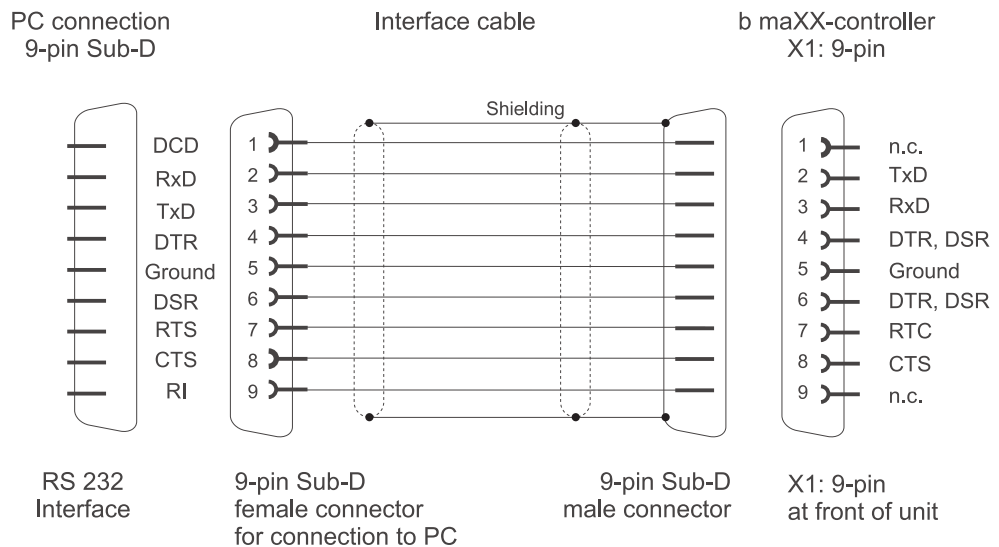

4000_0564_rev01.cdr

Figure 109: Interface cable RS 232

11.2 Fuses

**NOTE!**

The fuse specification are valid for basic units, only.

A distinction is made between protecting the power supply cables and protecting the device. To fulfill CE specifications – here in particular EN 60204-1 – fuse the power supply cables.

**NOTE!**

Approved, UL-listed safety fuses and/or circuit breakers must be used in UL-authorized systems.

Cable protection

Use safety fuses of the operating class gL DIN VDE 0636-201 / IEC 60269-2-1 / HD 630.2.1 54 or circuit breaker triggering characteristic K, in accordance with DIN VDE 0636-201 / IEC 60269-2-1 / HD 630.2.1 54, to protect the cable. These fuses protect against overloads and consequential damage from defects, for example as a result of fire. However, they cannot prevent a device from being extensively destroyed in case of a short circuit or ground fault in the DC link.

Carry out the fusing in accordance with EN 60204-1 („Electrical Equipment of Machines“). Dimension the cable fuse based on the cross-section of the power supply cable used, and in accordance with the respective applicable national standards and local regulations.

The current-carrying capacity of the cables is specified in Table 5 of EN 60204-1. For your application, the corresponding value must still be determined based on the standard itself, i.e. taking into account the cable routing.

**NOTE!**

Use suitable fuses with the tripping characteristic gL or gR.

Device protection Use semiconductor fuses with the tripping characteristic aR (DIN VDE 0636-201 / IEC 60269-2-1 / HD 630.2.1 54). Connect these in series with the cable protection fuses. In the event of a short circuit, these protect the line-side rectifier unit circuit on the input side against complete destruction, in order that it is possible to repair the device.

Dimension suitable device protection fuses depending on peak current and the maximum load integral i^2t_{off} .

Device	Maximum load integral ¹⁾
BM4412	$\leq 310 \text{ A}^2\text{s}$
BM4413	$\leq 310 \text{ A}^2\text{s}$
BM4414	$\leq 325 \text{ A}^2\text{s}$
BM4422	$\leq 400 \text{ A}^2\text{s}$
BM4423	$\leq 450 \text{ A}^2\text{s}$
BM4424	$\leq 800 \text{ A}^2\text{s}$
BM4425	$\leq 800 \text{ A}^2\text{s}$
BM4426	$\leq 800 \text{ A}^2\text{s}$
BM443X (generation 1)	$\leq 1.500 \text{ A}^2\text{s}$
BM443X (generation 2, refer to ►Explanation version code◄ on page 134) BM463X	$\leq 9.500 \text{ A}^2\text{s}$
BM444X BM464X	$\leq 16\,200 \text{ A}^2\text{s}$
BM445X BM465X BM475X	$\leq 97\,000 \text{ A}^2\text{s}$
BM446X BM466X BM476X	$\leq 245\,000 \text{ A}^2\text{s}$
BM447X BM477X	$\leq 1\,051\,000 \text{ A}^2\text{s}$

¹⁾ Use fuses that fall below the specified cutoff integral (i^2t_{aus}) in the operating point.

- Cable protection + device protection** There are two alternatives for protecting cable and devices:
- Connecting cable protection fuses and semiconductor fuses in series
 - Using full-range fuses with the tripping characteristic gR and gS (DIN VDE 0636-201 / IEC 60269-2-1 / HD 630.2.1 54).

Dimension the suitable cable and devices protection fuses based on the cross-section of the power supply cable used, the peak current and the maximum load integral i^2t_{off} .







In contrast to safety fuses, the device and cables may also be fused with the listed circuit breakers according to UL (DIVQ).

Only circuit breakers without trip delay are approved. Circuit breakers with only a thermal tripping characteristic are not tested and thus not approved. A particular point to consider is that, in case of an error, the device is not protected against destruction; instead, only the system is protected against the risk of fire.

The suitability of circuit breakers depends on the cross-section of the power supply cable used and the dimensioning of the rated and peak current of the devices.

11.2.1 Fuses BM441X

- Full-range fuses gR and gS
BM4412, BM4413, design type NH

Bussmann	000	16A/690V: 170M1559 	20A/690V: 170M1560 
		25A/690V: 170M1561 	
SIBA	000	16A/690V: 2047734/16A c  US	
	00	20A/690V: 2047720/20A	25A/690V: 2047720/25A
	0	16A/1000V: 2038404/16A	20A/1000V: 2038404/20A
		25A/1000V: 2038404/25A	32A/1000V: 2038404/32A
Siemens	000	16A/690V: 3NE1 813-0 c  US	
	00	25A/690V: 3NE8 015-1 c  US	20A/690V: 3NE8 714-1
		25A/690V: 3NE8 715-1	
	0	32A/1000V: 3NE4 101	

Size 







11.2 Fuses

- Semiconductor fuses aR (device)
BM4412, BM4413, design type NH

Bussmann	00	20A/1000V: 170M2673	25A/1000V: 170M2674
	1	40A/690V: 170M3808	
Ferraz Shawmut	000	16A/690V: 6,9 URD 000 PV 016	20A/690V: 6,9 URD 000 PV 020
		25A/690V: 6,9 URD 000 PV 025	
	00	20A/690V: 6,9 URD 00 PV 020	25A/690V: 6,9 URD 00 PV 025
		32A/690V: 6,9 URD 00 PV 032	
	0	32A/690V: 6,9 URD 0 PV 032	40A/690V: 6,9 URD 0 PV 040

Size \longrightarrow \uparrow

- Full-range fuses gR and gS
BM4414, design type NH

Bussmann	000	25A/690V: 170M1561	32A/690V: 170M1562
Ferraz Shawmut	000	16A/690V: 6,9 GGR 000 PV 016	20A/690V: 6,9 GGR 000 PV 020
	00	16A/690V: 6,9 GGR 00 PV 016	
SIBA	000	16A/690V: 2047734/16A	20A/690V: 2047734/20A
	00	35A/690V: 2047720/35A	
	0	16A/1000V: 2038404/16A	25A/1000V: 2038404/25A
		32A/1000V: 2038404/32A	40A/1000V: 2038404/40A
Siemens	000	16A/690V: 3NE1 813-0 c 	20A/690V: 3NE1 814-0 c 
	00	25A/690V: 3NE8 015-1 c 	35A/690V: 3NE8 003-1 c 
		25A/690V: 3NE8 715-1 c 	32A/690V: 3NE8 701-1 c 
	0	32A/1000V: 4NE4 101	40A/1000V: 4NE4 102

Size \longrightarrow \uparrow







- Semiconductor fuses aR (device)
BM4414, design type NH

Bussmann	00	20A/1000V: 170M2673	25A/1000V: 170M2674
		32A/1000V: 170M2675	35A/1000V: 170M2676
	1	40A/690V: 170M3808	
Ferraz Shawmut	000	20A/690V: 6,9 URD 000 PV 020	25A/690V: 6,9 URD 000 PV 025
		32A/690V: 6,9 URD 000 PV 032	40A/690V: 6,9 URD 000 PV 040
	00	25A/690V: 6,9 URD 00 PV 025	32A/690V: 6,9 URD 00 PV 032
		40A/690V: 6,9 URD 00 PV 040	
	0	32A/690V: 6,9 URD 0 PV 032	40A/690V: 6,9 URD 0 PV 040

Size ↑

11.2.2 Fuses BM442X

- Full-range fuses gR and gS
BM4422, design type NH

Bussmann	000	16A/660V: 170M1559 	20A/660V: 170M1560 
		25A/660V: 170M1561 	32A/660V: 170M1562 
	00	16A/690V: 170M2692	20A/690V: 170M2693
		25A/690V: 170M2694	32A/690V: 170M2695
SIBA	000	16A/690V: 2047734/16A  <small>us</small>	
	00	20A/690V: 2047720/20A	25A/690V: 2047720/25A
Siemens	00	16A/690V: 3NE1 813-0  <small>us</small>	20A/660V: 3NE8 714
		25A/660V: 3NE8 715	25A/660V: 3NE8 015
		32A/660V: 3NE8 701	
	0	32A/1000V: 3NE4 101  <small>us</small>	

Size ↑

11.2 Fuses

- Semiconductor fuses aR (device)
BM4422, design type NH

Bussmann	00	20A/1000V: 170M2673	25A/1000V: 170M2674
		32A/1000V: 170M2675	
	1	40A/660V: 170M3808	
Ferraz Shawmut	000	16A/690V: 6,9 URD 000 PV 016	20A/690V: 6,9 URD 000 PV 020
		25A/690V: 6,9 URD 000 PV 025	32A/690V: 6,9 URD 000 PV 032

Size \longrightarrow \uparrow

- Full-range fuses gR and gS
BM4423, design type NH

Bussmann	000	20A/660V: 170M1560 	25A/660V: 170M1561 
		32A/660V: 170M1562 	
	00	20A/690V: 170M2693	25A/690V: 170M2694
		32A/690V: 170M2695	
Ferraz Shawmut	000	20A/690V: 6,9 GGR 000 PV 020	
	00	20A/690V: 6,9 GGR 00 PV 020	
SIBA	000	20A/690V: 2047734/20A c  US	
	00	20A/690V: 2047720/20A	25A/690V: 2047720/25A
Siemens	00	20A/660V: 3NE8 714	20A/690V: 3NE1 814-0 c  US
		25A/660V: 3NE8 715	25A/660V: 3NE8 015
		32A/660V: 3NE8 701	
	0	32A/1000V: 3NE4 101 c  US	





Size \longrightarrow \uparrow

- Semiconductor fuses aR (device) BM4423, design type NH

Bussmann	00	20A/1000V: 170M2673	25A/1000V: 170M2674
		32A/1000V: 170M2675	
	1	40A/660V: 170M3808	
Ferraz Shawmut	000	20A/690V: 6,9 URD 000 PV 020	25A/690V: 6,9 URD 000 PV 025
		32A/690V: 6,9 URD 000 PV 032	40A/690V: 6,9 URD 000 PV 040

Size \longrightarrow \uparrow

- Full-range fuses gR and gS
BM4424, BM4425 and BM4426, design type NH

Bussmann	000	25A/660V: 170M1561 	32A/660V: 170M1562 
	00	25A/690V: 170M2694	32A/690V: 170M2695
Ferraz Shawmut	000	25A/690V: 6,9 GGR 000 PV 025	
	00	25A/690V: 6,9 GGR 00 PV 025	
SIBA	000	25A/690V: 2047734/25A c  US	
	00	25A/690V: 2047720/25A	
Siemens	00	25A/660V: 3NE8 715	25A/660V: 3NE8 015
		25A/690V: 3NE1 815-0 c  US	32A/660V: 3NE8 701
	0	32A/1000V: 3NE4 101 c  US	

Size ↑

- Semiconductor fuses aR (device)
BM4424, BM4425 and BM4426, design type NH

Bussmann	00	25A/1000V: 170M2674	32A/1000V: 170M2675
		40A/1000V: 170M2676	
	1	40A/660V: 170M3808	50A/660V: 170M3809
		63A/660V: 170M3810	
Ferraz Shawmut	000	25A/690V: 6,9 URD 000 PV 025	32A/690V: 6,9 URD 000 PV 032
		40A/690V: 6,9 URD 000 PV 040	50A/690V: 6,9 URD 000 PV 050
Siemens	00	40A/660V: 3NE8 702	

Size ↑

11.2.3 Fuses BM4X3X



NOTE!

Please note, that the fuses must be adapted, if a BM443X generation 1 is replaced by a BM443X generation 2 ([►Explanation version code◄](#) on page 134).

Operation of BM443X generation 1 and generation 2 in combination refer to [►Mix mode BM443X generation 1 and 2◄](#) on page 128.

[Semiconductor fuses aR \(device\) BM443X generation 2](#) refer to next page.

- Full-range fuses gR and gS
BM443X generation 1, design type NH

Bussmann	000	50A/660V: 170M1564	63A/660V: 170M1565
	00	50A/690V: 170M2697	63A/690V: 170M2698
	1	50A/690V: 170M4176	63A/690V: 170M4177
SIBA	00	63A/690V: 2047720/63A	
	1	63A/690V: 2021120/63A	
Siemens	00	63A/660V: 3NE8 018-1	
	0	50A/1000V: 3NE4 117	



Size _____ ↑

- Semiconductor fuses aR
(device) BM443X generation 1, design type NH

Bussmann	00	50A/1000V: 170M2678	63A/1000V: 170M2679
	1	63A/690V: 170M3810	80A/690V: 170M3811
SIBA	0	63A/1000V: 2038404/63A	80A/1000V: 2038404/80A
Siemens	00	50A/660V: 3NE8 717	63A/660V: 3NE8 718
	0	63A/1000V: 3NE4 118	





Size _____ ↑

- Full-range fuses gR and gS
BM443X generation 2 and BM4632, design type NH

SIBA	1	80A/690V: 2021134.80 
Siemens	000	80A/690V: 3NE1820-0 
	00	100A/690V: 3NE1021-2 

Size 

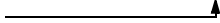

- Semiconductor fuses aR (device) BM443X generation 2 and BM4632, design type NH

Bussmann	000	125A/690V: 170M1568D 	
SIBA	000/80	125A/690V: 2028220.125 	
Siemens	0	100A/1000V: 3NE4 121 	
	00	100A/690V: 3NE8021-1 	125A/690V: 3NE8022-1 
	000/80	125A/690V: 3NE8 722-1 	
	1/110	125A/1000V: 3NE3 222 	

Size 

11.2.4 Fuses BM4X4X

- Full-range fuses gR, gRL, gR/gS, gGR
BM444X, design type NH

Bussmann	00	80A/690V: 170M2699	100A/690V: 170M2700
		125A/690V: 170M2701 ¹⁾	
	1	80A/690V: 170M4178	100A/690V: 170M4179
		125A/690V: 170M4180	160A/690V: 170M4181
Ferraz Shawmut	000	80A/690V: 6,9 GGR 000 PV 080/6,9 GGR 000 D08L 080	
	00	80A/690V: 6,9 GGR 00 PV 080/6,9 GGR 00 D08L 080	
SIBA	1	80A/690V: 2021120-80A	100A/690V: 2021120-100A
		80A/690V: 2021134-80A 	100A/690V: 2021134-100A  ¹⁾
Siemens	000	80A/690V: 3NE1 820-0 	

Size 

¹⁾ For the connection of an additional DC link capacitance or the parallel operation of up to five devices suitable, that means the DC link of several devices is connected with at the same time existent power supply connection of every device.



- Semiconductor fuses aR (device)
BM444X, design type NH

Bussmann	000	80A/690V: 170M1566 	100A/690V: 170M1567 
		125A/690V: 170M1568 	160A/690V: 170M1569 
	00	80A/1000V: 170M2680	100A/1000V: 170M2681
		125A/1000V: 170M2682	
	1	80A/690V: 170M3811 	100A/690V: 170M3812 
		125A/690V: 170M3813 	160A/690V: 170M3814  ¹⁾
SIBA	1	125A/690V: 2021120/125A ¹⁾	
Siemens	000	80A/690V: 3NE8 720-1 	100A/690V: 3NE8 721-1 
		125A/690V: 3NE8 722-1 	160A/690V: 3NE8 724-1 
	00	80A/690V: 3NE8 020-1 	100A/690V: 3NE8 021-1 
		125A/690V: 3NE8 022-1 	160A/690V: 3NE8 024-1 
	0	80A/1000V: 3NE4 120 	100A/1000V: 3NE4 121 
		125A/1000V: 3NE4 122 	
	1	100A/1000V: 3NE3 221 	125A/1000V: 3NE3 222 
		160A/1000V: 3NE3 224 	

Size 



- ¹⁾ For the connection of an additional DC link capacitance or the parallel operation of up to five devices suitable, that means the DC link of several devices is connected with at the same time existent power supply connection of every device.

- Full-range fuses gR and gS
BM4641, design type NH

SIBA	1	100A/690V: 2021134.100 
Siemens	00	125A/690V: 3NE1022-2 

Size 

- Semiconductor fuses aR (device)
BM4641, design type NH

Bussmann	000	200A/690V: 170M1570D 
Ferraz Shawmut	00	160A/690V: NH00GS69V16PV
SIBA	00C/80	160A/690V: 2028220.160 
Siemens	00	125A/690V: 3NE8022-1 





Size 

- Full-range fuses gR and gS
BM4642, design type NH

Siemens	00	125A/690V: 3NE1022-2 
---------	----	--

Size 









- Semiconductor fuses aR (device)
BM4642, design type NH

Bussmann	000	200A/690V: 170M1570D 
Ferraz Shawmut	00	160A/690V: NH00GS69V16PV
SIBA	00C/80	200A/690V: 2028220.200 
	1	250A/690V: 2021120.250 
Siemens	00	160A/690V: 3NE8024-1 

Size 

11.2.5 Fuses BM4X5X

















- Full-range fuses gR and gS
BM445X, design type NH

Bussmann	00	100A/690V: 170M2700	125A/690V: 170M2701
		160A/690V: 170M2702	
	1	125A/690V: 170M4180	160A/690V: 170M4181
		200A/690V: 170M4182 ¹⁾	250A/690V: 170M4183 ¹⁾
	2	200A/690V: 170M5881	250A/690V: 170M5882 ¹⁾
		315A/690V: 170M5883 ¹⁾	
3	350A/690V: 170M6080 ¹⁾		
Ferraz Shawmut	000	100A/690V: 6,9 GGR 000 PV 100	
	00	100A/690V: 6,9 GGR 00 PV 100	
		125A/690V: 6,9 GGR 00 PV 125 ¹⁾	
		160A/690V: 6,9 GGR 00 PV 160 ¹⁾	
SIBA	00	100A/690V: 2020934/100A _c  _{US}	125A/690V: 2020934/125A _c  _{US} ¹⁾
		1	100A/690V: 2021134/100A _c  _{US}
	1	160A/690V: 2021134/160A _c  _{US} ¹⁾	200A/690V: 2021134/200A _c  _{US} ¹⁾
		2	160A/690V: 2021234/160A _c  _{US} ¹⁾
Siemens	00	100A/690V: 3NE1 021-0  _{US}	125A/690V: 3NE1 022-0  _{US} ¹⁾
	1	160A/690V: 3NE1 224-0  _{US} ¹⁾	200A/690V: 3NE1 225-0  _{US} ¹⁾

Size ↑

¹⁾ For the connection of an additional DC link capacitance or the parallel operation of up to five devices suitable, that means the DC link of several devices is connected with at the same time existent power supply connection of every device.



- Semiconductor fuses aR (device)
BM445X, design type NH

Bussmann	000	125A/660V: 170M1568 	160A/660V: 170M1569 
		200A/660V: 170M1570 	250A/660V: 170M1571  ¹⁾
		315A/660V: 170M1572  ¹⁾	
	00	125A/1000V: 170M2682	160A/1000V: 170M2683 ¹⁾
		200A/900V: 170M2684 ¹⁾	225A/900V: 170M2685 ¹⁾
	1	160A/660V: 170M3814	200A/660V: 170M3815
		250A/660V: 170M3816	315A/660V: 170M3817 ¹⁾
		350A/660V: 170M3818 ¹⁾	400A/660V: 170M3819 ¹⁾
	2	400A/660V: 170M5808 ¹⁾	450A/660V: 170M5809 ¹⁾
	3	500A/660V: 170M6808 ¹⁾	
Ferraz Shawmut	000	125A/690V: 6,9 URD 000 PV 0125	
		160A/690V: 6,9 URD 000 PV 0160	
		200A/690V: 6,9 URD 000 PV 0200	
		250A/690V: 6,9 URD 000 PV 0250 ¹⁾	
		315A/690V: 6,9 URD 000 PV 0315 ¹⁾	
Siemens	00	125A/660V: 3NE8 022 c  _{us}	125A/660V: 3NE8 722
		160A/660V: 3NE8 024	160A/660V: 3NE8 724
		200A/660V: 3NE8 725	250A/660V: 3NE8 727 ¹⁾
		315A/660V: 3NE8 731 ¹⁾	
	0	100A/1000V: 3NE4 121 c  _{us}	125A/1000V: 3NE4 122 c  _{us}
		160A/1000V: 3NE4 124 c  _{us}	
	1	125A/1000V: 3NE3 222 c  _{us}	160A/1000V: 3NE3 224 c  _{us}
		200A/1000V: 3NE3 225 c  _{us}	250A/1000V: 3NE3 227 c  _{us} ¹⁾
		315A/1000V: 3NE3 230-0Bc  _{us} ¹⁾	350A/1000V: 3NE3 231 c  _{us} ¹⁾
		400A/1000V: 3NE3 232-0Bc  _{us} ¹⁾	
	2	400A/1000V: 3NE3 332-0Bc  _{us} ¹⁾	

Size 



¹⁾ For the connection of an additional DC link capacitance or the parallel operation of up to five devices suitable, that means the DC link of several devices is connected with at the same time existent power supply connection of every device.

- Full-range fuses gR and gS
BM4650, design type NH

SIBA	1	160A/690V: 2021134.160 c 
Siemens	1	200A/690V: 3NE1225-2 c 



Size _____ ↗

- Semiconductor fuses aR (device)
BM4650, design type NH

Bussmann	00	315A/690V: 170M1572D c 
Ferraz Shawmut	1	250A/690V: NH1GS69V250PV
SIBA	00C/80	315A/690V: 2028220.315 c 
Siemens	1/110	200A/1000V: 3NE3225 c 



Size _____ ↗

- Full-range fuses gR and gS
BM4651, design type NH

SIBA	1	200A/690V: 2021134.200 c 
Siemens	1	250A/690V: 3NE1227-2 c 

Size _____ ↗

- Semiconductor fuses aR (device)
BM4651, design type NH

Bussmann	00	315A/690V: 170M1572D c 
Ferraz Shawmut	1	250A/690V: NH1GS69V250PV
SIBA	00C/80	350A/690V: 2018920.350 c 
Siemens	1/110	250A/1000V: 3NE3227 c 

Size _____ ↗

- Full-range fuses gR and gS
BM4652, design type NH

Siemens	1	250A/690V: 3NE1227-2 
---------	---	--

Size \longrightarrow \uparrow

- Semiconductor fuses aR (device)
BM4652, design type NH

Bussmann	00	315A/690V: 170M1572D 	
Ferraz Shawmut	2	315A/690V: NH2GS69V315PV	
SIBA	1	315A/690V: 2021120.315 	
	00C/80	400A/690V: 2018920.400 	
Siemens	1/110	315A/1000V: 3NE3230-0B 	450A/1000V: 3NE3233 

Size \longrightarrow \uparrow









- Semiconductor fuses aR (device)
BM4755, design type NH



NOTE!

The semiconductor fuses can be used for the device BM4755 provided that:









- The total DC link capacitance of all connected devices is lower than 20 mF
- The used mains filter and power choke fulfill the Baumüller specifications.

Bussmann	1	350A/660V: 170M3818 	
	2	400A/660V: 170M5808 	450A/660V: 170M5809 
	3	500A/660V: 170M6808 	
SIBA	00	350A/690V: 2018920.350 	
Siemens	00	315A/1000V: 3NE8731-1 	
	1	315A/1000V: 3NE3230-0B 	350A/1000V: 3NE3231 

Size \longrightarrow \uparrow

11.2.6 Fuses BM4X6X



- Full-range fuses gR and gS
BM446X, design type NH

Bussmann	1	250A/690V: 170M4183	315A/690V: 170M4184 ¹⁾
		350A/690V: 170M4185 ¹⁾	400A/690V: 170M4186 ¹⁾
	2	250A/690V: 170M5882	315A/690V: 170M5883 ¹⁾
		350A/690V: 170M5884 ¹⁾	400A/690V: 170M5885 ¹⁾
		450A/690V: 170M5886 ¹⁾	
	3	350A/690V: 170M6080 ¹⁾	400A/690V: 170M6081 ¹⁾
450A/690V: 170M6082 ¹⁾			
SIBA	1	250A/690V: 2021134/250A _c  ¹⁾	315A/690V: 2021134/315A _c  ¹⁾
		350A/690V: 2021234/350A _c  ¹⁾	
	2	250A/690V: 2021234/250A _c  ¹⁾	315A/690V: 2021234/315A _c  ¹⁾
		350A/690V: 2021234/350A _c  ¹⁾	
3	315A/690V: 2021334/315A ¹⁾	350A/690V: 2021334/350A ¹⁾	
Siemens	1	250A/690V: 3NE1 227-0 c  ¹⁾	315A/690V: 3NE1 230-0 c  ¹⁾









Size 

- ¹⁾ For the connection of an additional DC link capacitance or the parallel operation of up to five devices suitable, that means the DC link of several devices is connected with at the same time existent power supply connection of every device.

- Semiconductor fuses aR (device) BM446X, design type NH

Bussmann	000	250A/660V: 170M1571 	315A/660V: 170M1572 
	00	225A/900V: 170M2685 ¹⁾	
	1	250A/660V: 170M3816	315A/660V: 170M3817
		350A/660V: 170M3818	400A/660V: 170M3819 ¹⁾
	2	400A/660V: 170M5808	450A/660V: 170M5809 ¹⁾
		500A/660V: 170M5810 ¹⁾	550A/660V: 170M5811 ¹⁾
		630A/660V: 170M5812 ¹⁾	
	3	500A/660V: 170M6808	550A/660V: 170M6809 ¹⁾
		630A/660V: 170M6810 ¹⁾	700A/660V: 170M6811 ¹⁾

Size 



Ferraz Shawmut	000	250A/690V: 6,9 URD 000 PV 0250	
		315A/690V: 6,9 URD 000 PV 0315	
	00	250A/690V: 6,9 URD 00 PV 0250	315A/690V: 6,9 URD 00 PV 0315
	0	250A/690V: 6,9 URD 0 PV 0250	315A/690V: 6,9 URD 0 PV 0315
	1	250A/690V: 6,9 URD 1 PV 0250	315A/690V: 6,9 URD 1 PV 0315
		350A/690V: 6,9 URD 1 PV 0350	400A/690V: 6,9 URD 1 PV 0400 ¹⁾
	2	250A/690V: 6,9 URD 2 PV 0250	315A/690V: 6,9 URD 2 PV 0315
		350A/690V: 6,9 URD 2 PV 0350	400A/690V: 6,9 URD 2 PV 0400
		450A/690V: 6,9 URD 2 PV 0450 ¹⁾	500A/690V: 6,9 URD 2 PV 0500 ¹⁾
		560A/690V: 6,9 URD 2 PV 0560 ¹⁾	630A/690V: 6,9 URD 2 PV 0630 ¹⁾
	3	315A/690V: 6,9 URD 3 PV 0315	350A/690V: 6,9 URD 3 PV 0350
		400A/690V: 6,9 URD 3 PV 0400	450A/690V: 6,9 URD 3 PV 0450
		500A/690V: 6,9 URD 3 PV 0500 ¹⁾	560A/690V: 6,9 URD 3 PV 0560 ¹⁾
		630A/690V: 6,9 URD 3 PV 0630 ¹⁾	700A/690V: 6,9 URD 3 PV 0700 ¹⁾
Siemens	00	250A/660V: 3NE8 727	315A/660V: 3NE8 731
	1	250A/1000V: 3NE3 227  ¹⁾	315A/1000V: 3NE3 230-0B  ¹⁾
		350A/1000V: 3NE3 231  ¹⁾	400A/1000V: 3NE3 232-0B  ¹⁾
		450A/1000V: 3NE3 233  ¹⁾	
	2	400A/1000V: 3NE3 332-0B  ¹⁾	450A/1000V: 3NE3 333  ¹⁾
		500A/1000V: 3NE3 334-0B  ¹⁾	560A/1000V: 3NE3 335  ¹⁾

Size _____ ▲

¹⁾ For the connection of an additional DC link capacitance or the parallel operation of up to five devices suitable, that means the DC link of several devices is connected with at the same time existent power supply connection of every device.





11.2 Fuses

- Full-range fuses gR and gS
BM4661, design type NH

SIBA	1	315A/690V: 2021134.315 c 
Siemens	1	315A/690V: 3NE1230-2 c 





Size _____ ↑

- Semiconductor fuses aR (device)
BM4661, design type NH

Bussmann	1	500A/690V: 170M4864D c 
		550A/690V: 170M5811D c 
Ferraz Shawmut	2	350A/690V: NH2GS69V350PV
SIBA	1/110	500A/690V: 2061331.500 c 
Siemens	1/110	400A/1000V: 3NE3232-0B c 





Size _____ ↑

- Full-range fuses gR and gS
BM4662, design type NH

SIBA	1	315A/690V: 2021134.315 c 	
	2	350A/690V: 2021134.350 c 	
Siemens	2	400A/690V: 3NE1332-2 c 	500A/690V: 3NE1334-2 c 

Size _____ ↑

- Semiconductor fuses aR (device)
BM4662, design type NH

Bussmann	2	550A/690V: 170M5811D c 
Ferraz Shawmut	2	400A/690V: NH2GS69V400PV
SIBA	1/110	630A/690V: 2061331.630 c 
Siemens	1/110	450A/1000V: 3NE3233 c 
	2/110	560A/1000V: 3NE3335 c 

Size _____ ↑





- Semiconductor fuses aR (device)
BM4766, design type NH



HINWEIS!

The semiconductor fuses can be used for the device BM4766 provided that:

- The total DC link capacitance of all connected devices is lower than 20 mF
- The used mains filter and power choke fulfill the Baumüller specifications.

Bussmann	2	500A/660V: 170M5810 
	3	550A/660V: 170M6809 
Ferraz Shawmut	2	500A/690V: 6,9URD2PV0500
	3	560A/690V: 6,9URD2PV0560
SIBA	1 / 110 mm	500A/690V: 2061331.500 
Siemens	1 / 110 mm	450A/1000V: 3NE3233 
	2	450A/1000V: 3NE3333 

Size



11.2.7 Fuses BM447X



DANGER!

Danger to life from electric current!

Parts, which are under tension are perilous. Damage in isolation or damage of single parts can be highly dangerous.

Therefore:

The use of semiconductor fuses is obligatory at the power supply connection of BM447X devices. Semiconductor fuses are required in the connection between brake resistor and device except the user assures the short-circuit protection of resistor and cable.

- Semiconductor fuses aR (device)
BM447X, design type NH

BM4472:

Siemens	2	500A/1000V: 3NE3 334-0B	560A/1000V: 3NE3 335
		710A/900V: 3NE3 337-8	

Size



NOTE

The 710 A fuse is recommended if the BM4472 is operated constantly at rated power and/or peak power is required frequently, because the 710 A fuse provides higher thermal reserve compared with 500A/560A fuses and therefore the risk of fuse tripping at normal run (without real error) is reduced.

BM4473, BM4773:

Siemens	2	800A/800V: 3NE3 338-8
---------	---	-----------------------

Size

11.2.8 UL fuse in the ballast circuit

BM445X, BM465X and BM4755:

Siemens	160A/700V: 3NE8 724-1 
---------	---

BM446X, BM466X and BM4766:

Siemens	250A/700V: 3NE8 727-1 
---------	---

BM447X, BM477X

Siemens	1	350A/1000V: 3NE3 231 
---------	---	--

Size 

11.2.9 24V extra-low voltage protection

In case you refer to UL 508 C:

Assure, that all marked e. l. v. connections (24 V) at the device have a maximum voltage of 30 V_{DC}. Additionally these connections must be protected with fuses which are in accordance with UL 248 with a triggering current of maximum 4 A.



HINWEIS!

If the current consumption is lower than 4 A, several connections can be protected together with a UL-listed fuse (release current max. 4 A).

11.3 Mains filters

Line filters are combinations of capacitors, chokes, resistors and voltage limiters, which reduce the electromagnetic influence of environment. Further information refer to Instruction handbook Mains Filter BFN, 5.09010.

11.3.1 Block diagram of filter for mains applications (simplified)

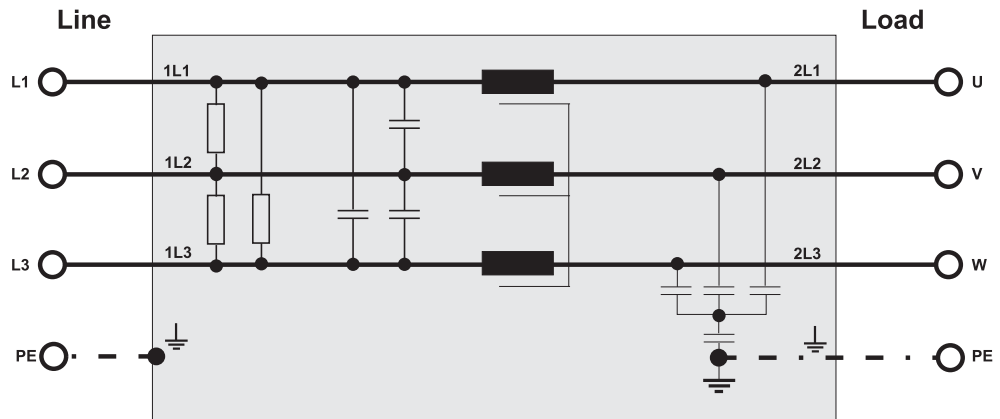

11.3.2 Baumüller mains filter type code

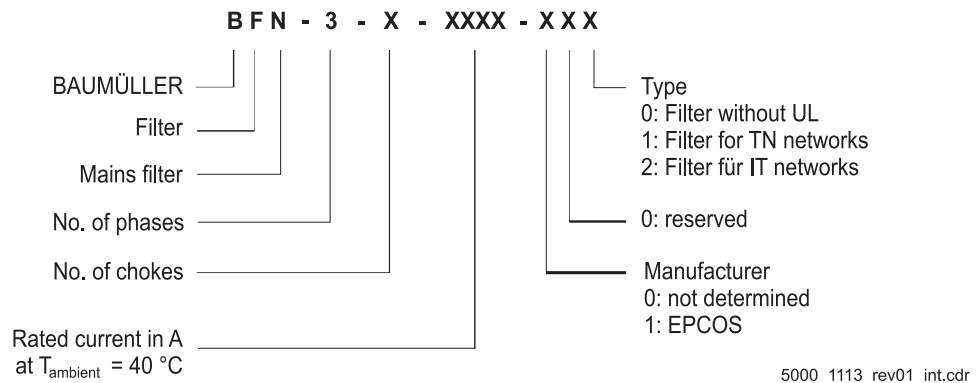

Figure 110: Mains filter type code

11.3.3 Required mains filter environmental conditions

Transport temperature range	-25 °C to +85 °C
Storage temperature range	-25 °C to +85 °C
Operating environment	Outside of residential areas
Operating temperature range	-25 °C to +85 °C (rated temperature 50 °C)

11.3.4 Electrical data mains filter

TN/TT systems

BFN 3-1-... -001	0007	0016	0030	0042	0056	0075	0100	0130	0180
Max. input supply voltage	3 x 480 V _{AC} +10 %, 50/60 Hz								
Rated current (at T _B = 50 °C)	7 A	16 A	30 A	42 A	56 A	75 A	100 A	130 A	180 A
Peak current (at T _B = 50 °C)	1.5 x I _N for < 1 min per hour								
Current derating	$I = I_{\text{rated}} \cdot \sqrt{85 - \frac{\vartheta_{\text{ambient}}}{35^{\circ}\text{C}}}$								
Test voltage	line - line: 2125 V _{DC} / 2 s line - housing: 2125 V _{DC} / 2 s								
Connection	L1/L2/L3: safe-to-touch screw terminals PE connection: bolt M5 / M6 / M10								
Maximum connection cross-section	4 mm ²	4 mm ²	10 mm ²	10 mm ²	16 mm ²	25 mm ²	50 mm ²	50 mm ²	95 mm ²
Power loss (typical)	4 W	8 W	12 W	15 W	18 W	24 W	24 W	30 W	35 W
Protection class	IP 20								

EPCOS	B84143A0150R410
Max. input supply voltage	3 x 480 V _{AC} +10 %, 50/60 Hz
Rated current (at T _B = 50 °C)	150 A
Peak current (at T _B = 50 °C)	1.5 x I _N for < 1 min per hour 2.5 x I _N for < 1 min per hour
Test voltage	line - line: 2240 V _{DC} / 2 s line - housing: 2720 V _{DC} / 2 s
Connection	L1/L2/L3: safe-to-touch screw terminals PE: bolt M10
Maximum connection cross-section	95 mm ²
Protection class	IP 20

11.3 Mains filters

BFN 3-1-... -001	0250	0320	0400	0600
Max. input supply voltage	3 x 480 V _{AC} +10 %, 50/60 Hz			
Rated current (at T _B = 50 °C)	250 A	320 A	400 A	600 A
Peak current (at T _B = 50 °C)	4 x I _N when switching on 1.5 x I _N for < 1 min / once per hour			
Test voltage	line - line: 2150 V _{DC} / 2 s line - housing: 2700 V _{DC} / 2 s			
Connection	bolt M10	bar with hole Ø 11mm PE: bolt M12		
Power loss (typical)	60 W	40 W	50 W	65 W
Protection class	IP 00			

BFN 3-1-... -101	0320	0400	0600	1000
Max. input supply voltage	3 x 480 V _{AC} +10 %, 50/60 Hz			
Rated current (at T _B = 50 °C)	320 A	400 A	600 A	1000 A
Peak current (at T _B = 50 °C)	1.5 x I _N for < 3 min per hour or 2.5 x I _N for 30 s per hour			
Test voltage	line - line: 2280 V _{DC} / 2 s line - housing: 2690 V _{DC} / 2 s			
Connection	bar with hole Ø 11mm PE: bolt M10			bar with hole Ø 14mm PE: bolt M12
Power loss (typical)	31 W	48 W	84 W	
Protection class	IP 00			

**Filter for
IT systems**

BFN 3-1-... -002	150	0250	0320	0400	0600
Max. input supply voltage	3 x 480 V _{AC} +10 %, 50/60 Hz				
Rated current (at T _B = 50 °C)	150 A	250 A	320 A	400 A	600 A
Peak current (at T _B = 50 °C)	4 x I _N when switching on 1.5 x I _N for < 1 min / once per hour				
Test voltage	line - line: 2150 V _{DC} / 2 s line - housing: 2700 V _{DC} / 2 s				
Connection	bolt M10		bar with hole ∅ 11mm PE: bolt M12	bar with hole ∅ 11mm PE: bolt M12	bar with hole ∅ 11mm PE: bolt M12
Power loss (typical)	30 W	60 W	40 W	50 W	65 W
Protection class	IP 00				

BFN 3-1-... -102	0320	0400	0600	1000
Max. input supply voltage	3 x 480 V _{AC} +10 %, 50/60 Hz			
Rated current (at T _B = 50 °C)	320 A	400 A	600 A	1000 A
Peak current (at T _B = 50 °C)	1.5 x I _N for < 3 min per hour or 2.5 x I _N for 30 s per hour			
Test voltage	line - line: 2280 V _{DC} / 2 s line - housing: 2690 V _{DC} / 2 s			
Connection	bar with hole ∅ 11mm PE: bolt M10			bar with hole ∅ 14mm PE: bolt M12
Power loss (typical)	31 W	48 W	84 W	
Protection class	IP 00			

DANGER!
Risk of fatal injury due to high leakage current!

Therefore:

- The cross-section of the protective ground conductor must be at least 10 mm² (EN 61800-5-1, Chapter 4.3.5.5.2).

11.3.5 Mains filter selection



NOTE!

The rated current of the filters that are used must be larger than or have same RMS-value as the actual power supply current (actual power supply current = RMS-value of the power supply current during the entire cycle time of the drive). During short-time operation (S3), the RMS-value is calculated as follows:

$$I_{\text{rms}} = \sqrt{\frac{1}{T} \int_0^T i^2 dt}$$

TT/TN system

$I_{\text{rated AC}}^{1)}$	Typ	Part No.
7 A	BFN-3-1 - 0007 - 001	314277
16 A	BFN-3-1 - 0016 - 001	314278
30 A	BFN-3-1 - 0030 - 001	314279
42 A	BFN-3-1 - 0042 - 001	314280
56 A	BFN-3-1 - 0056 - 001	314281
75 A	BFN-3-1 - 0075 - 001	314282
100 A	BFN-3-1 - 0100 - 001	314283
130 A	BFN-3-1 - 0130 - 001	314284
150 A	EPCOS B84143A0150R410	437618
180 A	BFN-3-1 - 0180 - 001	314285
250 A	BFN-3-1 - 0250 - 001	373891
320 A	BFN-3-1 - 0320 - 001	439384
	BFN-3-1 - 0320 - 101	373896
400 A	BFN-3-1 - 0400 - 001	373900
600 A	BFN-3-1 - 0600 - 001	373901
	BFN-3-1 - 0600 - 101	419997
1000 A	BFN-3-1 - 1000 - 101	423683

¹⁾ Rated temperature = 50° C

IT system

I_{rated AC} ¹⁾	Typ	Part No.
150 A	BFN-3-1 - 0150 - 002	433177
250 A	BFN-3-1 - 250 - 002	373620
320 A	BFN-3-1 - 320 - 002	373894
	BFN-3-1 - 320 - 102	439387
400 A	BFN-3-1 - 400 - 002	373898
600 A	BFN-3-1 - 600 - 002	373902
	BFN-3-1 - 600 - 102	439388

¹⁾ Rated temperature = 50° C

11.4 Power chokes

**NOTE!**

No power chokes are necessary for the devices BM441X, BM4422, BM4423, BM4424 and BM4425.

UL certified power chokes must be used in UL compliant machines/systems.

Current

Select the power chokes dependent upon your application and based on the input rated current. Take into account that the max. input current of the chokes may not lead to saturation.

Inductance

Select the power chokes depending on the short-circuit voltage of the power supply, so that the required inductance of the power supply refer to [►Requirements to the energy supply / supply system◄](#) on page 54 is adhered to.

**NOTE**

There is a different short-circuit voltage with the same choke at 60 Hz than there is at 50 Hz; according to the formula $u_k = (\omega L \cdot I_N \cdot \sqrt{3}) / U_N$ (with $\omega = 2\pi \cdot f$) the short-circuit voltage that would result at another power supply frequency can be calculated.

**NOTE**

The rated inductance is constant up to 1.1 times of rated current. You can expect that the inductance is reduced, if the current flow through the commutation choke is higher than this value. If it is important for the application, that the commutation inductance is equal its rated value when for longer time (e. g. with 30 s or 60 s) peak current at peak power is needed, chose a commutation choke with a peak current smaller or equal of the 1.1 times of the rated value of the commutation choke.

If you have any doubt selecting a commutation choke for a specific application, please contact the responsible sales representative of Baumüller.

**NOTE**

At installation heights higher than 1000 m above MSL the current must be reduced for 10 % per 1000 m.

At operation temperatures from 40 °C up to 55 °C the current must be reduced for 1 % per °C

Power choke type code

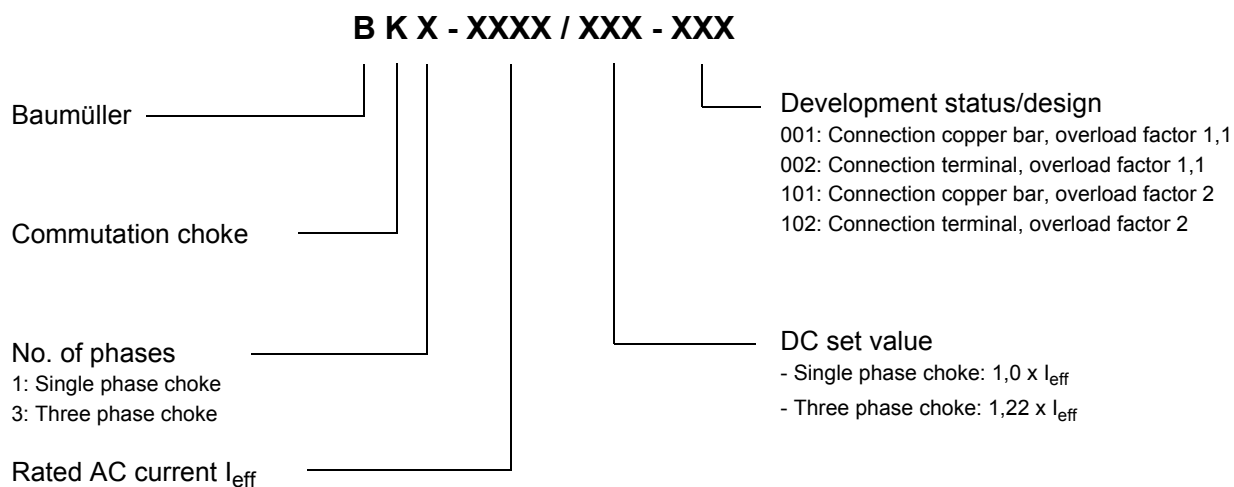



Figure 111: Type code power choke

The listed chokes are specified for the operation at 400 V / 50 Hz or 480 V / 60 Hz. At a power supply voltage of 400 V and a frequency of 50 Hz at rated current the chokes have a short-circuit voltage > 3% of the power supply voltage.

UL approval

The chokes are design-tested in accordance with UL (e.g. UL1561) and signified by the  symbol.

$I_{rated\ AC}$	Induc- tance	Type code	Part No. type -101, connection copper bar	Part No. type -102, connection terminal	For devices
24 A	1,22 mH	BK3-0024/0029	-	456715	BM4426
53 A	0,55 mH	BK3-0053/0070	-	456717	BM4632
82 A	0,36 mH	BK3-0082/0100	-	456718	BM4641
95 A	0,31 mH	BK3-0095/0116	-	456720	BM4642
125 A	0,23 mH	BK3-0125/0153	-	456722	BM4650
160 A	0,18 mH	BK3-0160/0196	-	456723	BM4651
190 A	0,15 mH	BK3-0190/0232	456725	-	BM4652
240 A	0,12 mH	BK3-0240/0294	456728	-	BM4661
285 A	0,10 mH	BK3-0285/0350	456729	-	BM4662

11.4 Power chokes

$I_{\text{rated AC}}$	Induc- tance	Type code	Part No. type -001, connection copper bar	Part No. type -002, connection terminal	For devices operation with peak current	For devices operation with rated current
25 A	1.18 mH	BK3-0025/0030	368377	399136	-	BM4432, BM4433
40 A	0.72 mH	BK3-0040/0050	368378	399137	BM4432, BM4433	BM4434
65 A	0.45 mH	BK3-0065/0080	368379	399138	BM4434, BM4435	BM4435
80 A	0.36 mH	BK3-0080/0100	368380	399139	-	BM4443
115 A	0.26 mH	BK3-0115/0140	368381	399140	BM4443, BM4444	BM4444, BM4445, BM4452
165 A	0.18 mH	BK3-0165/0200	368382	399141	BM4445, BM4452	BM4446, BM4453
195 A	0.15 mH	BK3-0195/0240	368383	-	BM4446, BM4453	BM4755
275 A	105 μ H	BK3-0275/0340	368384	-	BM4454	BM4454, BM4462
365 A	80 μ H	BK3-0365/0450	368385	-	BM4462, BM4463, BM4755	BM4463, BM4466, BM4766
450 A	65 μ H	BK3-0450/0550	368386	-	BM4466, BM4766	-
530 A	55 μ H	BK3-0530/0650	368387	-	-	BM4472
615 A	48 μ H	BK3-0615/0750	368388	-	BM4472	-
750 A	39 μ H	BK3-0750/0920	368389	-	-	BM4473, BM4773
920 A	32.6 μ H	BK3-0900/1100	368390	-	BM4473, BM4773	-
1020 A	28 μ H	BK3-1020/1250	395020	-	-	-

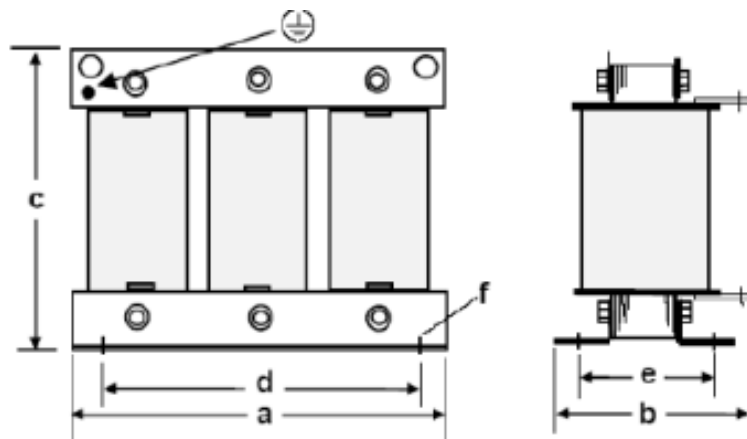

Figure 112: Figure power choke

BK3-	Part No.	I _{AC} [A]	I _{DC} [A]	a mm	b mm	c mm	d mm	e mm	f × g mm	Weight kg	Flat connection Ø mm × mm
0024/0029-102	456715	24	29	155	95	155	130	72	8×12	6	Cage clamp 4 mm ²
0025/0030-001	368377	25	30	155	130	132	130	72	8×12	6	20×2 for M6
0040/0050-001	368378	41	50	190	120	158	170	58	8×12	7	20×2 for M6
0053/0070-102	456717	53	70	230	130	285	180	98	9×12	13	Cage clamp 10 mm ²
0065/0080-001	368379	66	80	190	140	158	170	78	8×12	10	20×2 for M6
0080/0100-001	368380	82	100	230	165	202	180	98	8×12	12	25×3 for M8
0082/0100-102	456718	82	100	230	175	225	180	122	9×12	20	20×3 for M8
0095/0116-102	456720	95	116	240	180	225	190	125	11×15	25	20×3 for M8
0115/0140-001	368381	115	140	230	190	202	180	122	8×12	18	25×3 for M10
0125/0153-102	456722	125	153	265	190	250	215	126	11×15	31	25×4 for M10
0160/0196-102	456723	160	196	300	210	285	240	123	11×25	37	25×4 for M10
0165/0200-001	368382	164	200	240	195	211	190	125	11×15	23	25×3 for M10
0190/0232-101	456725	190	232	300	220	285	240	135	11×25	42	25×4 for M10
0195/0240-001	368383	197	240	265	195	230	215	126	11×15	28	25×3 for M10
0240/0294-101	456728	240	294	360	225	330	310	125	11×30	52	40×5 for M12
0275/0340-001	368384	297	340	300	225	271	240	145	11×15	38	30×5 for M10
0285/0350-101	456729	285	350	360	255	330	310	155	11×30	69	40×5 for M12
0365/0450-001	368385	369	450	360	220	320	310	125	11×15	47	40×5 for M12
0450/0550-001	368386	451	550	360	260	320	310	140	11×15	58	50×5 for M12
0530/0650-001	368387	533	650	360	260	320	310	140	11×15	63	50×5 for M12
0615/0750-001	368388	615	750	420	285	375	370	151	11×15	68	60×5 for M12
0750/0920-001	368389	754	920	420	285	375	370	151	11×15	78	60×5 for M12
0900/1100-001	368390	902	1100	420	285	380	370	166	11×15	90	60×10 for M12
1020/1250-001	395020	1020	1250	420	330	380	370	181	11×15	115	60×10 for M12
1150/1400-001	408679	1150	1400	420	330	380	370	181	11×15	130	60×10 for M12
1270/1550-001	408698	1270	1550	480	350	430	430	210	13×18	135	60×10 for M12
1350/1650-001	408699	1350	1650	480	350	430	430	210	13×18	145	60×10 for M12
1430/1750-001	408700	1430	1750	480	350	430	430	210	13×18	150	60×10 for M12
1680/2050-001	408701	1680	2050	480	350	430	430	210	13×18	170	60×10 for M12

11.5 Baumüller accessories

11.5.1 Shielding clamp

Type	Part No.
Width 11 mm, for cable diameter up to 8 mm	00312171
Width 19 mm, for cable diameter 7 mm to 16 mm	00397366
Width 27 mm, for cable diameter 6 mm to 24 mm	00397375
Width 43 mm, for cable diameter 22 mm to 40 mm	00397376

11.5.2 Cable RS232



NOTE!

In case you don't use an optically decoupled interface cable, the cable shield has only to be connected to the connector housing at the controller connector.

The company Baumüller Nürnberg GmbH recommends the usage of optically decoupled transmitters (e.g. from the company Ratioplast part no. 901SV232C6095 and part no. 901SV232T6095)

Optically decoupled interface cable

Interface	Name	Length	Part No.
X1 (RS 232)	Programming cable	3 m	on request

Further lengths on request.

11.5.3 Toroidal cores

**NOTE**

The number of the toroidal cores must be increased depending on the core temperature when using the converter at low speed (<100 rpm) for a longer period or in case the motor is supplied at standstill.

The data sheets of the toroidal core are available as an internal download.

The cores are added to the corresponding converter when ordered.

Please contact Baumüller in case of not-listed combinations or motor types.

Following toroidal cores are recommended for combinations of motors and mono/axis units series **BM4400, BM4600, BM4700** :

- **without** active mains rectifier unit BM41XX/BM51XX

Type motor	Type toroidal core	Part No.	Number of recommended cores
DS/DA 160	M113	432023	2 cores
DA 180	M114	432022	2 cores
DS 200	M114	432022	3 cores
DA 225	M114	432022	3 cores
DA 280	M114	432022	4 cores

- **with** active mains rectifier unit BM41XX/BM51XX

Type motor	Type toroidal core	Part No.	Number of recommended cores
DS/DA 160	M683	434203	3 cores
DA 180	M684	434204	3 cores
DS 200	M684	434204	3 cores
DA 225	M684	434204	3 cores
DA 280	M684	434204	3 cores

11.5.4 Accessories Ethernet/EtherCAT®.

Available Ethernet connecting cables:
type: patch cable, STP

Type	Length [m]	Part No.
K-ETH-33-0-0,5	0.5	325160
K-ETH-33-0-01	1	325161
K-ETH-33-0-02	2	325162
K-ETH-33-0-03	3	325163
K-ETH-33-0-04	4	325317
K-ETH-33-0-05	5	325164
K-ETH-33-0-10	10	325165

Additional lengths upon request

Crossover package consisting of cross connector (part No. 365463) and Cat5 cable 0.5 m (part No. 325160)

Type	Part No.
K-ETH-CROSS-ADAPTER	365464

Modular connector, RJ45 female - RJ45 female, crossover, Cat5, shielded

Type	Part No.
K-ETH-CROSS-KUPPLUNG	365463

11.5.5 Accessories - CANopen®

- CANopen®-connection cables:

Type	Model	Length [m]	Part No.
BM4-CAN-K-31-01	RJ45-plug, male sub D con- nector	1	346568
BM4-CAN-K-31-02		2	On request
BM4-CAN-K-31-03		3	346571
BM4-CAN-K-31-05 / 10		5 / 10	On request
BM4-CAN-K-32-01	RJ45-plug, sub D female	1	346572
BM4-CAN-K-32-02		2	On request
BM4-CAN-K-32-03		3	346573
BM4-CAN-K-32-05 / 10		5	On request
BM4-CAN-K-33-01	RJ45-plug, RJ45-plug	1	346577
BM4-CAN-K-33-02		2	On request
BM4-CAN-K-33-03		3	On request
BM4-CAN-K-33-05		5	On request
BM4-CAN-K-33-10		10	On request

- **Terminated plug RJ45**
(Termination plug CAN, RJ45 with pin assignment according to CIA-standard, 120 Ω, 0.25 W)

Type	Part No.
BM4-CAN-T01	346408

11.5.6 Encoder cables

- Motor-side encoder plug

Type		Part no.
Encoder plug	12-pin	245147
	12-pin SpeedTec	448729
	17-pin	362601
	17-pin SpeedTec	448730

- Cable connector and accordingly encoder cable for resolver, sine-cosine encoder with Hiperface® interface and square wave incremental encoder
15-pin D-sub connector/12-pin encoder plug (assembled - alternatively trailing cable, length refer to selections, further lengths on request).

Length	Cable not trailing cable Part no.	Cable trailing cable Part no.	SpeedTec trailing cable Part no.
1 m	243601	-	448941
2 m	211338	-	448943
3 m	219333	246658	448944
4 m	231166	243379	448945
5 m	209879	239540	448948
6 m	220197	242954	448946
7 m	216455	-	448947
8 m	220429	239541	448949
10 m	210052	239542	448956
15 m	215716	239543	448961
20 m	218568	239544	448967
25 m	218569	239545	448970
30 m	217094	239546	448971
35 m	216444	239547	448973
40 m	217095	240520	448976
45 m	217567	240521	448978
50 m	217568	240522	448979
55 m	217569	244033	448981
60 m	217570	245484	448982
70 m	232088	-	-

Bold: preferred length

In case the cable is produced self, please use the instructions stated below:

1 Use the following materials:

- Cable: LIYCY 5 x (2 x 0.14) + 2 x 0.5 mm, Cu braiding with at least 85% opt. overlap
- D-sub connector. 15-pin, male
- Circular connector: 12-pin, female (e.g. Interconnectron)

2 Connect the cable shield with the cabinet of the circular connector and with the shield of the D-sub connector

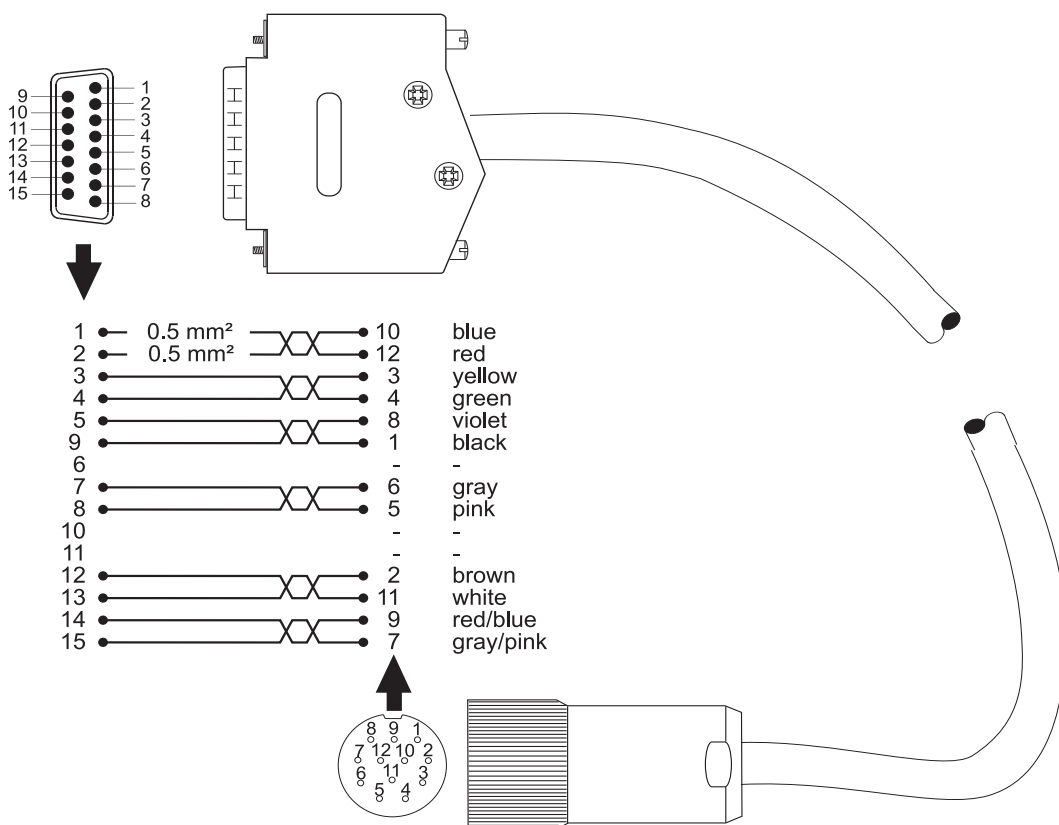

Figure 113: Cable connectors, 12-wire

NOTE



The cable connector must be produced according to the illustration which is shown above! In case there is another assignment of the pins, the cable will not operate and defects as well as at the encoder module and also at the encoder can appear!

- EnDat[®] 2.1 encoder cable
15-pin D-sub connector/12-pin encoder plug (assembled - alternatively trailing cable, length refer to selections, further lengths on request).

Length	Cable not trailing cable Part no.	Cable trailing cable Part no.	SpeedTec trailing cable Part no.
2 m	383152	393889	448816
3 m	383923	369864	448817
5 m	393885	394014	448818
7 m	389445	389807	448819
8 m	380138	393890	448820
9 m	389446	389808	448821
10 m	393886	393891	448822
15 m	388505	393892	448823
17 m	-	371494	448824
20 m	388418	393893	448825
25 m	393887	393894	448826
30 m	393888	380358	448827
35 m	387958	391216	448828
40 m	382006	382005	448830
50 m	388419	378022	-
70 m	384473	-	-
90 m	387391	-	-

Bold: preferred length



NOTE

With this encoder cables no evaluation of the motor temperature sensor is possible!

Use the instructions stated below, in order to make the cable self:”

1 Use the following materials:

- Cable: 14 wires (recommendation: 6 x (2 x 0.14mm²) + 2 x 0.5 mm²), twisted pairs, pairs layer-twisted, tinned Cu transfer, Cu braiding with at least 85% opt. overlap.
- D-sub connector. 15-pin, male
- Circular connector: 17-pin, female (e. g. Interconnectron)

2 Connect the cable shield laminar with the shield of the D-sub connector.

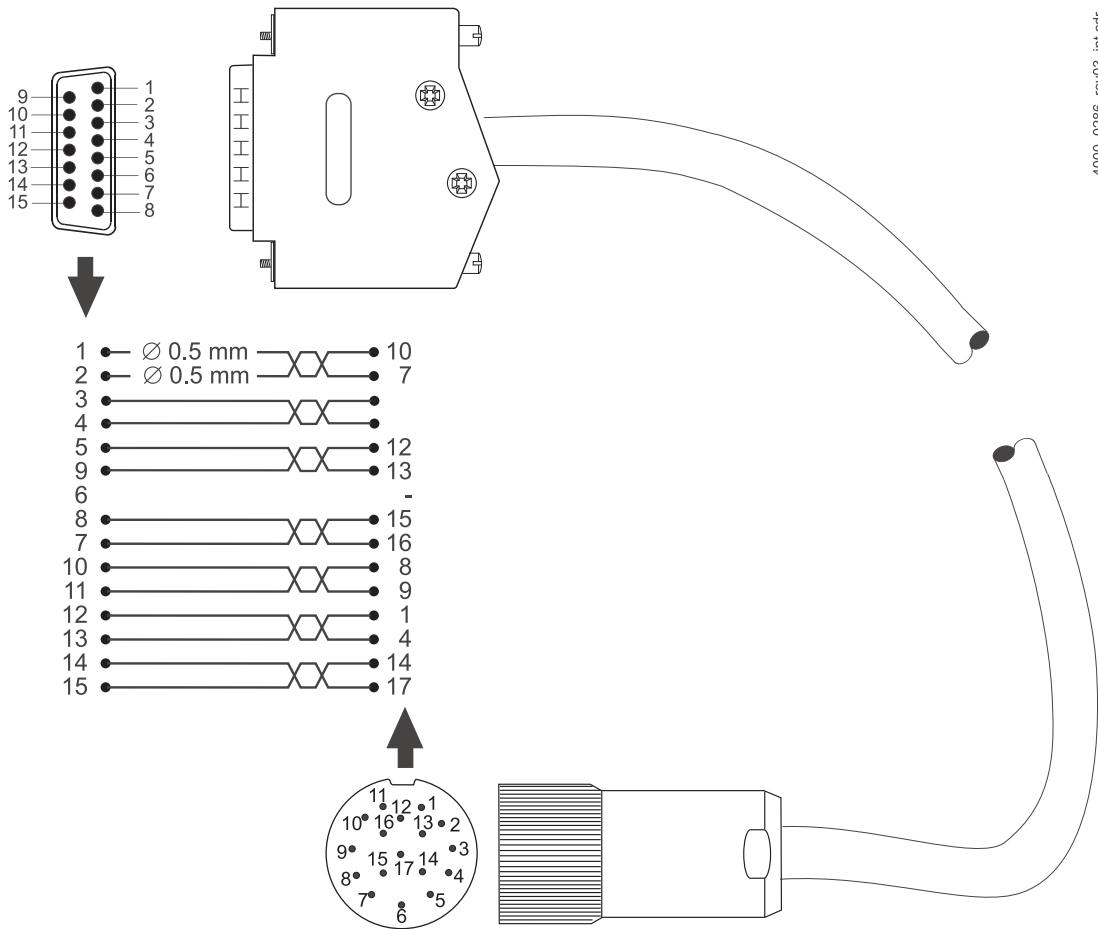

Figure 114: Cable connector for sine-cosine encoder with EnDat®-interface



NOTE

The cable connector must be produced according to the illustration which is shown above!

In case there is another assignment of the pins, the cable will not operate and defects as well as at the encoder module and also at the encoder can appear!

- EnDat 2.2[®] encoder cable without incremental signals
(original encoder cable of Fa. Heidenhain), lengths on request.

Cable with M12 connector 8-pin completely assembled with female connector plug and male D-sub connector.

Item no. Fa. Heidenhain

524599-xx (xx: length)

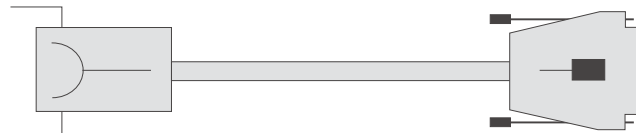

4000_0618_rev01_int

11.5.7 Design cover and connectors

	BM4412 BM4413 ¹⁾	BM4412 BM4413 ²⁾	BM4414 ¹⁾	BM4414 ²⁾	BM442X	BM443X, BM4463X	BM444X, BM4464X	BM445X, BM4465X, BM4475X	BM446X, BM4466X, BM4476X	BM447X, BM4477X	Part No.
Design cover (yellow) small	X	-	X	-	-	-	-	-	-	-	351209
Design cover (yellow) wide	-	X	-	X	X	X	X	X	X	X	351210
Connector „Motor“ Phoenix: GIC 2,5/4-ST-7,62, 1828825	X	X	X	X	-	-	-	-	-	-	354746
Connector „1C1/1D1“ or „1C1/1D1/Ba“ Phoenix: GIC 2,5/4-ST-7,62, 1828825	X	X	X	X	-	-	-	-	-	-	354746
Connector „Ba+/Ba-“ Phoenix: GIC 2,5/2-ST-7,62	-	-	X	X	-	-	-	-	-	-	381872
Connector „Power supply“ Phoenix: GMSTB 2,5/4-ST, 1766903 Wieland: 8313B/4 OBGN, 25.360.3453.7	X	X	X	X	-	-	-	-	-	-	309377
Connector X3 Phoenix: FK-MCP 1,5/6-ST-3,81, 1851083	X	X	X	X	X	X	X	X	X	X	354874
Connector X100 and X101 Wieland: 8513 BFK, 25.630.3653.0	X	X	X	X	X	X	X	X	X	X	354810
Connector X102³⁾⁴⁾ Phoenix: FK-MCP 1,5/4-ST-3,81, 1851067	-	-	-	-	-	X	X	X	X	X	363845
Wieland: 8513 BFK, 25.630.3453.7	X	X	X	X	X	-	-	-	-	-	354809
Connector X103⁴⁾ Phoenix: FK-MCP 1,5/4-ST-3,81, 1851067	-	-	-	-	-	X	X	X	X	X	363845

1) BM441X - XXX - 01

2) BM441X - XXX - 02

3) BM44XX - XX1, BM44XX - XX3

4) BM44XX - XX2, BM44XX - XX4

SHUTDOWN, STORAGE

In this chapter we describe, how you decommission and store the device.

12.1 Safety instructions

- Refer to [►Safety◄](#) from page 15 and the information in [►Transport and Packaging◄](#) from page 145.

The shutdown of the device may only be carried out by for this qualified personnel.



DANGER!

Risk of fatal injury from electrical current!

Stored electric charge.

Discharge time of the system = discharge time of the device with the longest DC link discharge time.

Therefore:

- Do not touch electrically live parts before taking into account the discharge time of the capacitors.
- Assure, that all electric connections are current-free and are safe against switch-on.
- Before working, check at the electrical connections with suitable measuring devices, that the connections are off-circuit.
- Remove the connections not until the safe isolation from supply has been checked.
- If additional capacitors are connected to the DC link, the DC link discharge can take a much longer time. In this case, the necessary waiting period must itself be determined or a measurement made as to whether the equipment is de-energized. This discharge time must be posted, together with an IEC 60417-5036 (2002-10) warning symbol, on a clearly visible location of the control cabinet.

12.2 Requirements to the executing personnel

The personnel, who is appointed to setting out of operation, must have the required knowledge and instructions, which is necessary for an execution according to the rules. Select the personnel in such a way, that the safety instructions, which are mounted to the device and its parts as well as to the connections, are understood and applied to.

12.3 Shutdown

Execute the setting out of operation as follows:

- 1 put the device off-circuit and assure the device against unintentional restart.
- 2 check the isolation from supply of all connections (earliest 10 minutes after switching off).
- 3 demount the connections and protect the connections according to the safety instructions.
- 4 document the shut down setting.

12.4 Demounting

The demounting assumes a completed, documented setting out of operation.



NOTICE!

Note sharp edges.

In case, while installing, you lift a device with unprotected hands, fingers/palm can be cut. If the device falls off, your feet can be cut up.

Therefore:

- Ensure that only qualified personnel, who are familiar with the safety notes and assembly instructions, demount this device.



Wear safety gloves.



- Wear safety shoes.

- 1 secure the device against falling off/out.
- 2 loosen all mechanical connections.
- 3 lift the device out of the control cabinet.
- 4 store the device in a suitable packing.
- 5 at transportation pay attention to, that the device is not damaged by wrong storage or severe shocks, also refer to [►What to observe when transporting◄](#) auf Seite 145.

In case you want to dispose the device, additional data is available in chapter [►Disposal◄](#) from page 325.

12.5 Storage conditions

The device is maintenance-free. If you keep to the environmental conditions during the entire period of storage, you can assume, that the device will not be damaged. In case the environmental conditions during storage are not kept, you should assume that the device is damaged after storage.



CAUTION!

Property damage because of incorrect storage conditions

Incorrect storage can damage/destroy the device.

Therefore:

Assure, that the environmental conditions are kept during the entire period of storage:

- Climatic category 1K4
- Temperature range -25 °C to +55 °C



CAUTION!

Recommissioning without forming of the capacitors.

From six months storage period on, the capacitors are destroyed during commissioning, if they are not formed beforehand

- Reform the DC link capacitors:
 - by supplying the device ready-to-operate for at least one hour with supply voltage
 - but do not transmit a pulse enable during this time.
- Consider, that it is imperative, to connect the accordingly prescribed line commutating reactor for this forming procedure. Devices, where no line commutating reactor is necessary can directly be supplied with mains voltage.

12.6 Recommissioning

Execute commissioning as with a new device, refer to [►Mounting◄](#) from page 147, [►Installation◄](#) from page 167.



CAUTION!

Recommissioning without forming of the capacitors.

From six months storage period on, the capacitors are destroyed during commissioning, if they are not formed beforehand

- Reform the DC link capacitors:
 - by supplying the device ready-to-operate for at least one hour with supply voltage
 - but do not transmit a pulse enable during this time.
- Consider, that it is imperative, to connect the accordingly prescribed line commutating reactor for this forming procedure. Devices, where no line commutating reactor is necessary can directly be supplied with mains voltage.

13

DISPOSAL



NOTE!

Baumüller products are not subject to the scope of application of the EU's Waste Electrical and Electronic Equipment Directive (WEEE, 2012/19/EU). Hence, Baumüller is not obligated to bear any costs for taking back and disposing of old devices.

13.1 Safety notes



DANGER!

Risk of fatal injury from electrical current!

Stored electric charge.

Discharge time of the system = discharge time of the device with the longest DC link discharge time in the DC link connection.

Refer to [►Electrical data basic units◄](#) from page 65.

Therefore:

- Do not touch before taking into account the discharge time of the capacitors and electrically live parts.
- Heed corresponding notes on the equipment.
- If additional capacitors are connected to the DC link, the DC link discharge can take a much longer time. In this case, the necessary waiting period must be determined or a measurement made as to whether the equipment is de-energized. This discharge time must be posted, together with an IEC 60417-5036 (2002-10) warning symbol, on a clearly visible location of the control cabinet.



CAUTION!

Danger due to sharp edges.

If the device is lifted with unprotected hands during deinstallation, palms or fingers can be cut. If the device falls, feet could be injured.

Therefore:

- Ensure that only qualified personnel, who are familiar with the safety notes and assembly instructions, mount this device.



Wear safety gloves.



Wear safety shoes.



WARNING!

Danger of physical impact!

Secure device against falling down.

Therefore:

- Take suitable measures, such as supports, hoists and assisting personnel, to ensure that device cannot fall down.
- Use appropriate means of transport.



NOTICE!

Avoid polluting the environment as a result of improper disposal.

Therefore:

- Only dispose in compliance with the health and safety regulations.
- Take heed of any special local regulations. If you are unable to directly ensure safe disposal yourself, commission a suitable disposal contractor.
- In the event of a fire, hazardous substances could possibly be generated or released.
- Do not expose electronic components to high temperatures.
- Beryllium oxide is used as inner insulation, for example for various power semiconductors. The beryllium dust that is generated upon opening is injurious to the health.
Do not open electronic components.
- Dispose of capacitors, semiconductor modules and electronic scrap as special waste.

**WARNING!****Danger as a result of faulty deinstallation!**

The deinstallation and disposal requires qualified personnel with adequate experience.

Therefore:

- Only allow deinstallation and disposal to be performed by qualified personnel.

13.2 Disposal facilities/authorities

Ensure that the disposal is handled in compliance with the disposal policies of your company, as well as with all national regulations of the responsible disposal facilities and authorities. In case of doubt, consult the bureau of commerce or environmental protection authority responsible for your company.



APPENDIX A - ABBREVIATIONS

A	Ampere	I_{set}	Current set value
AC	Alternating current	LT	Power unit
BB	Ready-to-operate	M24	Reference potential 24 V
BBext	Ready-to-operate (external)	MR1	Torque direction 1
BBint	Ready-to-operate (internal)	MR2	Torque direction 2
BSA	Reference potential analog	n = 0	Speed = 0
BSD	Reference potential digital	n_{ist}	Speed actual value
CiA	CAN in Automation	n_{max}	Maximum speed
DC	Direct current	n_{min}	Minimum speed
DIN	Deutsches Institut für Normung e.V. (German Institute for Standardization)	NN	Altitude over sea level
EMF	Electromotive force	n_{soll}	Speed set value
EMC	Electromagnetic compatibility	PE	Protective conductor
EN	European standard	PELV	Protective extra-low voltage with safety separation, earthed
ESD	Electrostatic discharge	RF	Controller enable
EXT, ext	external	SELV	Safety extra-low voltage with safety separation
FI	Residual current	SH	Quick stop
HS	Main contactor	SM	Synchronous motor
î	Peak current, curve shape not defined	TM	Motor temperature sensor
I_{AC}	Effective value, alternating current	U	Voltage
I_{Aist}	Armature current actual value	Û	Peak voltage
I_{DC}	Effective value, direct current	U_A	Armature voltage
I_{eff}	Effective value, alternating current	U_{AC}	Effective value, alternating voltage
IF	Pulse enable	U_{DC}	Effective value, direct-current voltage
I_F	Field current	U_{eff}	Effective value, alternating voltage
ID No.	Identification number	U_{ZK}	DC-link voltage
Ink	PPR count of incremental encoder	V	Volt
IS	Impulse inhibit	VDE	Association for Electrical, Electronic & Information Technologies
ISO	International Organization for Standardization	ZK	DC-link



APPENDIX B - INFORMATION ACCORDING EU Eco-DESIGN DIRECTIVE 2019/1781

Model	b maXX 5500				
Manufacturer	Baumüller				
Type	BM4412 -S- -A-	BM4413 -S- -A-	BM4414 -S- -A-		Operation point (% nominal output frequency; % nominal output current)
Power loss of output apparent power S_N	2.44	1.56	1.24	%	12;25
	2.66	1.81	1.24	%	12;50
	3.17	2.37	1.82	%	12;100
	2.48	1.59	1.27	%	50;25
	2.76	1.88	1.49	%	50;50
	3.45	2.55	1.98	%	50;100
	2.87	1.95	1.55	%	90;50
	3.74	2.75	2.14	%	90;100
Power loss in standby	18			W	
Efficiency level IEC61800-9-2	IE2				
Output apparent power	1.56	2.65	4.01	kVA	
Indicative nominal output power P_N	1.1	2	2.7	kW	
Nominal output current	2.5	4.5	5.5	A	
Maximum operation temperature	55			°C	
Nominal input frequency	50			Hz	
Nominal input voltage	400			V	

Model	b maXX 5500				
Manufacturer	Baumüller				
Type	BM4412 -C-	BM4413 -C-	BM4414 -C-		Operation point (% nominal output frequency; % nominal output current)
Power loss of output apparent power S_N	2.38	1.53	1.22	%	12;25
	2.60	1.77	1.22	%	12;50
	3.10	2.33	1.80	%	12;100
	2.42	1.55	1.24	%	50;25
	2.70	1.84	1.46	%	50;50
	3.38	2.52	1.96	%	50;100
	2.81	1.92	1.53	%	90;50
	3.67	2.71	2.12	%	90;100
Power loss in standby	17			W	
Efficiency level IEC61800-9-2	IE2				
Output apparent power	1.56	2.65	4.01	kVA	
Indicative nominal output power P_N	1.1	2	2.7	kW	
Nominal output current	2.5	4.5	5.5	A	
Maximum operation temperature	55			°C	
Nominal input frequency	50			Hz	
Nominal input voltage	400			V	

Model	b maXX 5500							
Manufacturer	Baumüller							Operation point (% nominal output frequency; % nominal output current)
Type	BM4422 -S-. -A-	BM4423 -S-. -A-	BM4424 -S-. -A-	BM4425 -S-. -A-	BM4426 -S-. -A-	BM4427 -S-. -A-		
Power loss of out- put apparent power S_N	0.92	0.82	0.82	0.82	0.60	0.51	%	12;25
	1.15	1.10	1.08	1.05	0.84	0.75	%	12;50
	1.68	1.75	1.70	1.58	1.40	1.32	%	12;100
	0.96	0.86	0.85	0.86	0.64	0.56	%	50;25
	1.24	0.23	1.20	1.16	0.96	0.87	%	50;50
	1.91	2.13	2.04	1.92	1.73	1.65	%	50;100
	1.33	1.38	1.33	1.30	1.06	0.94	%	90;50
	2.18	2.56	2.43	2.31	1.88	1.80	%	90;100
Power loss in standby	19.96							W
Efficiency level IEC61800-9-2	IE2							
Output apparent power	4.95	6.42	8.65	8.65	13.47	17.02		kVA
Indicative nominal output power P_N	3.4	5	6.8	6.8	10	11.5		kW
Nominal output current	7.5	11	15	15	22.5	27		A
Maximum opera- tion temperature	55							°C
Nominal input frequency	50							Hz
Nominal input voltage	400							V

Model	b maXX 5500							
Manufacturer	Baumüller							Operation point (% nominal output frequency; % nominal output current)
Type	BM4422 -F-. -Z-. -C-	BM4423 -F-. -Z-. -C-	BM4424 -F-. -Z-. -C-	BM4425 -F-. -Z-. -C-	BM4426 -F-. -Z-. -C-	BM4427 -F-. -Z-. -C-		
Power loss of out- put apparent power S_N	0.88	0.74	0.76	0.76	0.56	0.48	%	12;25
	1.10	1.02	1.03	0.99	0.80	0.72	%	12;50
	1.63	1.68	1.64	1.52	1.37	1.29	%	12;100
	0.91	0.78	0.80	0.80	0.61	0.53	%	50;25
	1.19	1.15	1.14	1.10	0.92	0.84	%	50;50
	1.86	2.05	1.98	1.86	1.69	1.62	%	50;100
	1.28	1.30	1.27	1.24	1.02	0.92	%	90;50
	2.13	2.48	2.37	2.25	1.85	1.77	%	90;100
Power loss in standby	17.56							W
Efficiency level IEC61800-9-2	IE2							
Output apparent power	4.95	6.42	8.65	8.65	13.47	17.02		kVA
Indicative nominal output power P_N	3.4	5	6.8	6.8	10	11.5		kW
Nominal output current	7.5	11	15	15	22.5	27		A
Maximum opera- tion temperature	55							°C
Nominal input frequency	50							Hz
Nominal input voltage	400							V

Supply system:
T. I. G

Model	b maXX 5500						
Manufacturer	Baumüller						Operation point (% nominal output frequency; % nominal output current)
Type	BM4432 -S-. -A-	BM4433 -S-. -A-	BM4434 -S-. -A-	BM4435 -S-. -A-	BM4632 -S-. -A-		
Power loss of out- put apparent power S_N	0.87	0.76	0.64	0.55	0.60	%	12;25
	1.10	0.99	0.87	0.76	0.84	%	12;50
	1.63	1.54	1.41	1.25	1.39	%	12;100
	0.91	0.80	0.69	0.58	0.63	%	50;25
	1.20	1.09	0.98	0.85	0.93	%	50;50
	1.89	1.78	1.68	1.46	1.63	%	50;100
	1.29	1.16	1.06	0.92	1.01	%	90;50
	2.04	1.92	1.83	1.62	1.83	%	90;100
Power loss in standby	54.67						W
Efficiency level IEC61800-9-2	IE2						
Output apparent power	17.55	13.64	27.38	38.23	34.14		kVA
Indicative nominal output power P_N	10	13	20	28	28		kW
Nominal output current	22.5	30	45	60	60		A
Maximum opera- tion temperature	55						°C
Nominal input frequency	50						Hz
Nominal input voltage	400						V

**Supply system:
T. I. G**

Model	b maXX 5500						
Manufacturer	Baumüller						Operation point (% nominal output frequency; % nominal output current)
Type	BM4432 -F-. -Z-. - C-	BM4433 -F-. -Z-. - C-	BM4434 -F-. -Z-. - C-	BM4435 -F-. -Z-. - C-	BM4632 -F-. -Z-. - C-		
Power loss of out- put apparent power S_N	0.70	0.62	0.56	0.49	0.53	%	12;25
	0.93	0.86	0.79	0.70	0.77	%	12;50
	1.46	1.40	1.32	1.19	1.32	%	12;100
	0.74	0.66	0.60	0.52	0.56	%	50;25
	1.03	0.95	0.89	0.78	0.86	%	50;50
	1.71	1.65	1.59	1.40	1.56	%	50;100
	1.11	1.02	0.97	0.86	0.94	%	90;50
	1.86	1.78	1.74	1.56	1.76	%	90;100
Power loss in standby	30.67						W
Efficiency level IEC61800-9-2	IE2						
Output apparent power	78.27	95.19	136.0	89.53	11.28		kVA
Indicative nominal output power P_N	53	75	110	58	82		kW
Nominal output current	120	150	210	130	165		A
Maximum opera- tion temperature	55						°C
Nominal input frequency	50						Hz
Nominal input voltage	400						V

Supply system:
T. I. G

Model	b maXX 5500							
Manufacturer	Baumüller							Operation point (% nominal output frequency; % nominal output current)
Type	BM4443 -S-. -A-	BM4444 -S-. -A-	BM4445 -S-. -A-	BM4446 -S-. -A-	BM4641 -S-. -A-	BM4642 -S-. -A-		
Power loss of out- put apparent power S_N	0.67	0.62	0.84	0.56	0.79	0.73	%	12;25
	0.96	0.84	1.12	0.80	1.01	0.97	%	12;50
	1.67	1.39	1.82	1.39	1.51	1.52	%	12;100
	0.73	0.67	0.90	0.60	0.83	0.78	%	50;25
	1.10	0.99	1.27	0.93	1.12	1.09	%	50;50
	2.06	1.80	2.22	1.73	1.79	1.83	%	50;100
	1.22	1.11	1.38	1.05	1.21	1.19	%	90;50
	2.25	2.02	2.42	1.94	1.97	2.02	%	90;100
Power loss in standby	158							W
Efficiency level IEC61800-9-2	IE2							
Output apparent power	49.22	58.37	74.45	104.0	60.84	68.44		kVA
Indicative nominal output power P_N	36	45	58	75	38	45		kW
Nominal output current	80	100	130	150	85	100		A
Maximum opera- tion temperature	55							°C
Nominal input frequency	50							Hz
Nominal input voltage	400							V

**Supply system:
T. I. G**

Model	b maXX 5500							
Manufacturer	Baumüller							Operation point (% nominal output frequency; % nominal output current)
Type	BM4443 -S-. -A- kurz	BM4444 -S-. -A- kurz	BM4445 -S-. -A- kurz	BM4446 -S-. -A- kurz	BM4641 -S-. -A- kurz	BM4642 -S-. -A- kurz		
Power loss of out- put apparent power S_N	0.58	0.54	0.78	0.51	0.71	0.67	%	12;25
	0.87	0.76	1.06	0.76	0.93	0.90	%	12;50
	1.58	1.31	1.76	1.35	1.44	1.45	%	12;100
	0.63	0.59	0.83	0.56	0.75	0.71	%	50;25
	1.01	0.91	1.21	0.88	1.04	1.02	%	50;50
	1.97	1.73	2.15	1.69	1.71	1.76	%	50;100
	1.13	1.04	1.32	1.0	1.13	1.12	%	90;50
	2.15	1.94	2.36	1.90	1.89	1.95	%	90;100
Power loss in standby	112							W
Efficiency level IEC61800-9-2	IE2							
Output apparent power	49.22	58.37	74.45	104.0	60.84	68.44	kVA	
Indicative nominal output power P_N	36	45	58	75	38	45	kW	
Nominal output current	80	100	130	150	85	100	A	
Maximum opera- tion temperature	55							°C
Nominal input frequency	50							Hz
Nominal input voltage	400							V

**Supply system:
T. I. G**

Model	b maXX 5500							
Manufacturer	Baumüller							Operation point (% nominal output frequency; % nominal output current)
Type	BM4443 -F-. -Z-	BM4444 -F-. -Z-	BM4445 -F-. -Z-	BM4446 -F-. -Z-	BM4641 -F-. -Z-	BM4642 -F-. -Z-		
Power loss of out- put apparent power S_N	0.47	1.45	0.71	0.46	0.62	0.59	%	12;25
	0.76	0.67	0.99	0.71	0.85	0.83	%	12;50
	1.47	1.22	1.68	1.29	1.35	1.37	%	12;100
	0.52	0.50	0.76	0.51	0.67	0.63	%	50;25
	0.90	0.82	1.13	0.83	0.96	0.95	%	50;50
	1.86	1.64	2.08	1.64	1.62	1.68	%	50;100
	1.02	0.94	1.25	0.95	1.04	1.04	%	90;50
	2.04	1.85	2.28	1.85	1.81	1.87	%	90;100
Power loss in standby	58							W
Efficiency level IEC61800-9-2	IE2							
Output apparent power	49.22	58.37	74.45	104.0	60.84	68.44		kVA
Indicative nominal output power P_N	36	45	58	75	38	45		kW
Nominal output current	80	100	130	150	85	100		A
Maximum opera- tion temperature	55							°C
Nominal input frequency	50							Hz
Nominal input voltage	400							V

**Supply system:
T. I. G**

Model	b maXX 5500							Operation point (% nominal output frequency; % nominal output current)
Manufacturer	Baumüller							
Type	BM4452 -S-. -A-	BM4453 -S-. -A-	BM4454 -S-. -A-	BM4650 -S-. -A-	BM4651 -S-. -A-	BM4652 -S-. -A-	BM4755 -S-. -A-	
Power loss of output apparent power S_N	0.83	0.73	0.60	0.78	0.65	0.58	0.65	% 12;25
	1.10	1.03	0.83	0.99	0.87	0.81	0.96	% 12;50
	1.76	1.76	1.43	1.50	1.38	1.37	1.76	% 12;100
	0.88	0.79	0.64	0.82	0.70	0.63	0.70	% 50;25
	1.24	1.19	0.98	1.12	0.98	0.94	1.10	% 50;50
	2.11	2.22	1.84	1.82	1.68	1.69	2.20	% 50;100
	1.34	1.33	1.12	1.20	1.08	1.04	1.17	% 90;50
	2.29	2.42	2.07	1.98	1.85	1.88	2.34	% 90;100
Power loss in standby	264							W
Efficiency level IEC61800-9-2	IE2							
Output apparent power	78.27	95.17	136.0	89.53	114.28	135.44	135.87	kVA
Indicative nominal output power P_N	53	75	110	58	82	104	138	kW
Nominal output current	120	150	210	130	165	200	260	A
Maximum operation temperature	55							°C
Nominal input frequency	50							Hz
Nominal input voltage	400							V

**Supply system:
T. I. G**

Model	b maXX 5500								Operation point (% nominal output frequency; % nominal output current)
Manufacturer	Baumüller								
Type	BM4452 -F-. -Z-	BM4453 -F-. -Z-	BM4454 -F-. -Z-	BM4650 -F-. -Z-	BM4651 -F-. -Z-	BM4652 -F-. -Z-	BM4755 -F-. -Z-		
Power loss of output apparent power S_N	0.56	0.51	0.44	0.54	0.47	0.43	0.49	%	12;25
	0.83	0.81	0.68	0.76	0.68	0.66	0.81	%	12;50
	1.49	1.54	1.28	1.27	1.20	1.21	1.60	%	12;100
	0.61	0.57	0.49	0.59	0.51	0.48	0.54	%	50;25
	0.97	0.97	0.83	0.88	0.80	0.79	0.95	%	50;50
	1.84	2.0	1.69	1.59	1.50	1.54	2.04	%	50;100
	1.07	1.11	0.97	0.97	0.90	0.89	1.02	%	90;50
	2.02	2.20	1.92	1.75	1.67	1.72	2.19	%	90;100
Power loss in standby	264								W
Efficiency level IEC61800-9-2	IE2								
Output apparent power	78.27	95.17	136.0	89.53	114.28	135.44	135.87	kVA	
Indicative nominal output power P_N	53	75	110	58	82	104	138	kW	
Nominal output current	120	150	210	130	165	200	260	A	
Maximum operation temperature	55								°C
Nominal input frequency	50								Hz
Nominal input voltage	400								V

**Supply system:
T. I. G**

Model	b maXX 5500							
Manufacturer	Baumüller							Operation point (% nominal output frequency; % nominal output current)
Type	BM4462 -S-. -A-	BM4463 -S-. -A-	BM4466 -S-. -A-	BM4661 -S-. -A-	BM4662 -S-. -A-	BM4766 -S-. -A-		
Power loss of out- put apparent power S_N	0.46	0.41	0.38	0.49	0.45	0.36	%	12;25
	0.71	0.67	0.63	0.68	0.69	0.60	%	12;50
	1.33	1.31	1.28	1.25	1.24	1.19	%	12;100
	0.52	0.48	0.43	0.54	0.50	0.40	%	50;25
	0.86	0.83	0.77	0.85	0.81	0.71	%	50;50
	1.76	1.77	1.66	1.59	1.56	1.51	%	50;100
	0.99	0.97	0.89	0.95	0.91	0.79	%	90;50
	1.94	1.97	0.84	1.76	1.73	1.68	%	90;100
Power loss in standby	155							W
Efficiency level IEC61800-9-2	IE2							
Output apparent power	165.02	201.67	240.28	170.67	200.51	316.16		kVA
Indicative nominal output power P_N	132	160	175	132	160	225		kW
Nominal output current	250	300	350	250	300	450		A
Maximum opera- tion temperature	55							°C
Nominal input frequency	50							Hz
Nominal input voltage	400							V

Supply system:
T. I. G

Model	b maXX 5500							
Manufacturer	Baumüller							Operation point (% nominal output frequency; % nominal output current)
Type	BM4462 -F-. -Z-	BM4463 -F-. -Z-	BM4466 -F-. -Z-	BM4661 -F-. -Z-	BM4662 -F-. -Z-	BM4766 -F-. -Z-		
Power loss of out- put apparent power S_N	0.41	0.37	0.34	0.44	0.41	0.33	%	12;25
	0.66	0.63	0.60	0.63	0.64	0.57	%	12;50
	1.28	1.27	1.25	1.20	1.19	1.16	%	12;100
	0.46	0.43	0.40	0.49	0.46	0.38	%	50;25
	0.81	0.78	0.74	0.80	0.77	0.69	%	50;50
	1.71	1.73	1.62	1.54	1.52	1.49	%	50;100
	0.94	0.93	0.85	0.90	0.86	0.76	%	90;50
	1.89	1.93	1.81	1.71	1.68	1.65	%	90;100
Power loss in standby	68							W
Efficiency level IEC61800-9-2	IE2							
Output apparent power	165.02	201.67	240.28	170.67	200.51	316.16		kVA
Indicative nominal output power P_N	132	160	175	132	160	225		kW
Nominal output current	250	300	350	250	300	450		A
Maximum opera- tion temperature	55							°C
Nominal input frequency	50							Hz
Nominal input voltage	400							V

Model	b maXX 5500								
Manufacturer	Baumüller							Operation point (% nominal output frequency; % nominal output current)	
Type	BM4472 -S-. -A-	BM4473 -S-. -A-	BM4774 -S-. -A-	BM4472 -F-. -Z-. -C-	BM4473 -F-. -Z-. -C-	BM4774 -F-. -Z-. -C-			
Power loss of out- put apparent power S_N	0.60	0.54	0.50	0.47	0.43	0.41	%	12;25	
	0.97	0.77	0.74	0.84	0.66	0.64	%	12;50	
	1.25	1.31	1.28	1.11	1.20	1.19	%	12;100	
	0.64	0.58	0.55	0.50	0.47	0.45	%	50;25	
	1.06	0.87	0.84	0.92	0.76	0.74	%	50;50	
	1.46	1.58	1.53	1.32	1.47	1.44	%	50;100	
	0.97	0.97	0.98	0.83	0.86	0.88	%	90;50	
	1.62	1.75	1.76	1.49	1.64	1.67	%	90;100	
Power loss in standby	662			212			W		
Efficiency level IEC61800-9-2	IE2								
Output apparent power	332.77	411.75	470.83	332.77	411.75	470.83	kVA		
Indicative nominal output power P_N	225	315	370	225	315	370	kW		
Nominal output current	450	615	720	450	615	720	A		
Maximum opera- tion temperature	55							°C	
Nominal input frequency	50							Hz	
Nominal input voltage	400							V	

**Supply system:
R.S. W**

Model	b maXX 5500										Operation point (% nominal output frequency; % nominal output current)
Manufacturer	Baumüller										
Type	BM4434 -S-. -A-	BM4435 -S-. -A-	BM4443 -S-. -A-	BM4645 -S-. -A-	BM4454 -S-. -A-	BM4462 -S-. -A-	BM4463 -S-. -A-	BM4466 -S-. -A-	BM4766 -S-. -A-		
Power loss of output apparent power S_N	0.60	0.47	0.64	0.70	0.59	0.63	0.56	0.41	0.39	%	12;25
	0.81	0.65	0.92	0.98	0.81	0.91	0.85	0.65	0.63	%	12;50
	1.32	1.08	1.60	1.63	1.34	1.59	1.57	1.26	1.22	%	12;100
	0.65	0.51	0.70	0.75	0.62	0.67	0.60	0.45	0.44	%	50;25
	0.96	0.76	1.07	1.10	0.88	1.01	0.96	0.77	0.75	%	50;50
	1.75	1.39	2.07	1.99	1.50	1.86	1.88	1.59	1.55	%	50;100
	1.15	0.91	1.25	1.22	0.97	1.09	1.05	0.88	0.84	%	90;50
	2.26	1.80	2.53	2.30	1.72	2.06	2.09	1.89	1.78	%	90;100
Power loss in standby	54.67		160.0		264.0	272.0				W	
Efficiency level IEC61800-9-2	IE2										
Output apparent power	29.59	45.20	51.95	78.49	136.0	138.44	168.22	249.74	316.89	kVA	
Indicative nominal output power P_N	20	28	36	58	110	132	160	175	225	kW	
Nominal output current	45	60	80	130	210	250	300	350	450	A	
Maximum operation temperature	55										°C
Nominal input frequency	50										Hz
Nominal input voltage	400										V



NOTE!

Following devices are excluded from the EU Eco-Design Directive 2019/1781:

Brand: Baumüller

Type: Power modules: BM44XX

Reasons:

The devices are not connected to a three-phase system.



APPENDIX C - DECLARATION OF CONFORMITY



EU - Declaration of Conformity

Doc.-No.

5.10065.08

Date:

08-Sep-2020

**according to EMC Directive 2014/30/EU and
Low Voltage Directive 2014/35/EU**

The Manufacturer: Baumüller Nürnberg GmbH
Ostendstraße 80-90
90482 Nürnberg, Germany

declares, that the products:

Brand name: Baumüller
Designation: b maXX 4400, b maXX 4600 and b maXX 4700 without safety relay
Type: BM4XXX-XXX-XX1XX, BM4XXX-XXX-XX2XX, BM4XXX-XXX-XX3XX
manufactured since: 30.11.2010

Designation: b maXX 4400 ES, b maXX 4600 ES and b maXX 4700 ES without safety relay
Type: BM4XXX-XXX-XX4XX, BM4XXX-XXX-XX5XX
manufactured since: 03.05.2013

are developed, designed and manufactured in accordance with the EMC Directive 2014/30/EU and the Low Voltage Directive 2014/35/EU.

Applied harmonized standards:

Standard	Title
DIN EN 62061:2005: 2016	Safety of machinery - Functional safety of safety-related electrical, electronic and programmable electronic control systems
DIN EN 61800-5-1:2017-11	Adjustable speed electrical power drive systems. Part 5-1: Safety requirements. Electrical, thermal and energy
DIN EN 61800-5-2:2017-11	Adjustable speed electrical power drive systems. Part 5-2: Safety requirements. Functional
DIN EN 61800-3:2019-04	Adjustable speed electrical power drive systems. Part 3: EMC requirements and specific test methods

Attention should be paid to the safety instructions in the manual.

Nuremberg / 08-Sep-2020

Location / Date

Subject to change of this declaration of EC conformity without notice. Actual valid edition on request.

be in motion be in motion be in motion



www.baumueller.com

EU - Declaration of Conformity**Doc.-No.****5.10065.06****Date:****09-Jan-2019****according to Machinery Directive 2006/42/EC**

The Manufacturer: Baumüller Nürnberg GmbH
Ostendstrasse 80-90
90482 Nuremberg, Germany

declares, that the products:

Brand name: Baumüller
Designation: b maXX 4400, b maXX 4600 and b maXX 4700 with safety relay
Type: BM4XXX-XXX-XX1XX, BM4XXX-XXX-XX2XX, BM4XXX-XXX-XX3XX
manufactured since: 30.11.2010

Designation: b maXX 4400 ES, b maXX 4600 ES and b maXX 4700 ES with safety relay
Type: BM4XXX-XXX-XX4XX, BM4XXX-XXX-XX5XX
manufactured since: 04.06.2013

are developed, designed and manufactured in accordance with the Machinery Directive 2006/42/EC. These products comply with the requirements of the EMC Directive 2014/30/EU and the Low Voltage Directive 2014/35/EU.

Applied harmonized standards:

Norm	Title
DIN EN 62061:2005 +AC:2010 + A1:2013 +A2:2016	Safety of machinery - Functional safety of safety-related electrical, electronic and programmable electronic control systems
EN ISO 13849-1:2015	Safety of machinery - Safety-related parts of control systems, Part 1: General principles for design
EN 61800-5-1:2007 +A1:2017	Adjustable speed electrical power drive systems Part 5-1: Safety requirements. Electrical, thermal and energy
EN 61800-5-2:2017	Adjustable speed electrical power drive systems Part 5-2: Safety requirements. Functional
EN 61800-3:2004 +A1:2012	Adjustable speed electrical power drive systems. Part 3: EMC requirements and specific test methods
IEC 61508, Teil 1-7: 2010	Functional safety of safety-related electrical, electronic and programmable electronic control systems

Authorized person to compile the technical files:

Name: Qian Chang, Baumüller Nürnberg GmbH, dept. CAL
Address: Ostendstraße 80-90, 90482 Nürnberg, Germany

Notified body executed the EC type-examination procedures according to Machinery Directive 2006/42/EC:

Name: TÜV Rheinland Industrie Service GmbH
Address: Am Grauen Stein, 51105 Köln / Germany
Identification number: 0035
Registration numbers: 01/205/5674/18

Attention should be paid to the safety instructions in the manual.

This product is to be used in machinery and must not put into operation until the machinery, into which it is incorporated, has been declared to be in conformity with the Machinery Directive 2006/42/EC.

Nuremberg / 09-Jan-2019

Location / Date

Subject to change of this declaration of EC conformity without notice. Actual valid edition on request.





APPENDIX D - SAFE STOP

In this chapter the safety function „Safe stop“ is described for **b maXX 4000**. This safety function is available for BM4400, BM4600 and BM4700.

D.1 Methods to avoid an unexpected starting

In order to avoid danger for persons, for example operators, service- and maintenance technicians, the machine must be kept in a safe state (safe stop), while taking action in the dangerous area of the machine. Therefore a reliable prevention of an unexpected starting is required (Machine Directive 2006/42/EG, attachment I, 1.2.4; EN ISO 12100-1; EN 60204-1, 5.4; EN 62061; EN 61800-5-2). Unexpected starting causes a risk for persons, because of its unexpected occurrence (EN 292-1).

Besides the transmission of the enable state into the operating state of the machine, the unexpected starting of the machine must be considered. This is the transmission from the safe stop into an unsafe moving. Unexpected starting refers to an interruption of the control loop of the machine. The drive achieves the maximum speed at maximum acceleration, due to its control. The operator will not be able to leave the danger area or to remove his hand from the danger area. Therefore, the drive must be kept safe „off-position“ with opened and electrical interlocked safety devices. The motor must be in torqueless state. Thus, the motor cannot generate a dangerous movement.

The prevention of an unexpected starting of the machine is reached with electrical separated safety devices, e.g. contactors.

This is not state of the art, because the conventional operation in the power circuit of the drive may cause unnecessary wear on the switching element and long response times in the machine.

Some machine types are not electrically isolated between the electrical connection of the drive and the power supply. If, for example, a drive supplied by a power converter is stopped and started again very often and in short intervals. The constant discharging and recharging of the DC link represents a great stress for the parts and leads to disturbing delays and early failures of the parts.

The integration of the protection function is more efficient for preventing an unexpected starting directly into the inverter. Here, the drive is not isolated from the power supply. However, the commutation of the power semiconductors is safety prevented in the inverter.

In Baumüller devices of the **b maXX 4000** type, this occurs by the safety relay, which switches the power supply off for the IGBT control.

In the Baumüller converters of **b maXX 4000** this is accomplished by the safety relay, which switches the power supply off for the IGBT control.

The device models are available with one safety relay (BM4000 size 1 - 7) or with two safety relays (BM4000, size 3 - 7). The version with one safety relay is shutdown path 1. The version with double safety relay are the shutdown paths 1 and 2.

For a safe two-channel shutdown with one safety relay, a second shutdown path at the Baumüller BM4000 controller LC3 is achieved via the pulse enable circuit of the controller. Additionally the pulses for the IGBT control are disabled at this circuit.

Refer to [▷D.2 Safe Torque Off \(STO\)◀](#) from page 354 for additional information.

Physical relationship

The precondition for starting an AC motor is the generation of a rotating field, which drives the armature of the motor. When having variable-speed AC current drives, in the microprocessors usually a complex pulse pattern is generated. Then the pulses are amplified and are used for switching the power semiconductors. If no defined pulse pattern is available or the amplifying connection is interrupted, e. g. by switching off the power supply with a relay (safety relay), then a rotary field cannot be generated. An error at the pulse pattern generation therefore cannot lead to a starting of the motor, as long as the second precondition, namely the interruption of the amplifying power supply is available and vice versa. The protection against unexpected starting is reached by an electromechanical method which is superior to the electronics. This is reached by a safe isolation, which is not executed in the load circuit.

Energy supply of the motor windings at a stop is reached by inhibiting the power semiconductors. Semiconductors can fail or can be started accidentally, due to electromagnetic interferences. The behavior of the shut down drive must be considered, in case of this error. The fail and the accidental switching on of a single or of several power semiconductors at the same DC-link pole, does not cause does not lead to an uncontrollable starting, as there is no current flow. If an additional power semiconductor is enabled at another pole, current is able to flow through the motor. If, thereby the DC link is directly short-circuited, the fuses which are upstreamed to the converter are tripped, the motor doesn't start. If the DC link is „short-circuited“ over a winding of the motor, a magnetic field can be set up in the motor. If it is an asynchronous motor, then the generated d. c. magnetic field cannot cause a movement of the rotor. By the permanent-magnetic synchronous motor the rotor will rotate into a notch position. The angular movement which is covered is dependable of the choke 's position and the number of pole pairs of the motor. It amounts to maximum 180° /number of pole pairs. Subsequently the enabled DC link operates like a brake, this means after the ending of the movement the drive is in a blocked state. A starting of the drive is impossible. If a machine with a synchronous motor is planned, the possible movement must be considered, because it can lead to a dangerous movement. Therefore the machine constructor must carry out a safety evaluation for the residual movement.

**NOTE**

At total failure of an internal driver (IGBT) or an control element, it can trigger a temporary excitation of the drive (also in the STO state).

If the link to a winding of the motor is „short-circuited“, a magnetic field develops in the motor. If this is an asynchronous motor, the generated DC field cannot effect a movement of the rotor.

The rotor in a permanently energized synchronous motor will rotate into a notch position. The angular movement depends on the rotor position and the number of pole pairs of the motor. It amounts to a maximum of $180^\circ/\text{number of pole pairs}$.

The possible movement must be considered, if a machine with a synchronous motor is developed.

**NOTE**

The function is limited to the prevention of an unexpected starting. The switching of the safety relay, while the rotor of the motor is rotating, causes an uncontrolled „coasting“ of the machine. Braking with the converter is not possible.

**DANGER!****Danger to life by electrical current!**

Power supply voltage can be present at the motor and at the device, if STO / Safe stop function is active.

Therefore:

- De-energize the device, as it would be done with a device without safety relay. The device and the motor is **not** de-energized by the safety relay!

**NOTE**

There is no isolation from the supply system if the function STO/Safe stop is activated. There can be potential at the converter and at the motor. In the case of maintenance-, service- and repair- works on electrical components of the drive system, protection against dangers must be provided by other means (e. g. main switch).



NOTE

If the safety relay is switched off, it is not possible to use a ballast switch at BM441X and BM442X.

D.2 Safe Torque Off (STO)

D.2.1 Safety classifications and safety notes

according to EN ISO 13849-1 and EN 62061

In combination with the Baumüller BM4000 controller LC3, the Baumüller b maXX converter BM4XXX-XXY-XXXXX[Ryy]-**S01**-xx provides the safety function STO (Safe Torque Off).

- The drive is without torque in STO function.
- The activation of the power amplifier is reliable disabled.
- The STO function fulfills the stop category 0 according EN 60204-1.

The drive stops after coasting, if there is no force at the drive shaft.

If STO function is selected, no danger will occur from the drive.

A starting of the drive without a disabling of the STO function is not possible.



NOTE

A device with safety relay is not a safe device. The device with safety relay does not comply with the PL level according to ISO 13849 and SIL according to EN 61800, if the part number **does not** start with „06“. This device is not certified for safety functions!



NOTE!

Devices with the approval mark of TÜV Rheinland and the Safety label provide a certified safety function, only, refer to [►Page 31◀](#).



The STO function meets the following classifications and standards:

1) Two-channel connection of the shutdown via 1 safety relay at the basic unit and the pulse enable channel of the BM4000-controller LC3:

Device models BM4XXX-XXY-XXXXX Ryy]-S01-XX
with Y= 1, 3 or 5 (devices with a safety relay):
Size 1, 2

- PL-d according to EN ISO 13849-1
with the following parameters:
 - Structure: cat 3
 - MTTFd: high (19026 a)
 - DC: low (60 % - 90 %)
- SIL 2 according to EN 62061 and EN 61508
with PFH = 2.48×10^{-11}

Device models BM4XXX-XXY-XXXXX Ryy]-S01-XX
with Y= 1, 3 or 5 (devices with a safety relay):
Size 3 - 7

- PL-d according to EN ISO 13849-1
with the following parameters:
 - Structure: cat 3
 - MTTFd: high (19026 a)
 - DC: low (60 % - 90 %)
- SIL 2 according to EN 62061 and EN 61508
with PFH = 1.7×10^{-10}

2) Two-channel connection of the shutdown via 2 safety relays:

Device models BM4XXX-XXY-XXXXX [Ryy]-S01-XX
with Y= 2, 4 or 6 (devices with two safety relays):
Size 3 - 7

- PL-e according to EN ISO 13849-1
with the following parameters:
- Structure: cat 4
 - MTTFd: high (17702 a)
 - DC: high (≥ 99 %)
- SIL 3 according to EN 62061 and EN 61508
with PFH = 1.8×10^{-12}

Additional instructions for the STO function: EN 61800 part 5.2.

For further information contact Baumüller Application department.



NOTE

The safety classifications are valid, if the following safety notes were considered and were complied with.

- The classification of the safety category applies only to the STO function.
- The following switching measures must be met to achieve the safety function:
 - Two-channel connection of the shutdown via 1 safety relay and the pulse enable circuit of the BM4000- controller LC3 for applications which require to minimize risks according to PL-d or SIL 2.
 - Two-channel connection of the shutdown via 2 safety relays for applications which require to minimize risks according to PL-e or SIL 3.
 - Control of the positively driven NC contact.
 - Using an external circuit or switching device, which is adequate for two-channel monitoring (for example safety switching device or safe control).
- The faultless functioning of the relay must be checked at least once a year. The relays must be de-energized. The closing function of the NC contacts must be monitored.
- The faultless functioning of the second path „Pulse enable“ must be checked at least once a year. The pulse enable (X3-5/3: IF+ and IF-) must be de-energized. The motor must be torque-free.
- Prior to switching on the drive for the first time (with a safety device), the state of the NC contacts must be monitored on its closing function.
- An abrupt stop of the drive or an irregular running can be caused by an error in the safety chain. The drive must be switched off, if this error occurs.
- The STO function separates the drive from its torque, but not from its voltage. For the safe isolation of the supply, other measures must be executed (for example the use of a main switch).
- A temporal excitation occurs, if the internal driver (IGBT) or a control element (also in STO state) fails. The motor can generate a magnetic field for a moment, if the DC link is „short-circuited“ via a motor winding.

If an asynchronous motor is used, then the occurring DC field cannot cause a jerk of the rotor. At a permanent-field synchronous motor the rotor rotates into a notch position. The angular movement covered, in this case depends on the rotor position and the number of pole pairs of the motor. It amounts to a maximum of $180^\circ/\text{number of pole pairs}$.
- The safety function STO may not be used at drives, where an external application of force occurs.
- A plausibility monitoring must be executed between the request signals for STO and the feedback signals by the external control.
- Installation space must be protection class of IP 54, at least.
- Cabling must be done, that no cross-circuits or short-circuits are possible.
- The incoming application must comply with the requirements of the requested minimizing risk (PL-d/SIL2 or PL-e/SIL3).

D.2.2 Function principle STO

- 1) Applications that require a minimizing risk according to performance level d (EN ISO 13849-1) or SIL 2 (EN 62061) according to chapter [▶D.2.1 Safety classifications and safety notes◀](#) from page 354 must have 2 independent shutdown paths, which are used to shut down the commutation in the power section of the inverter.

For this risk minimization the two-channel shutdown via 1 safety relay with feedback on the basic unit and the pulse enable circuit of the BM4000 controller LC3 are implemented.

The following Baumüller inverters BM4XXX-XXY-XXXXX[Ryy]-**S01**-XX in combination with the Baumüller BM4000 controller LC3 of the accordant device model have these shutdown paths:

BM4XXX-XXY-XXXXX[Ryy]-**S01**-XX with Y = 1, 3, 5:
device model with one safety relay and a discrete pulse enable circuit (size 1-7)

- 2) Applications for a minimizing risk according to performance level e (EN ISO 13849-1) or SIL 3 (EN62061) therefore need 2 independent shutdown paths, too.
The difference to **1)** is that the two-channel shutdown must be implemented via two safety relays in order to achieve a minimizing risk.

The Baumüller inverters of the b maXX of the device model BM4XXX-XXY-XXXXX[Ryy]-**S01**-XX in combination with the Baumüller BM4000 controller LC3 of the accordant device model are provided with these shutdown paths:

BM4XXX-XXY-XXXXX[Ryy]-**S01**-XX with Y= 2, 4, 6:
device model with two safety relays (size 3-7)

These device models provide an additional functional shutdown via the pulse enable circuit of the BM4000 controller LC3, besides the shutdown via both safety relays.

As the two-channel shutdown reaches performance level e and SIL3 using both safety relays, the third shutdown path will not be responded to regarding the safety requirements.

The connection diagrams [▶D.2.2.3 Connection diagrams◀](#) from page 362 and notes [▶D.2.1 Safety classifications and safety notes◀](#) from page 354 must be complied with.

D.2 Safe Torque Off (STO)

D.2.2.1 Shutdown paths

Shutdown path A Safety relay of the BM4000

The function of the safety relay is executed in fail-safe-technology, also named closed-circuit principle. The safety function is active, if no voltage is applied to the input terminals (X102-3/4; X103-3/4). At power failure the safety function is ensured. 24V must be applied to the particular terminals (X102-3/4; X103-3/4), in order to deactivate the function.

The present switching state must be responded at the positively driven feedback contact, to monitor the safety relay externally (X102-1/2; X103-1/2). The positively action contacts are closed (NC contact), if there is no voltage at the safety relay (STO is active). Also cable break is recognized as error.

If the voltage at the input terminals of the relay (X102-3/4; X103-3/4) is switched off, the inverter generates the message „Power unit warning 20: undervoltage safety relay“ or the message „Power unit error 87: error safety relay“. At an inhibited pulse enable, the warning message (warning is not saved) is generated. At pulse enable the error message (error message is saved) is generated. Commissioning or enabling the drive is possible, if there is no error in the error memory. This error memory can be reset via the digital input X1/1 of the function module DIO-01. The input X1/1 must be configured accordingly. The starting pulse length at X1/1 must last at least 5 ms.



NOTE

The starting and the shutdown sequence of the enabling signals and the safety relay must be considered, in order to assure a faultless operation of the drive. Refer to [▶Figure 115◀](#) on page 359.

Schematic diagram safety relay

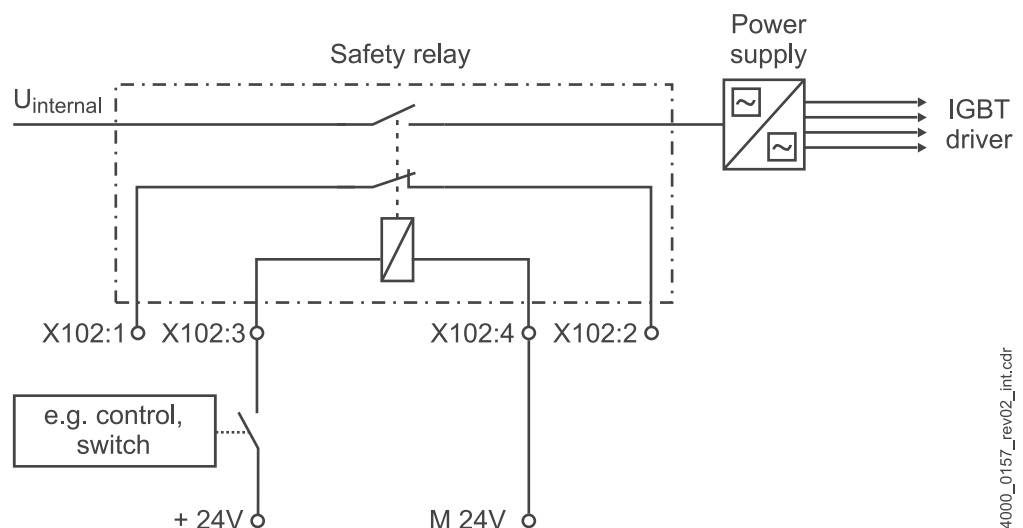

Shutdown path B

Pulse enable at BM4000 controller LC3

The safety function pulse enable is active, if no voltage is applied to the input terminals (X3-3/5). The pulses for IGBT control are inhibited.

24 V must be applied to the available terminals (X3-3/5), to deactivate the safety function.

D.2.2.2 Sequence diagram

The starting and the shutdown sequence of the release signals and of the safety relay must be considered, in order to assure a faultless operation of the drive.



NOTE

The safety function must be checked, before commissioning the machine, in which the BM4000, with the safety function STO is installed. For this purpose a protective function must be enabled (for example door contact). The motor must be with zero-torque.

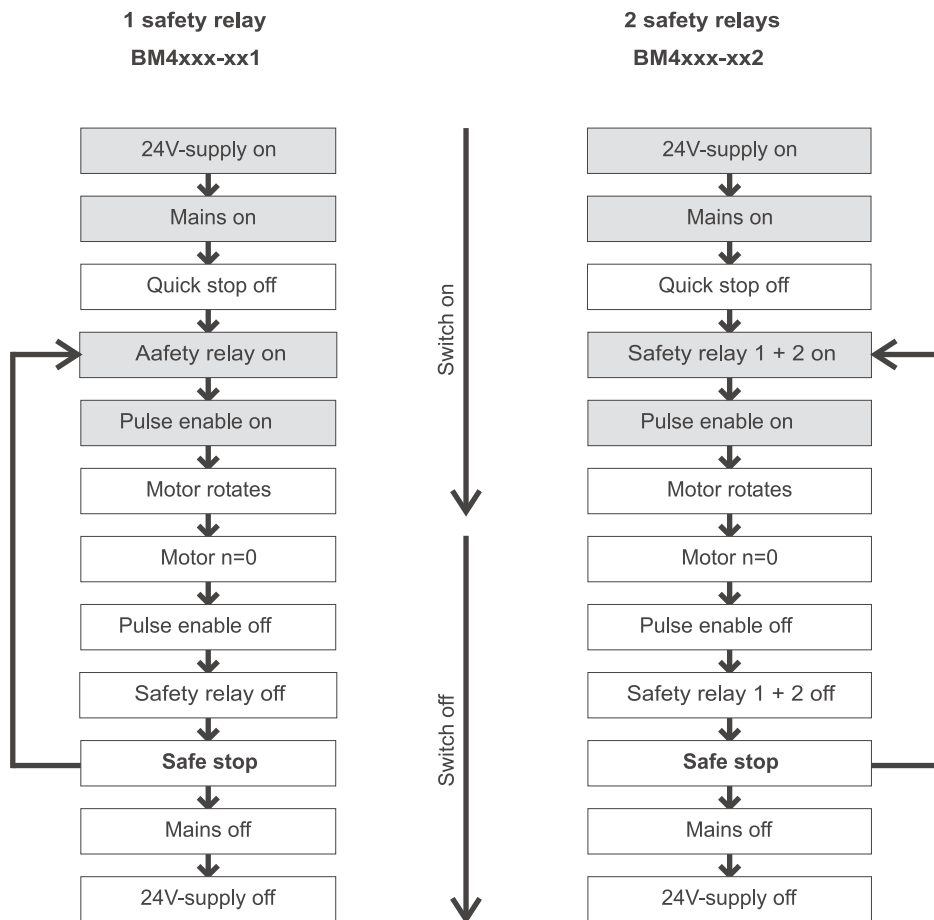

4000_0291_rev03_int.cdr

Figure 115: Sequence diagram of 1 or 2 safety relays

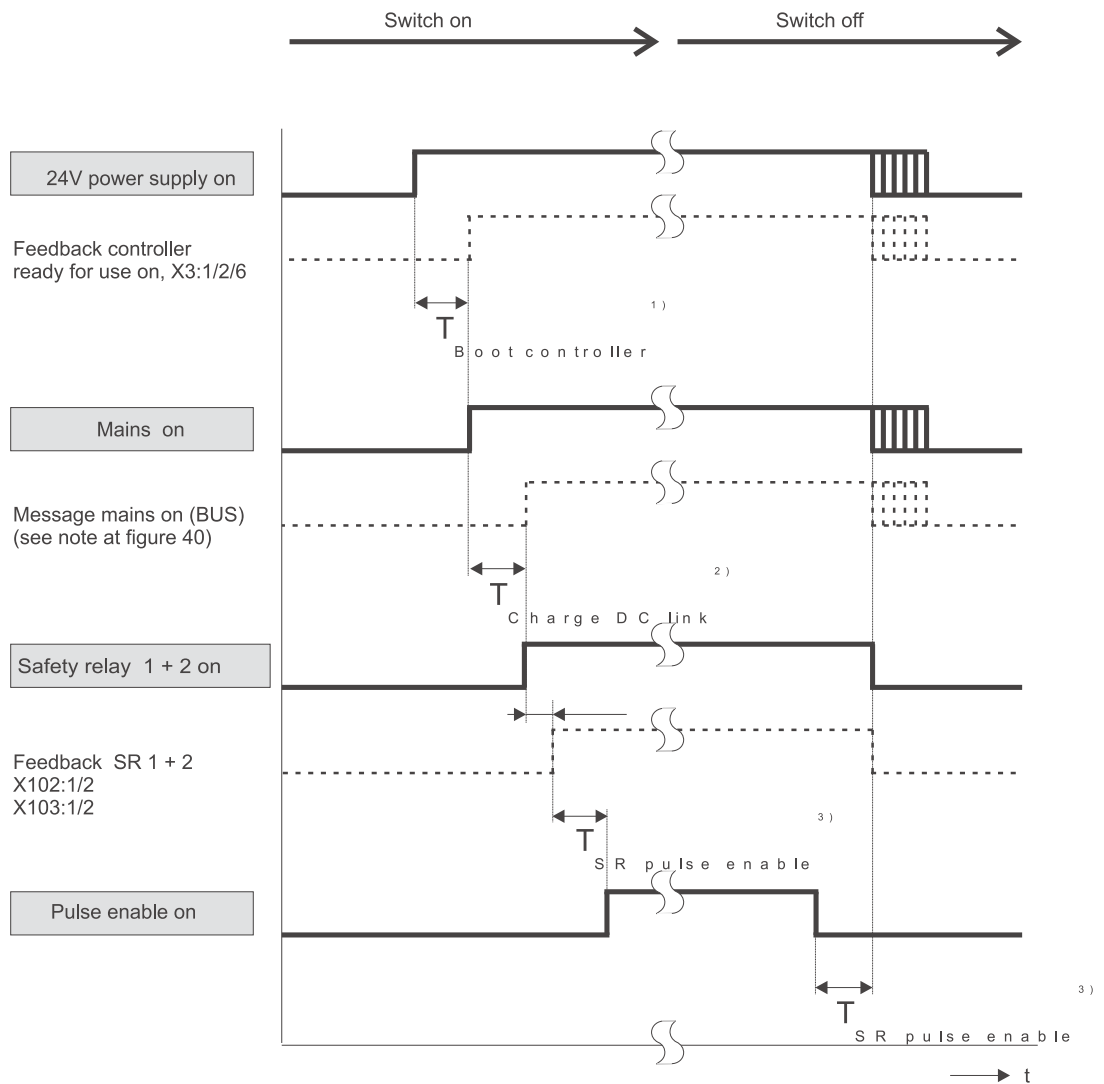

Figure 116: Timing diagram: Recommended starting / shutdown sequence.

Different starting / shutdown sequences possible. Refer to table [Different starting / shutdown options BM4X1X to BM4X7X](#) on page 361.

- 1 $T_{\text{Boot_controller}}$ dependent on the used option module (from firmware version 03.05)
approx. 5 s.
- 2 $T_{\text{Charge DC link}}$: 1.5 s (exception BM4X3X: 6 s).
- 3 $T_{\text{SR pulse enable}}$: 20 ms (exception BM4X2X: 200 ms).

Different starting / shutdown options BM4X1X to BM4X7X

Starting / shutdown condition	BM4X1X	BM4X2X	BM4X3X	BM4X4X	BM4X5X	BM4X6X	BM4X7X
Auxiliary supply (24 V) and safety relay 1 + 2 and power supply simultaneously ON	yes	yes	yes	yes	yes	yes	yes
Auxiliary supply (24 V) and safety relay 1 + 2 simultaneously ON	yes	yes	yes	yes	yes	yes	yes
Power supply „OFF“ → power supply „ON“ at pulse inhibit	yes	yes	yes	yes	yes	yes	yes
Pulse enable „ON“ at an activated safety relay	yes	yes	yes	yes	yes	yes	yes
Pulse enable and safety relay 1 + 2 simultaneously „ON“	no	no	no	no	no	no	no
Pulse enable and safety relay 1 + 2 simultaneously „OFF“	no	no	no	no	no	no	no
Safety relay 1 + 2 “ON” 20 ms before pulse enable	yes	no ¹⁾	yes	yes	yes	yes	yes
Safety relay 1 + 2 “OFF” 20 ms after pulse enable	yes	no ¹⁾	yes	yes	yes	yes	yes

¹⁾ „yes“, if $T_{SR \text{ pulse enable}} = 200 \text{ ms}$

D.2.2.3 Connection diagrams

- Device models **BM4000 with one safety relay (first safe shutdown path) and pulse enable at the controller LC3 (sizes 1 - 7) (second safe shutdown path)**

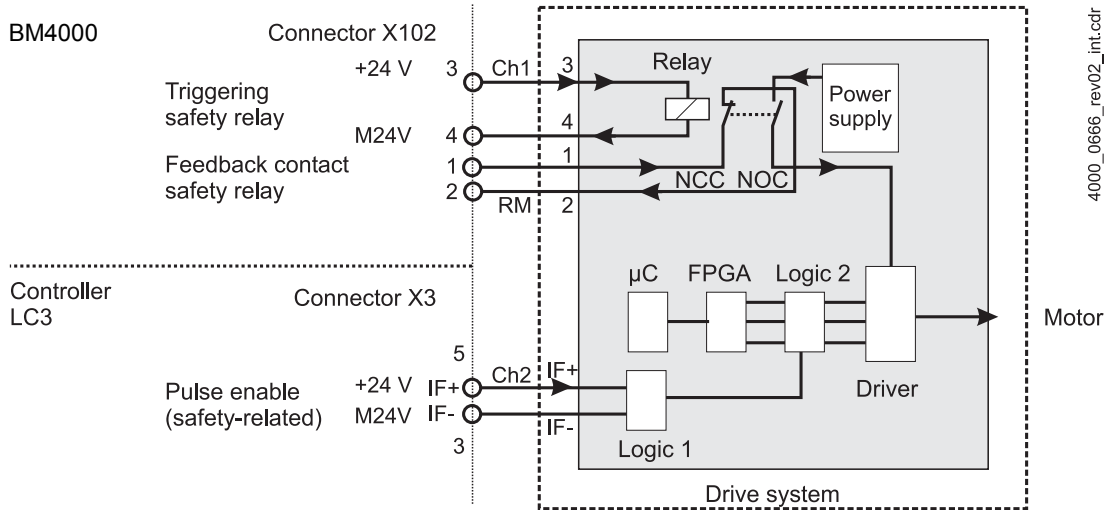

Figure 117: Shutdown paths with a safety relay and pulse enable at the controller

- Device models **BM4000 with two safety relays (safe shutdown paths) and pulse enable at the controller (functional)**

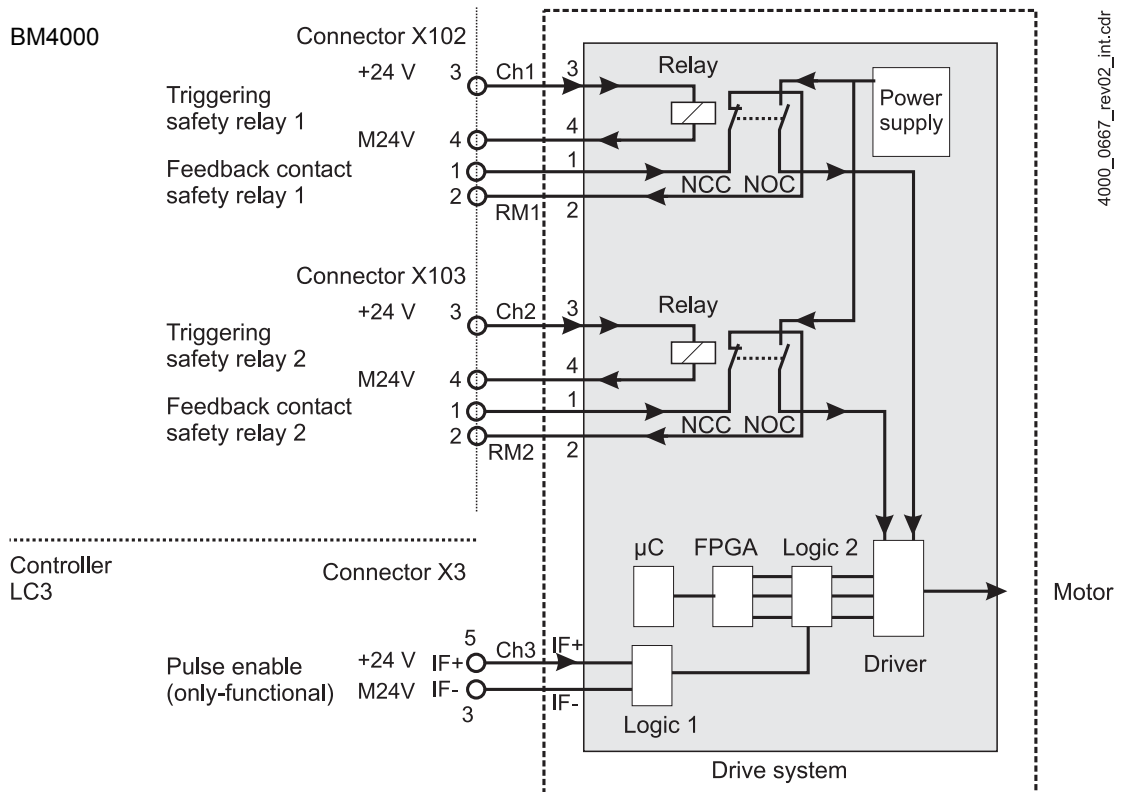

Figure 118: Shutdown paths with two safety relays

The shutdown paths on the terminals X102 and X103 of the converter BM4000 (safety relay) are implemented by positively driven relays, which interrupt the driver supply for motor control.

The drive can be moved, if the relays carry current, only (control inputs X102-3/4; X103-3/4).

The state of the relay contacts can be obtained via the positively driven NC contacts (signal outputs X102-1/2; X103-1/2)

At the device model BM4000 with a safety relay, the second shutdown path is obtained by pulse enable of the device at BM4000 controller LC3.

The safety function pulse enable is active, if no voltage is connected to the input terminals (X3-3/5). The pulses for the IGBT control is inhibited.

24 V must be connected to the terminals (X3-3/5), in order to deactivate the safety function.

D.3 Safe stop

D.3.1 Safety categories according to EN ISO 13849-1

Dependent on the possible dangers (these dangers are rated due to the consideration of the severity of the injuries, the frequency of the length of stay within the danger area and the possibilities to prevent dangers) safety-related components of machines must meet defined safety criteria. The requirements to safety-based parts are divided into five categories in the standard EN ISO 13849-1.

Category B requires basic requirements. Safety-approved components and principles in category 1, additionally. In category 2 an error between inspection intervals can lead to a loss of the safety function.

Category 3 complies with the level „the single-error-certainty to recognize errors partially“. The safety-related components may not lead to a loss of safety function, if one single error occurs. The errors are not all detected by the system, however. The accumulation of undetected errors can lead to a loss of the safety function.

Category 4 complies with level „Self-monitoring“. This component detects possible errors. These errors are reported in time. Therefore, the loss of the safety function is avoided.

The Baumüller converters of **b maXX 4000** (BM4X3X-XX2, BM4X4X-XX2, BM4X5X-XX2, BM4X6X-XX2, BM4X7X-XX2), which are operated with two safety relays (BM4XXX-XX2) optionally, comply with the requirements of **category 4** as well as with **category 3** (EN ISO 13849-1) for the safety function „Safe stop“.

The Baumüller converters of **b maXX 4000** (BM4X1X-XX1, BM4X2X-XX1, BM4X3X-XX1, BM4X4X-XX1, BM4X5X-XX1, BM4X6X-XX1, BM4X7X-XX1), which are operated with one safety relay (BM4XXX-XX1), comply with the requirements of **category 3** (EN ISO 13849-1) for the safety function „Safe stop“.

D.3.2 The safety relay

The function of the safety relay is performed in fail safe technology (closed circuit principle). The safety function „Safe stop” if no voltage is applied to the input terminals (X102-3/4; X103-3/4). The operation of the safety function is ensured at power failure. 24V must be applied to the available terminals, to deactivate „Safe stop“ (X102-3/4; X103-3/4).

The present switching state can be obtained from the positively driven feedback contacts for the external monitoring of the safety relay (X102-1/2; X103-1/2). If there is no voltage at the safety relay (X102-3/4; X103-3/4, „Safe stop“), the feedback contacts are closed (NC contact). Cable break is also detected as an error.

The converter generates „Power unit warning 20: undervoltage safety relay“ or „Power unit error 87: error safety relay“, if the voltage at the input terminals of the relay (X102-3/4; X103-3/4) is switched off. At inhibited pulse enable a warning is generated (warning is not saved) and at pulse enable an error message (errors are saved) is generated. A commissioning or enable of drive is possible, if no error is detected in error memory. Error memory can be reset via the digital input X1/1 of the function module DIO-01. Input X1:1 must be configured accordingly. The switch error storage can, for example, be reset over the digital input X1:1 of the function module DIO-01. For this the input X1/1 accordingly must be configured. The starting pulse length at X1:1 must last at least 5 ms.

D.3.3 Application example for machine of category 3

The following diagram shows the use and cabling of a Baumüller **b maXX 4000** converter in a machine tool. Complying with category 3 (EN ISO 13849-1), in this machine tool the safe removal of work pieces at an open cover, is possible.

- Application example for machine of category 3 with two shutdown channels: Pulse enable and one safety relay.

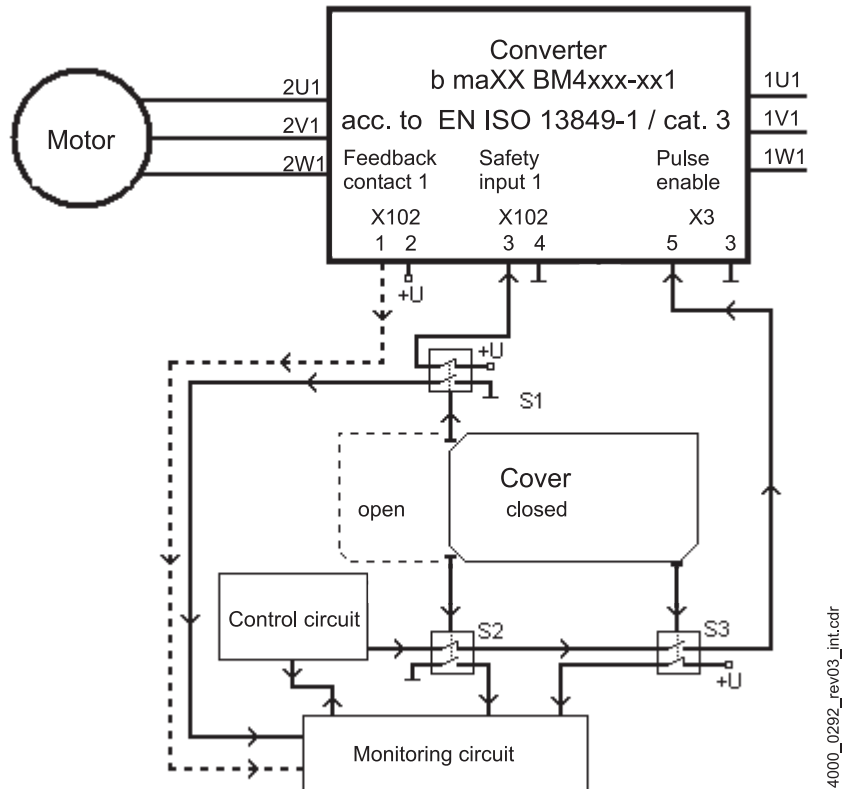

Figure 119: Version with one safety relay (BM4XXX-XX1)

The switching-off of the electrical drive motor is executed dual-ported.

- S2 (NC contact) and S3 (NO contact) have hardware effects on the pulse enable input of the converter (X3-5). Only if S2 and S3 display a closed cover (safe state), voltage is applied to the pulse enable input of the converter.
- S1 (NC contact) has hardware effects on the safety relay of the converter. Only if S1 displays a closed cover (safe state) voltage is applied at the safety relay input (X102: 3). A torque now can be generated at the motor shaft. The NO contact of S1 is connected with the monitoring circuit.
- The monitoring circuit is a fail-safe monitoring control of the category 3 (EN ISO 13849-1). It checks the directly connected switching contacts of the position switch S1 (NO contact), S2 (NO contact) and S3 (NC contact). The control circuit will not receive an enable signal from the monitoring circuit, if the cover is not completely closed or if a technically impossible state of the position switch contacts occurs (for example S1 and S2 display different switch states or if S2 and S3 show the same switch state). A missing enable signal of the monitoring device leads to a direct switching off of the converter by means of the control circuit. If the monitoring

circuit detected an error (for example different switch state of S1 and S2), this is displayed and the commissioning of the drive is not possible until the error has to the operator and a commissioning of the drive is not possible until the error is corrected.

- Additionally, the feedback contact of the safety relay (X102-1/2) can be evaluated by the monitoring circuit (not imperative).
- The position switches, which are used, must provide positively operated and mechanical contacts. The position switches must provide a dual-protected connection (a combination of NC contacts and of NO contacts). The mechanical operation at the safety device must be tamper-resistant.

The connection cables between the safety relay input (X102-3/4) and the control as well as between the pulse enable input at the converter (X3-5) and the control may not be installed in a common cable channel outside the control cabinet.

D.3.4 Application example for machine of category 4

The diagram displays the use and cabling of a Baumüller converter of **b maXX 4000** (BM4X3-XX2, BM4X4-XX2, BM4X5-XX2, BM4X6-XX2, BM4X7-XX2) in a machine tool. Complying with category 4 (EN ISO 13849-1), in this machine tool the safe removal of work pieces at an open cover, is possible.

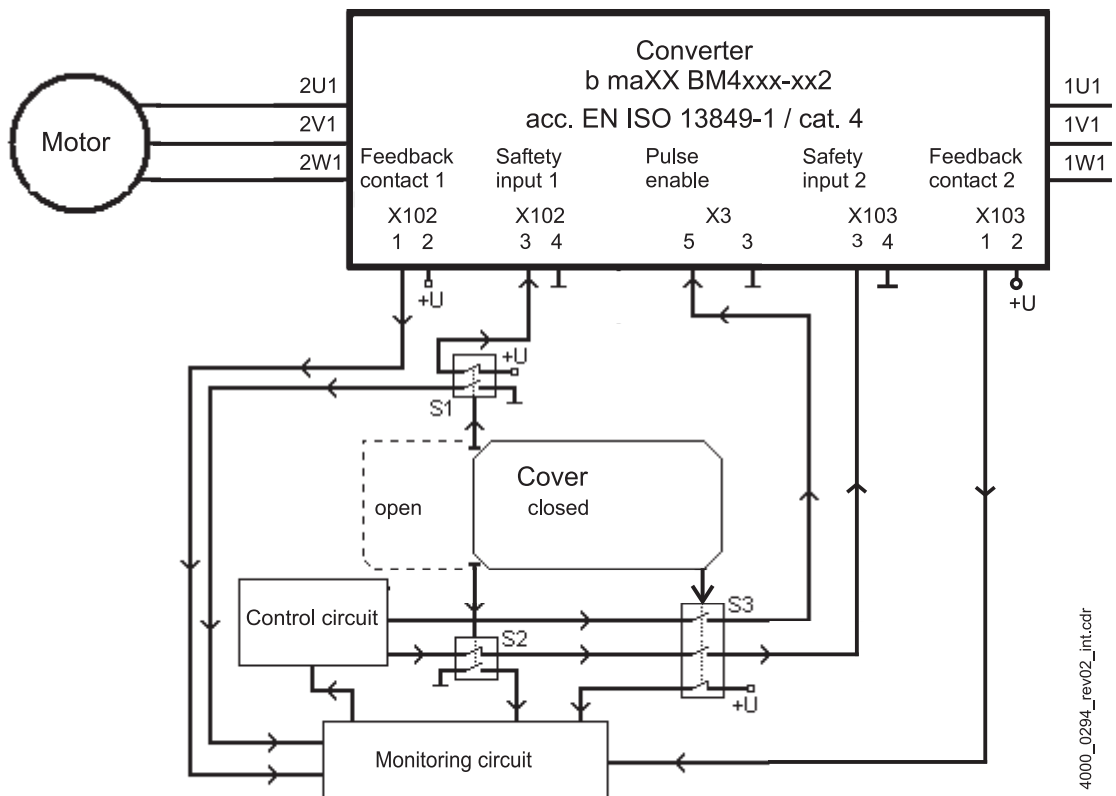

Figure 120: Version with two safety relays (BM4XXX-XX2)

The switching-off of the electrical drive motor is executed with three channels.

- S1 (NC contact) has hardware effects on the safety relay of the converter. Only if S1 displays a closed cover (safe state), voltage is applied at the safety relay input (X102-3). A torque now can be generated at the motor shaft. The NO contact of S1 is connected with the monitoring circuit.
- S2 (NC contact) and S3 (NO contact) effect the other safety relay of the converter. Only if S2 and S3 display a closed cover (safe state), voltage is applied to the safety relay input (X103-3). A torque now can be generated at the motor shaft.
- S3 (NC contact) has hardware effects on the pulse enable input of the converter (X3-5). Only if S3 displays a closed cover (safe state), voltage is applied to the pulse enable input of the converter.
- The monitoring circuit is a fail-safe monitoring control of the category 4 (EN ISO 13849-1). It checks the directly connected switching contacts of the position switch S1 (NO contact), S2 (NO contact) and S3 (NC contact) and the feedback contacts of the safety relay (X102-1/2 NO contact, X103-1/2 NO contact). The control circuit will not receive an enable signal from the monitoring circuit, if the cover is not completely closed or if a technically impossible state of the position switch contacts occurs (for example S1 and S2 display different switch states).

or if S2 and S3 show the same switch state). A missing enable signal of the monitoring device leads to a direct switching off of the converter by means of the control circuit. If the monitoring circuit detected an error (for example different switch state of S1 and S2), this is displayed and the commissioning of the drive is not possible until the error has to the operator and a commissioning of the drive is not possible until the error is corrected.

- The position switches, which are used, must provide positively operated and mechanical contacts. The position switches must provide a dual-protected connection (a combination of NC contacts and of NO contacts). The mechanical operation at the safety device must be tamper-resistant.

The connection cables between the safety relay inputs (X102-3/4; X103-3/4) as well as between the pulse enable input (X3-5) and the control circuit may not be installed in a common cable channel outside the control cabinet.

All information given in the instruction handbook of the converter, especially the chapters safety instructions, installation and commissioning, must be complied with.

For the use and the installation of the safety devices the relevant legal and official requirements of the Safety Authorities and of the EU Directives for safety-related requirements at installations and machines (for example EN 60204-1, Safety of machinery - Electrical equipment of machines - Part 1: General requirements and EN 292-2, Safety of machinery; basic concepts and general principles for design; technical principles and specifications).

D.3.5 Application expansions

The safety function „Safe stop“ is provided via three independent switch off channels and a hardware pulse enable input (category 4 according to EN ISO 13849-1) at the **b maXX 4000** converter (BM4X3X-XX2 to BM4X7X-XX2).

However, in many ranges it is not required to operate „Safe Stop“ in category 4.

In the following, application examples are viewed, at which only two of the three switch off channels are used.

- **Application example 1**

Application example for machine of category 3 with hardwired pulse enable input and process data communication via a field bus.

Switching off occurs by means of safety relay 1 and safety relay 2.

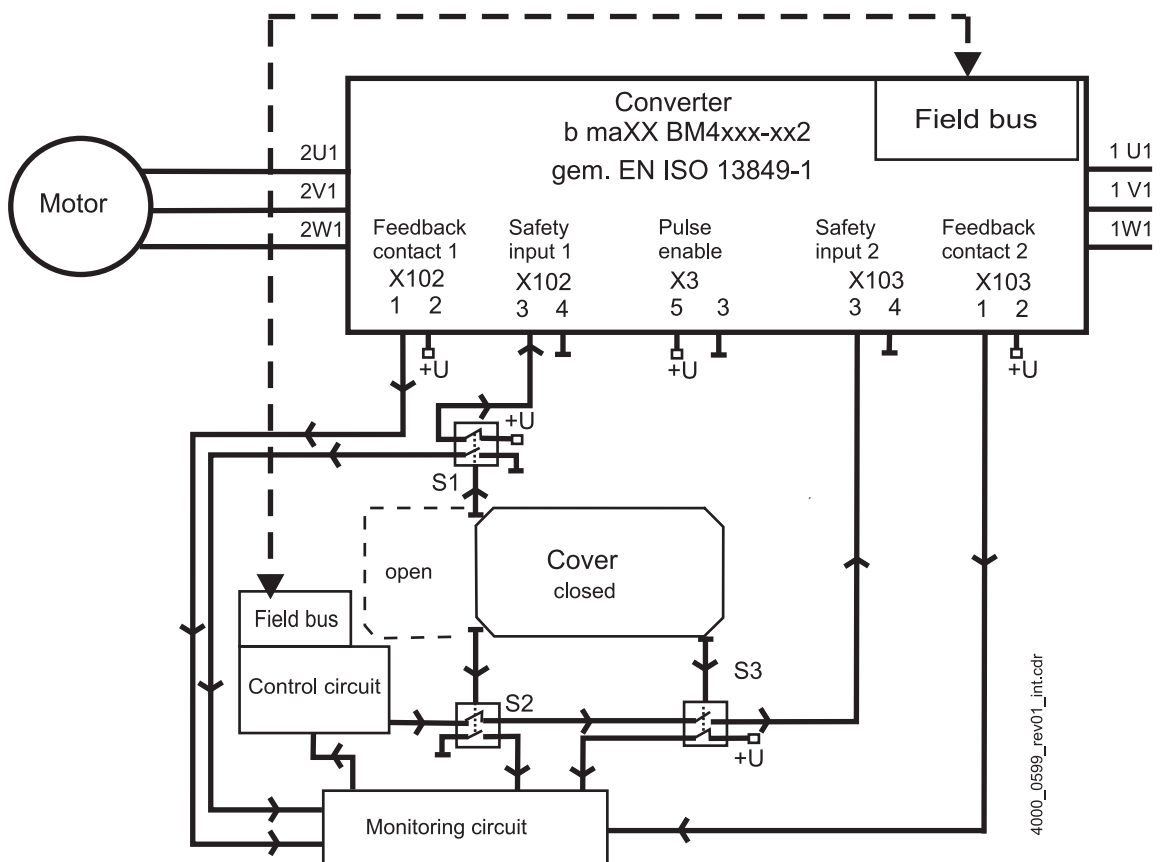

Figure 121: Version with two safety relays (BM4XXX-XX2)

Here the hardware pulse enable input (X3:5) is hardwired. The activation of the „Safe Stop“ is made with two channels via the safety relay 1 and 2 (X102:3 / X103:3).

The release of the converter and the process data communication is made via field bus.

• **Application example 2**

Application example for machine of category 3 with two switch off channels:

Pulse enable and a second common switch off channel for safety relay 1 and safety relay 2.

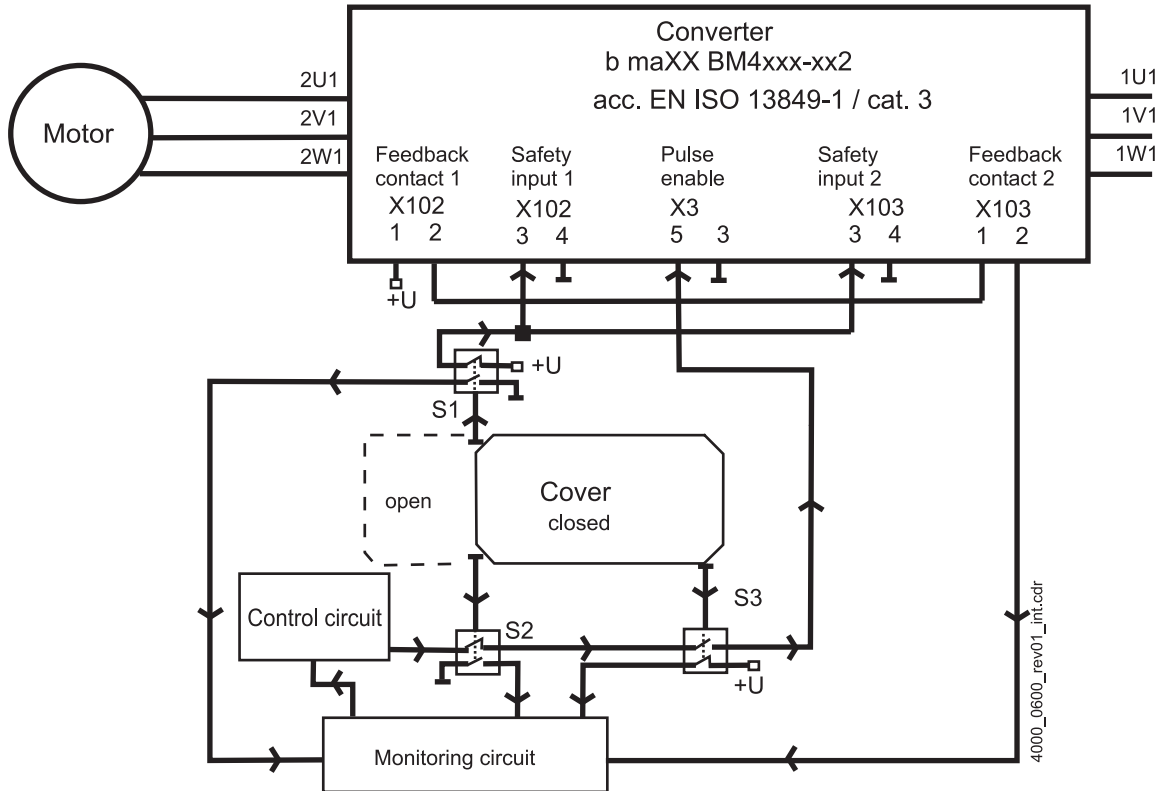

Figure 122: Version with two safety relays (BM4XXX-XX2)

Here the safety relays 1 and 2 are triggered by a position switch and together generate the first channel. The second channel is generated by the hardware pulse enable input, which is independently triggered by the safety relay.

- **Application example 3**
Pulse enable and one safety relay, only

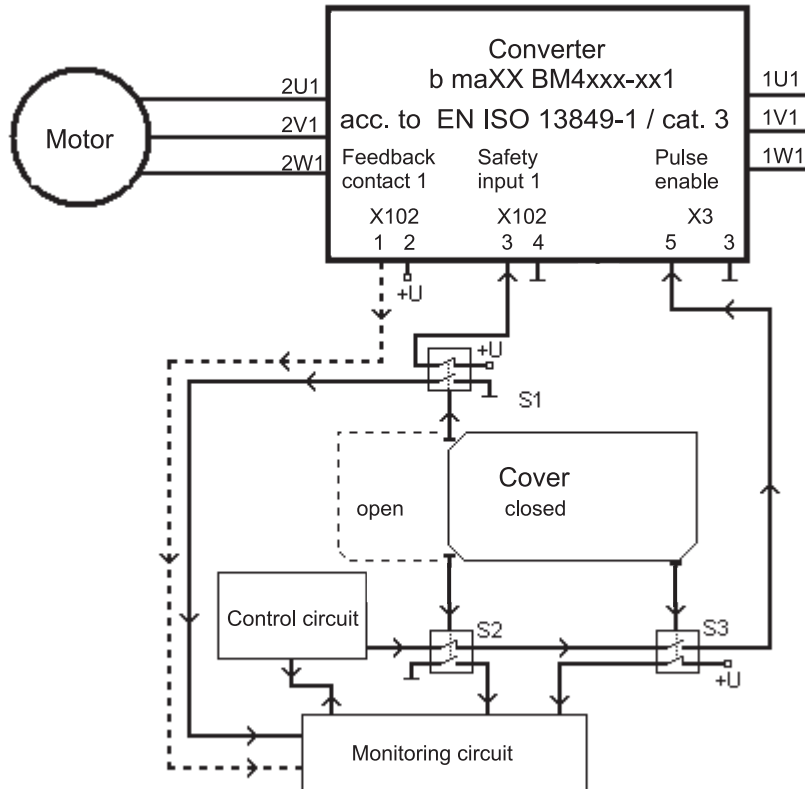

Figure 123: Version with a safety relay (BM4XXX-XX1)

This **b maXX 4000** converter is equipped with one safety relay, only. The hardware is identical with the other converters of this series - the second relay is not assembled. The internal relay switch off paths are combined and commonly generate the first channel.

The second channel generates a hardware pulse enable input, which is independently triggered by the safety relay.

D.4 Requirements on an OSSD test pulse

The test pulses detect static error conditions in the safety-related circuits. The implementation of the test pulses automatically takes place in the background. The drive functions and the safety functions are not affected.

The pulse enable inputs (X3-5) and the safety relays (X102-3/4, X103-3/4) of **b maXX 4000** are provided for the use of an OSSD test pulse.

The test pulses have the following limit values:

	Value	Description
t_{TPLmax}	3 ms	Maximum low time of the test pulse
t_{TPmin}	100 ms	Minimum period of the test pulse

OSSD test pulse

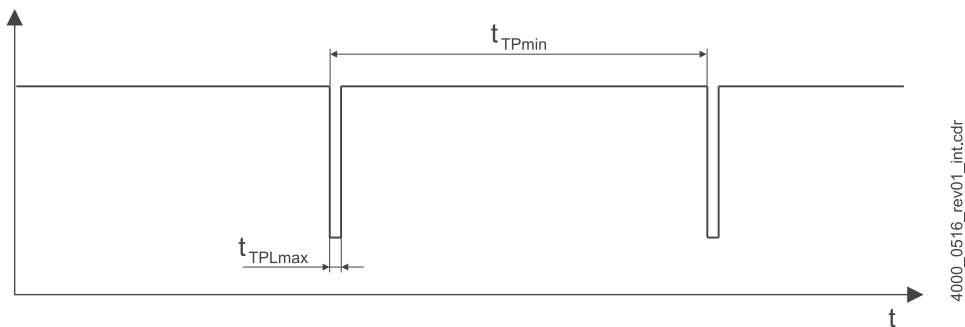

Figure 124: OSSD test pulse

Thresholds for the inputs X3-5 and X102-3/4, X103-3/4:

Input	Threshold
X3-5 (pulse enable)	Low level: 0 V to 5 V High level: 12 V to 28 V
X102-3/4, X103-3/4 (safety relay)	High level: 20 V to 28 V (24 V -15 % / +20 %)

D.5 Technical data safety relay module



DANGER!

Risk of injury by moving parts!

Mechanical effects due to the failure of the safety relay.

Therefore:

The minimum load of the contacts X102-1 and X102-2 (accordingly X103-1 and X103-2) may not fall below the specified values. Operate the safety relay within the specification.



NOTE

A device with safety relay is not a safe device. The device with safety relay does not comply with the PL level according to ISO 13849 and SIL according to EN 61800, if the part number **does not** start with „06“.

This device is not certified for safety functions!



NOTE

Devices with the approval mark of TÜV Rheinland and the Safety label provide a certified safety function, only, refer to [►Page 31◀](#).



Single safety relay:

	BM4XXX-XX1-XXXXX-S01 Single safety relay module with high power current contacts	BM4XXX-XX3-XXXXX-S01 Single safety relay module with low power current contacts ¹⁾	BM4XXX-XX5-XXXXX-S01 Single safety relay module Elestra
Coil side, Triggering of one safety relay (X102-3, X102-4)			
Rated voltage U_{DC}	24 V	24 V	24 V
Operating voltage range	-15% / +20%	-15 % / +20 %	-15% / +20%
Control current I_{DC}	Max. 70 mA	Max. 70 mA	Max. 35 mA
Feedback contact, 1 x NC contact (X102-1, X102-2)			
Switching voltage U_{DC}	24 V	24 V	24 V
Switching current I_{DC}	10 mA to 4 A ²⁾	10 mA to 300 mA ²⁾	10 mA to 4 A ²⁾
Switch-on frequency	Max. 6/min	Max. 10/s	Max. 12/s
Activation delay time at rated voltage U_{DC}	Max. 25 ms	Max. 15 ms	Max. 15 ms
Deactivation delay time	Max. 15 ms	Max. 12 ms	Max. 12 ms
Electrical endurance	At least 10^5 operating cycles	At least 10^5 operating cycles	At least 10^5 operating cycles
Mechanical service life	At least 1×10^7 switching cycles	At least 5×10^7 switching cycles	At least 1×10^7 switching cycles

- 1) Customer-specific versions, only.
Contact Baumüller Nürnberg GmbH before using this version.
- 2) A switching current of at least 20 mA is recommended. If the load is below 20 mA the switching current must be increased by a base load (refer to [►Figure 125](#) on page 376).

Double safety relay:

	BM4XXX-XX2-XXXXX-S01 Double safety relay module with high power current contacts	BM4XXX-XX4-XXXXX-S01 Double safety relay module with low power current contacts ¹⁾	BM4XXX-XX6-XXXXX-S01 Double safety relay module Elestra
Coil side, input signal of two safety relays (X102-3, X102-4) (X103-3, X103-4)			
Rated voltage U_{DC}	24 V	24 V	24 V
Operating voltage range	-15% / +20%	-15 % / +20 %	-15% / +20%
Control current I_{DC}	Max. 70 mA	Max. 70 mA	Max. 35 mA
Feedback contact, 1 x NC contact (X102-1, X102-2) (X103-1, X103-2)			
Switching voltage U_{DC}	24 V	24 V	24 V
Switching current I_{DC}	10 mA to 4 A ²⁾	10 mA to 300 mA ²⁾	10 mA to 4 A ²⁾
Switch-on frequency	Max. 6/min	Max. 10/s	Max. 12/s
Activation delay time at rated voltage U_{DC}	Max. 25 ms	Max. 15 ms	Max. 15 ms
Deactivation delay time	Max. 15 ms	Max. 12 ms	Max. 12 ms
Electrical endurance	At least 10^5 operating cycles	At least 10^5 operating cycles	At least 10^5 operating cycles
Mechanical service life	At least 1×10^7 switching cycles	At least 5×10^7 switching cycles	At least 1×10^7 switching cycles

- 1) Customer-specific versions, only.
Contact Baumüller Nürnberg GmbH before using this version.
- 2) A switching current of at least 20 mA is recommended. If the load is below 20 mA the switching current must be increased by a base load (refer to [►Figure 125](#) on page 376).

- Installation of the feedback contact with a permanent load

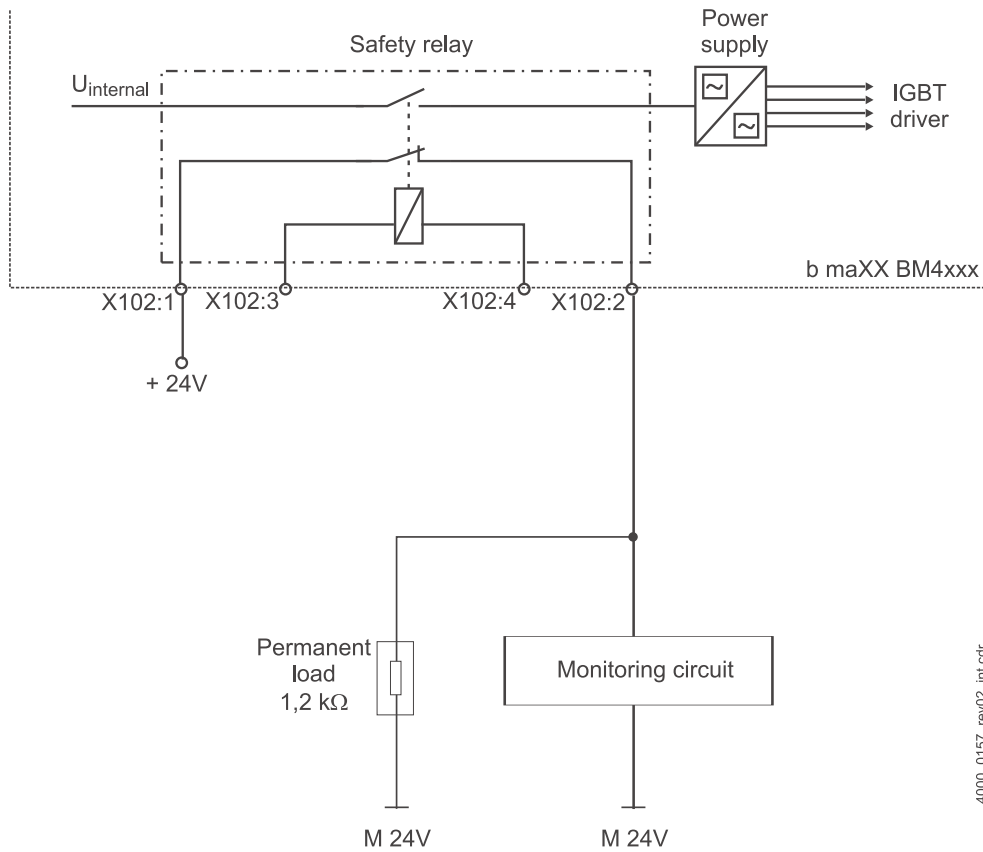

Figure 125: Installation of the feedback contact with permanent load

Continuous load e.g.:

Housing:	Phoenix Contact, EMG12-B2 Part No.: 2948306
Transparent cover:	Phoenix Contact, BMG12-H 7.5 mm Part No.: 2947116
Resistor:	1.2 kΩ / 1 W at $T_U = 70\text{ °C}$



Table of Figures

Wiring of the power cables.....	18
Signs and labels BM4X1X.....	27
Signs and labels BM4X3X/BM4X4X	28
Signs and labels BM4X5X.....	29
Signs and labels BM4X6X, BM4X7X	30
Type code labeling	31
Dimensions BM441X.....	34
Dimensions BM442X-S/A.....	35
Dimensions BM442X-F/C.....	36
Dimensions BM443X-S/Z, BM443X-A/F	37
Dimensions BM443X-C, BM463X-F.....	38
Dimensions BM444X-S/Z, BM464X-S/Z	39
Dimensions BM444X-A/F, BM464X-A/F	40
Dimensions BM445X-S/Z, BM465X-S/Z	41
Dimensions BM445X-A/F, BM465X-A/F	42
Dimensions BM465X-FXX-3XXXX and BM475X-FXX-3XXXX	43
Dimensions BM465X-FXX-3XXXX-RYY, BM475X-FXX-3XXXX-RYY	44
Dimensions BM465X-ZXX-3XXXX-[RYY], BM475X-ZXX-3XXXX-[RYY].....	45
Dimensions BM446X-S/Z.....	46
Dimensions BM446X-A/F and BM466X-A/F	47
Dimensions BM466X-FXX-3XXXX and BM476X-FXX-3XXXX	48
Dimensions BM466X-Z-3XXXX and BM476X-Z-3XXXX	49
Dimensions BM447X-F, BM477X-F	50
Dimensions BM447X-A.....	51
Reducing of the output power in dependence of the absolute altitude	58
Output current in dependence of the input voltage	59
Reducing the output voltage in dependence with the input voltage	60
Reducing the output power in dependence of the system voltage.....	60
Calculation of the thermal RMS current	61
Coherence between peak current and rated current.....	61
Cooling air requirement.....	63
Derating of output current BM441X universal units.....	66
Maximum external DC link capacitance BM441X	67
Derating the output current BM442X universal units.....	70
Maximum external DC link capacitance BM442X	71
Derating the output current BM443X universal units.....	73
Derating the output current BM444X universal units.....	76
Reducing of output current BM445X universal units	79
Reducing of output current BM 446X universal units	82
Derating the output current BM 447X universal units.....	85
Derating the output current BM4632 acceleration units	88
Derating the output current BM464X acceleration units.....	90
Derating the output current BM465X acceleration units.....	92
Derating the output current BM466X acceleration units.....	94
Derating the output current BM47XX continuous current units	96
Derating the output current BM442X power modules	99
Derating the output current BM443X power modules	101
Derating the output current BM444X power modules	103
Derating the output current BM445X power modules	105
Derating the output current BM446X power modules	107
Derating the output current BM446X power modules	109
Conversion brake power time area in triangular time area	111
Braking cycle.....	112
Continuous current derating at a statical output frequency < 15 Hz	116
Reduction BM46XX max. current and PWM frequency at output frequencies < 10 Hz	117
Reduction BM46XX only max. current at output frequencies < 10 Hz	117
Position of type plate.....	129
EtherCAT® Address switch setting	142
CANopen® address switch.....	144
Danger area near the mechanical mounting.....	149
Drilling pattern BM441X	151



Table of Figures

Drilling pattern BM442X	152
Drilling pattern BM443X, BM463X	152
Drilling pattern BM444X, BM464X	153
Drilling pattern BM445X, BM465X	154
Drilling pattern BM465X-FXX-3XXXX, BM475X-FXX-3XXXX	154
Drilling pattern BM446X, BM466X	155
Drilling pattern BM466X-FXX-3XXXX, BM4766-FXX-3XXXX	156
Drilling pattern BM447X-F, BM477X-F	157
Drilling pattern BM447X-A	158
Mounting instruction BM441X, BM442X-S, BM4X3X-S/Z, BM444X-S/Z, BM464X-S/Z	160
Mounting instruction BM445X-S/Z, BM465X-S/Z, BM446X-S/Z, BM466X-S/Z	161
Mounting instruction BM447X-A/F, BM477X-FXX-3XXXX	162
Mounting instruction „diverse“	163
Control cabinet mounting BM442X-A/F	165
Single phase connection BM441X	171
Single phase connection (BM442X ... BM447X, basic units)	171
Connection to single phase grounded power supply systems with an isolated transformer	172
Mounting - single ring core	176
Mounting - several ring cores	176
Connection diagram with a directly controlled motor brake - basic units	180
Connection diagram with motor brake controlled via an add. relay - basic units	182
Connection diagram with a directly controlled motor brake - power modules	183
Connection diagram with motor brake controlled via an additional relay - power modules	185
Connection fan	186
Electrical connections for power supply, motor, ... for BM4412 and BM4413	188
Electrical connections for power supply, motor, ... for BM4414	189
Electrical connections for power supply, motor, ... for BM442X	190
Electrical connections for power supply, motor, ... for BM443X, BM463X	191
Electrical connections for power supply, motor, ... for BM444X, BM464X	192
Electrical connections for power supply, motor, ... for BM445X, BM465X, BM446X, BM466X	193
Electrical connections for power supply, motor, ... for BM466X and BM476X	194
Electrical connections for power supply, motor, ... for BM4755	195
Electrical connections for power supply, motor, ... for BM447X and BM4773	196
Connection X100 and terminals of a standard controller	203
Connection cable BM4-F-ENC-07	218
Connection cable BM4-F-ENC-17	220
Connection cable BM4-F-ENC-27	222
Connection cable BM4-F-ENC-08	224
Skinning length	227
Error messages 7-segment display	240
ProDrive version conflict	241
ProDrive start screen	242
Project navigation in ProDrive	242
Drive manager ProDrive	243
ProDrive Drive manager	245
Survey error list	246
Hazard areas during electrical installation	267
Interface cable RS 232	278
Mains filter type code	300
Type code power choke	307
Figure power choke	308
Cable connectors, 12-wire	315
Cable connector for sine-cosine encoder with EnDat [®] -interface	317
Sequence diagram of 1 or 2 safety relays	359
Timing diagram: Recommended starting / shutdown sequence	360
Shutdown paths with a safety relay and pulse enable at the controller	362
Shutdown paths with two safety relays	362
Version with one safety relay (BM4XXX-XX1)	366
Version with two safety relays (BM4XXX-XX2)	368
Version with two safety relays (BM4XXX-XX2)	370
Version with two safety relays (BM4XXX-XX2)	371
Version with a safety relay (BM4XXX-XX1)	372
OSSD test pulse	373
Installation of the feedback contact with permanent load	376



Overview of Revisions

Version	Status	Changes
5.12008.01	22-May-2013	First issue
5.12008.02	09-Sep-2013	Chapter encoder, encoder cables added New version declaration of Conformity according Machinery Directive
5.12008.03	10-Jan-2014	Chapter Troubleshooting and fault correction adapted Correction Technical data
5.12008.04	01-Dec-2014	Error correction
5.12008.05	20-Jul-2015	Calculation for water-cooled brake resistors
5.12008.06	24-Sep-2015	New choke types, new device type
5.12008.07	7-Jul-2016	Revision Technical data
5.12008.08	26-Apr-2017	Revision
5.12008.09	1-Mar-2018	Chapter: Avoid current bearings added
5.12008.10	5-Nov-2018	Revision
5.12008.11	10-Dec-2018	Revision chapter Safe Stop
5.12008.12	22-May-2019	Risk assessment added BM4472, BM4473 power module added
5.12008.13	28-Nov-2019	Revision
5.12008.14	07-Jul-2021	Revision

be in motion

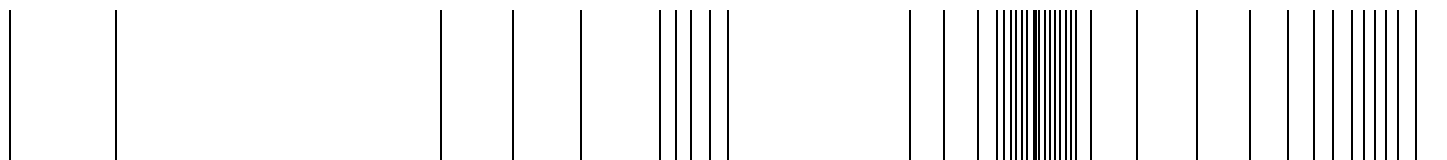

Baumüller Nürnberg GmbH Ostendstraße 80-90 90482 Nürnberg T: +49(0)911-5432-0 F: +49(0)911-5432-130 www.baumueller.com

All information given in this manual is customer information, subject to change without notice. We reserve the right to further develop and actualize our products continuously using our permanent revision service. Please notice, that specifications/data/information are current values according to the printing date. These statements are not legally binding according to the measurement, computation and calculations. Before you make any information given in this manual to the basis of your own calculations and/or applications, please make sure that you have the latest edition of the information in hand. No liability can be accepted concerning the correctness of the information.