



Pneumatic Catalogue

Quick Coupling Systems for Pneumatic and Fluid Handling



ENGINEERING YOUR SUCCESS.

THE RIGHT SOLUTION FOR EVERY SECTOR.



Whether under water, in aerospace, on the high seas, on the street, or in industry – our quick connect coupling systems are at home in many domains and represent the right solution in numerous technical applications.

The modular structure of our series allows you to benefit from a wide standard range, which includes a suitable system for most applications – just-in-time goes without saying.



Structure of Part Numbers

Hose Connection

TF = Hose Barb
 TH = Hose Barb 45°
 TR = Hose Barb 90°
 TZ = Straight shaft parallel
 TP = Parker Push-Lok
 PH = Parker Push-Lok 45°
 PR = Parker Push-Lok 90°
 TS = Panel Mount with Hose Barb
 TD = Hose Barb DIN EN 560
 TE = Front Panel Installation, Hose Barb Panel Mount

Plastic Tube Connection

KO = with Hose Nut, without spring guard
 KR = 90° KO - connection
 KS = Panel mounted, without spring guard
 KK = with spring guard
 KE = Front panel installation with KO - connection
 KP = Plastic tube connection
 (hard plastic hoses, only for RECTUCHEM)

Other Connections

KL = Insert for plug-in connection
 PV = Fixing connection for PVC hoses
 DS = Double plug-in nipple

Male Thread

AW = Whitworth pipe thread ISO 228 parallel
 AM = Metric thread DIN 13
 AK = Whitworth pipe thread DIN 2999 tapered
 AN = NPT thread ANSI B 1.20.1 tapered
 AD = Metric thread DIN 2353 (ISO 8434-1)
 WP = Whitworth pipe thread ISO 228 Serto Plan
 MP = Metric thread DIN 13 Serto Plan
 SW = Panel mount Whitworth pipe thread
 ISO 228 Serto Plan
 SM = Panel mount metric thread DIN 13 Serto Plan
 AL = Whitworth pipe thread ISO 228 parallel left
 AR = 90° Whitworth pipe thread DIN 2999 tapered
 AE = Front Panel Installation with Whitworth pipe
 thread ISO 228 parallel
 AJ = UNF thread (JIC) with 37° cone by SAE J 514

Female Thread

IW = Whitworth pipe thread ISO 228 parallel
 IM = Metric thread DIN 13
 IK = Whitworth pipe thread ISO 7 corresponding
 DIN 2999 tapered
 IN = NPSF-thread ANSI B 1.20.3
 IT = NPT thread tapered ANSI B 1.20.1
 IF = UNF-thread
 IL = Whitworth pipe thread ISO 228
 parallel left

Adding 1

S = Marking for special version
 0 = RECTUKey round
 3 = RECTUKey triangle
 6 = RECTUKey hexagon
 8 = RECTUKey octagon

21 KA AW 13 M P X X X

Series No:

Couplings

KA = Single Shut-Off
 KB = Double Shut-Off
 KF = Straight-Through
 KL = Dry-Break (double shut-off)
 KE = Self-Venting System
 KS = Safety (single shut-off)
 KD = Safety (double shut-off)
 KR = Safety (straight through)

Plugs

SF = Straight-Through
 SB = Double Shut-Off
 SL = Dry-Break (double shut-off)
 SS = Safety (straight-through)
 SD = Safety (double shut-off)
 SR = Recoil Eliminator

Metric Thread

05 = M5
 10 = M10 x 1
 12 = M12 x 1,5
 14 = M14 x 1,5
 16 = M16 x 1,5
 18 = M18 x 1,5

Thread Sizes

10 = 1/8"
 13 = 1/4"
 17 = 3/8"
 21 = 1/2"
 26 = 3/4"
 33 = 1"
 38 = 1 1/8"
 42 = 1 1/4"
 48 = 1 1/2"
 54 = 1 3/4"
 60 = 2"

Hose Connection

03 = for 3 mm LW (1/8")
 04 = for 4 mm LW (3/16")
 06 = for 5 mm LW (1/4")
 08 = for 8 mm LW (5/16")
 09 = for 9 mm LW (3/8")
 13 = for 13 mm LW (1/2")
 19 = for 19 mm LW (3/4")
 25 = for 25 mm LW (1")

Plastic Hose

04 = for 3 x 4 mm
 05 = for 3 x 5 mm
 36 = for 3 x 6,3 mm
 06 = for 4 x 6 mm
 46 = for 4 x 6,3 mm
 08 = for 6 x 8 mm
 10 = for 8 x 10 mm
 12 = for 9 x 12 mm
 16 = for 13 x 16 mm

Material

M = Brass CuZn39Pb3
 2.0401 (except sleeve)
 B = Brass CuZn39Pb3
 2.0401 (completely)
 S = Steel 9SMnPb28K
 1.0718
 R = Stainless Steel
 AISI 303
 H = Stainless Steel
 AISI 316 LMO
 E = Stainless Steel
 AISI 316 L
 D = POM (Delrin)
 F = PVDF

Surface

X = without surface treatment
 N = Nickel plated
 C = Chrome plated
 Z = Zinc plated
 D = Durnicoated (chemic. zinc plated)
 B = Browning (steel black)
 G = Zinc plated and yellow chromated
 P = Passivated
 P = Pressure springs made of PEEK
 (only for RECTUCHEM+)
 F = chemically nickel plated and
 chrome plated (Flashchrome)
 S = zinc plated and black chromated

Seal

X = without seal
 P = Perbunan NBR
 V = FKM/FPM
 E = Ethylene-Propylene
 EPDM
 S = Silicone
 K = FFKM

Adding 2 Color coding for plastic

B = Blue
 G = Green
 R = Red
 Y = Yellow

Key to Symbols in Application Area



Machinery Construction



Electrical Engineering



Medical Technology



Mobile Hydraulics



Food Technology



Aeronautics



Safety Technology



Trade



Chemical Technology



Automotive

Important Notes:

- Please note that the technical data, specifications and drawings in the catalogue are not binding. This information is subject to change without notice in the interest of improvement.
- We reserve the right to make technical modifications for the purposes of improvement.
- May 2017: With the actual catalogue the older versions are no longer valid.
- The interchangeability is guaranteed under the assumption that the manufacturer of the relevant product has not changed any functional part in the meantime.
- You will find important safety instructions on pages 12 and 13.

Structure of the Pneumatic Catalogue

		DN	Series	KF	KA	KB	KL			DN	Series	KF	KA	KB	KL		
Brass / Steel		1,5	Series 02		15			Thermoplastic	Standard	3	Series PPM	173	173	173			
		2,5	Series 50		17					5	Series 21		177	177			
		2,7	Series 20		19	21				6	Series PPL	183	183	183			
		5	Series 17		25					7	Series 48		187	187			
		5	Series 21		27	31	35			4,3-30	Series 70 Components			191			
		5,5	Series 1100		39	40											
		5,5	Series 14		43				Flat sealing	Standard	3-12	Series NSI				195	
		5,5	Series 18		45						3-19	Series 200KLEK					197
		5,5	Series 19		47						4-9	Series 200KL					199
		5,5	Series 22		49						6	Series RNS					203
		5,5	Series 1400		51						6-12	Series NSP					205
		5,5	Series 24		53						10-12	Series NSA					207
		6	Series 52		55	55			19	Series NSE					209		
		7,2	Series 26		59	62											
		7,4	Series 1300		65	66			Safety	Standard	5	Series 21	211	212			
		7,5	Series 13		69						7,8	Series 25		215	216		
		7,8	Series 25		71	73				Breathing Air	7,4	Series 95		219			
		7,8	Series 1600		77						7,4	Series 96		221			
		7,8	Series 1625		79					Self-Venting	5,5	Series 14		223			
		8	Series 33		81						5,5	Series 1400		225			
		8,5	Series 30		83				5,5		Series 24		227				
		9	Series 40		85				7,4		Series 26		229				
		10	Series 27		87	88			7,8	Series 1600		231					
		10	Series 1700		91				10	Series 1700		233					
		10	Series 1727		93				Coded Systemes	5	Series 21		235				
	10	Series 1800		95	96		7,8	Series 25			237						
	10	Series 34		101			Accessories	Components									
	10	Series 41		103				Blow Guns									
	11	Series 42		105													
	11	Series 37		107			Hoses & Tubing	Rectulastic									
	12	Series 57		109	109			Rectuflex									
	12,4	Series 1900		113	113			Superbraid									
	13	Series 29		117				Ultra-Lite									
	15	Series 38		119	119			Rectusoft									
	19	Series 39		123	123	124		Accessories									
	4,3-20	Series 70			127												
	22	Series 2100		129													
Stainless Steel		2,7	Series 20		133	135											
		3	Series 303			139											
		5	Series 21		141	142	144										
		7,4	Series 1300		147	147											
		7,4	Series 25		151	152	154										
		10	Series 27		157	158											
		10	Series 1800		161	162											
	4,3-20	Series 70			165												

ARE YOU HOPING TO FIND WITHOUT LOOKING? THEN WE HAVE JUST THE THING FOR YOU.

Brass/Steel

Here, you will find a broad range of standard coupling systems in brass and/or steel with various valve types (single, double, flat sealing) for compressed air and

water as well as applications with liquid and gaseous media.

Page 14 – 131

Stainless Steel

The coupling systems in this chapter have been designed in V2A (AISI 303) or V4A stainless steel (AISI 316 L) specifically for liquid and/or aggressive media and

impress with their high corrosion resistance and great strength.

Page 132-165

Thermoplastic

Various materials in POM and PVDF and a broad range of coupling systems allow a wide spectrum of

possible applications, e.g. in medical technology and in the pharmaceutical sector.

Page 166-193

Flat sealing

Our flat sealing coupling systems stand out for their extremely low leakage rates and minimal dead space volume. With them no air is trapped during the

coupling process and only a barely noticeable film of the medium being carried remains on the valve bodies when uncoupling.

Page 194-209

Safety

Systems with safety locking protect against unintentional uncoupling. Venting systems reliably prevent the whiplash effect and thus improve safety in the

workplace. Special couplings for respiratory protection applications are optimised for use even in extreme situations.

Page 210-233

Coded Systems

These systems are the right choice wherever there is a risk of mixing up different circuits. Depending on the design with mechanical and/or color coding, they

reliably impede or prevent incorrect coupling.

Page 234-237

Accessories

A broad range of brass, stainless steel and aluminium fittings as well as plastic and aluminium blow guns

is the ideal addition to our comprehensive couplings range.

Page 238-257

Hoses and Tubing

Here, you will find a large selection of hoses in various materials (nylon 12, polyurethane, PVC) and shapes (straight, spiral) with or without fabric lining and bondi-

ng as well as reusable hoses to round off the mix.

Page 258-275

COUPLING QUICKLY AND SAFELY WITH ONE HAND.



The development of the single-hand quick connect coupling made a decisive contribution to improving work safety and functionality. In order to create a connection, the plug is simply pushed into the coupling. This causes the sleeve to spring forward and lock

automatically. When uncoupling, the sleeve is pushed back with one hand and the connection is disengaged with no problem whatsoever. The following four valve designs are available for selection for different applications:

Straight-Through

These coupling systems work with no shut-off valve and therefore achieve the greatest possible flow. Furthermore, turbulence which can occur with integrated valves is completely

eradicatd. Straight-through couplings are ideally suited to liquid media – e.g. water applications. Before unlocking, the flow must be stopped.

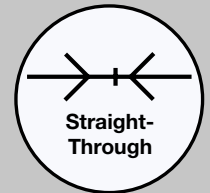

Single Shut-Off

On our single shut-off systems, the plug is designed straight-through – although the coupling shuts off immediately when the connection is broken.

Appearance of on-flow media in the line is effectively prevented. An ideal solution for operating compressed air tools.

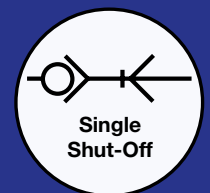

Double Shut-Off

On our double shut-off systems, after disconnection, the flow stops both in the coupling and in the plug.

The medium remains in the hose in both connecting lines, the pressure is held constant and not released.

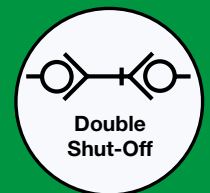

Flat sealing design

On the coupling and plug, our flat sealing coupling systems have valves that build up no dead-space volume. As such, when the connection is broken, no drops of the medi-

um being channelled are able to escape. This variant is especially suitable for transporting aggressive media or in sensitive environments – e.g. in cleanrooms.



THE DIFFERENCE LIES IN THE VALVE.

The valve design is the linchpin of any coupling system and it is essentially responsible for the flow / pressure loss on a coupling. Depending on the medium and application,

the use of a system with optimised valve technology can save a great deal of energy, e.g. in the supply to compressed air tools.



Higher Flow, Lower Pressure Drop

This symbol identifies all Quick Connect Couplers with an Ultra High Flow Valve. This flow-optimized valve ensures higher flow rates combined with lower pressure drop in your compressed air system. And thus helps to save energy.

Your advantages:

- Reduced energy requirements for compressed air preparation
- Better performance on compressed air tools
- Reduced waste in the system overall



Ultra High Flow Valve

This extremely streamlined high-end valve guarantees optimal flow and can be found in our „Energy Saving“ series e.g. 1600KA series. At nominal diameter 7.4, a flow of approx. 2,200 l/min (air) is therefore possible.



High Flow Valve

Due to less turbulence, this streamlined valve structure can increase flow by up to 80 % compared with conventional systems. This valve design can be found e.g. in our 25KA series. At nominal diameter 7.4, a flow of approx. 1,800 l/min (air) is therefore possible.



Standard Valve

For decades, the tried and tested valve technology with its robust and compact design has served reliably in many applications. This valve design can be found e.g. in our 26KA series. At nominal diameter 7.4, a flow of approx. 1,000 l/min (air) is therefore possible.

KNOW-HOW THAT SAVES HARD CASH.

In the age of rationalisation even in compressed air technology, the optimisation of systems is an important tool to improve energy efficiency. Correctly designed, complete systems from the compressor to the tool and a correctly dimensioned conduit system with no leaks save hard cash here. For over six decades now, we have devoted ourselves to the industrial handling of compressed air with professional systems and we are therefore intimately acquainted with the weak points of compressed air systems.

When planning a compressed air system, certain parameters must be kept in mind. As such, the hoses used should always be as short as possible and have the right diameter and as few coils as possible, as every metre of hose causes pressure losses. Even essentially correct, self-venting couplings sometimes differ considerably in terms of pressure loss. As such, modern systems reduce the pressure loss by at least a third, to approx. 0.2 bar, and therefore pay for themselves within a minimal period.

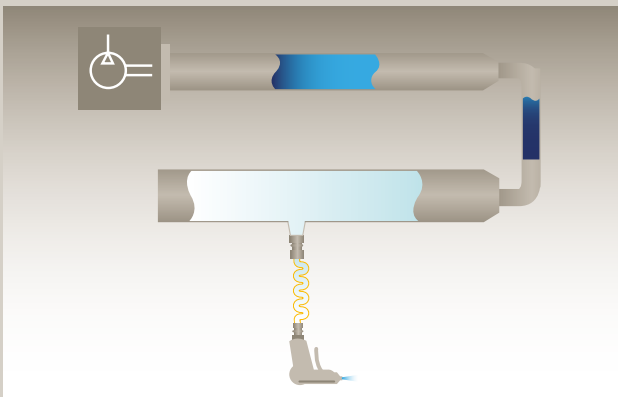

Incompatible Overall System

The objective evaluation of an existing system requires analysis of the actual condition of the system. The relevant parameters for this, such as volume flow, flow pressure and compressed air quality, can be recorded using professional measuring technology. Large cross-section tolerances, more couplings than necessary, too many nozzles and an incorrect hose diameter cost a huge amount of energy here. An appropriate assembly therefore always pays off, as efficient operation of the overall system is possible only if all components are in harmony.

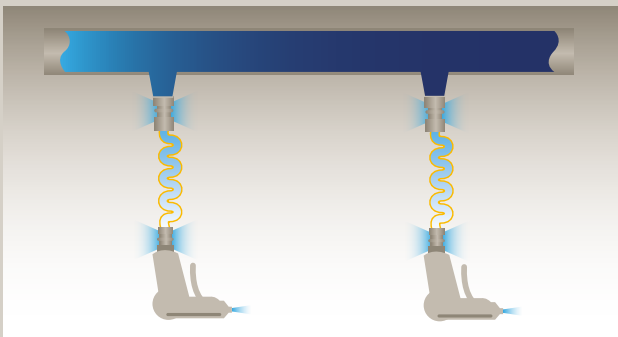

Leaks in the Connecting Elements

The detection of possible leaks in the network can be calculated either by back-feeding during down time or, if this is not possible, from the measured pressure curves during operation. Sensitive points here particularly include the connection to the ring line and to the tool. There is a possibility of optimisation for example with the use of quick connect couplings with a valve to prevent pressure loss when uncoupling and venting the system.

YOU KNOW YOUR APPLICATIONS, WE KNOW THE RIGHT COUPLING SYSTEM!

Industrial Sectors/ Application Areas	Straight-Through KF	Single Shut-Off KA	Double Shut-Off KB	Flat sealing Design KL	Thermoplastic Couplings POM/PVDF	Stainless Steel Couplings	Safety Couplings
Compressed Air	●	●	○	○	○	○	●
Air	●	●	○	○	○	○	●
Breathing Air	○	●	●	○	○	○	●
Gases	○	●	●	●	○	○	●
Liquid Gases	○	○	●	●	○	○	●
Water*	●	●	●	●	○	○	○
Liquid Media*	○	●	●	●	●	○	●
Aggressive Media	○	○	●	●	●	●	●
Chemicals	○	○	●	●	●	●	●
Machinery/Systems Manufacturing	○	●	○	●	○	○	●
Welding	○	●	○	○	○	○	○
Molding	●	●	●	○	○	○	○
Automation	○	●	○	○	○	○	○
Robotics	○	●	○	○	○	○	○
Textile Industry	○	●	○	○	○	○	○
Medical Equipment	●	●	●	●	●	●	●
Food and Beverage Industry	○	○	○	○	●	●	○
Chemical Industry	○	○	●	●	●	●	●
Pharmaceutical Industry	○	○	●	●	●	●	●
Laboratory	○	●	●	●	●	●	●
Analysis Technology	○	○	●	●	●	●	○
Steel Manufacturing	○	●	○	○	○	○	●
Rafineries	○	○	●	●	○	●	●
Paper Production	○	●	●	○	○	●	○
Rescue and Safety	○	●	●	●	○	●	●
Aerospace Technology	○	○	○	○	○	●	●
Shipyards	○	●	●	○	○	●	○
Semiconductor Technology	○	○	●	●	●	●	○
Laser Technology	○	○	●	●	○	●	○
Nuclear Power	○	○	●	○	○	●	●

* only systems with valve and sleeve made of brass

SEALING AND ACCURACY.

A coupling system is always as good as its sealing components. That is why we only use top quality, proven standards, which have been tried and tested time and again.

For special applications, please also ask our specialist advisers, as an important criterium for functionality of an O-ring is the type of medium in relation to its temperature.

The most important sealants

Sealingmaterial	Temperature range	Features
NBR Acrylonitrile-Butadiene Rubber	-20°C - +100°C	Can be used for compressed air. Resistant to heat and many liquids, e.g. mineral oils, fuel (no environmental diesel), water glycol and grease.
EPDM Ethylene Propylene Diene Rubber	-40°C - +150°C	Heat resistant and specially suited to hot water and steam. Good resistance to brake oils, glycol and fire-resistant oils. Not suitable for mineral-based oils and petrol.
FKM Fluorocarbon Rubber	-15°C - +200°C	Very high resistance to heat and liquids inc. petrol, oils, environmental diesel, grease and aromatic oils.
FFKM Perfluoro Rubber	-25°C - +240°C	Universal chemical resistance, good for aggressive media, high thermal resistance. Lowest source values for all media.

¹⁾ Viton® is a registered trademark of DuPont Dow Elastomers.

²⁾ Kalrez® is a registered trademark of DuPont Dow Elastomers.



RectuLoc

This innovative sealing method is available for all standard shut-off products with a tapered external thread. It consists of a sealant applied directly to the thread. The connection is simply merely screwed in and can be readjusted with no leakage even after several hours. It reliably seals against gases as well as aqueous and non-aqueous liquids up to 150 bar and temperatures up to 120°C and it is moreover also resistant to aggressive media.



Captive Washer

This permanently fixed sealing ring in robust polymer is available for all standard shut-off products with a cylindrical external thread. The connection is screwed as usual and reliably sealed by the ring, even in the case of readjustment. The seal is suitable for gaseous as well as aqueous and non-aqueous media up to a pressure of 150 bar and up to a temperature of 120°C as well as being resistant to aggressive media.

ALWAYS A SUITABLE PLUG.

Plug Profil: ISO6150 B

Standard-Series

Self-Venting Series



23SF
23KA/24KA
1400KA/1423KA
24KE/1400KE

30SF
30KA



37SF
37KA



Plug Profile: ISOC

Standard-Series

Self-Venting Series



303SB
303KB

18SF
18KA



84SF
84KA



Plug Profile: Europe

Standard-Series

Self-Venting Series



20SF
20KA



21SF
21KA



25SF*/26SF**
25KA/26KA/1600KA
1625KA
26KE/1600KE



27SF
27KA/1700KA
1727KA
1700KE

* Steel zinc plated
** Brass

Plug Profile: Walther

Standard-Series



50SF
50KA



51SF
51KA



52SF
52KA



57SF
57KA



Plug Profile: Scandinavia

Standard-Series



1100SF
1100KA



1300SF
1300KA



1800SF
1800KA



1900SF
1900KA



2100SF
2100KA

Plug Profile: Asia

Standard-Series



13SF
13KA

Plug Profile: Atlas Copco

Standard-Series



33SF
33KA



34SF
34KA

Plug Profile: Aro

Standard-Series

Self-Venting Series

22SF
14KA/22KA
14KE

Plug Profile: UK

Standard-Series

17SF
17KA

19SF
19KA

Pictures are smaller than actual products.

WE SET STANDARDS IN QUALITY AND SAFETY.

Around the world, highly qualified specialists work every day to guarantee and optimise the quality of our products. Nothing will deter them from the high demands they set themselves – as all employees know, we can retain our top international position only through constant top performance. With the aid of controlled manufacturing processes and the latest precision technology, it is the person – as a creative and experienced technician,

seller and customer adviser – who is responsible for this. All stages of production are subject to tried and tested, comprehensive quality management. The certificates and test reports from the principal independent institutions also confirm our outstanding functionality and production quality. For our customers, this means: greater safety and reliability – even under extreme conditions.



DIN EN ISO 9001:2000
Reg.Nr. 1070
Qualitätsmanagementsystem



FROM STANDARD PRODUCT TO BESPOKE SOLUTION.

Our standard catalogue range offers the right coupling system for most application areas. Many of these standard items come from previous special solutions, which we have subsequently integrated into series production. Developing special solutions for particular tasks is one of our strengths – and an advantage that you can use at any time. Our competent specialists will be happy to visit

you to establish your specific requirements and wishes. We will then recommend adaptation of one of our standard products or the new design of a bespoke, individual solution for you. Ultimately, we will provide you with a functional system that is exactly suited to your requirements – both technologically and economically. Talk to us! We will be happy to advise you in detail.



Standard

From nominal diameters 1.5 mm to 30 mm – from brass through stainless steel to plastic – various valve and seal types – sophisticated safety systems. Over the decades, we have developed one of the broadest ranges of standard coupling systems, which offer a solution for almost any application and can all be found in this catalogue.



Customised

Moreover, we develop systems designed very specifically for customer requirements. To this end, our experienced designers compile extensive requirement profiles and a functional specification together with the customer, in order to be able to develop the optimum solution. Simply talk to us about it!

SAFETY GUIDE FOR SELECTING AND USING QUICK CONNECT COUPLINGS AND RELATED ACCESSORIES

DANGER: failure or improper selection or improper use of quick connect couplings or related accessories can cause death, personal injury and property damage. Possible consequences of failure or

improper selection or improper use of quick connect couplings or related accessories include but are not limited to:

- Couplings or parts thrown off at high speed
- High velocity fluid discharge
- Contact with suddenly moving or falling objects that are to be held in position or moved by the conveyed fluid
- Dangerously whipping hose
- Explosion or burning of the conveyed fluid
- Contact with conveyed fluids that may be hot, cold, toxic, or otherwise injurious
- Sparking or explosion while paint or flammable liquid spraying

Before selecting or using any Parker RectusTema quick connect couplings or related accessories, it is important that you read and follow the following instructions.

1.0 GENERAL INSTRUCTIONS

1.1 Scope: this catalogue provides instructions for selecting and using (including installing connecting, disconnecting, and maintaining) quick connect couplings and related accessories (including caps, plugs, hoses, blow guns). This safety instruction is a supplement to and is to be used with the specific Parker publications for the specific quick connect couplings and related accessories that are being considered for use.

1.2 Fail-Safe: quick connect couplings or the hose they are attached to can fail without warning for many reasons. Design all systems and equipment in a fail-safe mode, so that failure of the quick connect coupling or hose will not endanger persons or property.

1.3 Distribution: provide a copy of this safety guide to each person who is responsible for selecting or using quick connect coupling products. Do not select or use quick connect couplings without thoroughly reading and understanding this safety guide as well as the specific Parker publications for the products considered or selected.

1.4 User responsibility: due to the wide variety of operating conditions and uses for quick connect couplings, Parker RectusTema and its distributors do not represent or warrant that any particular coupling system is suitable for any specific end use system. This safety instructions do not analyse all technical parameters that must be considered in selecting a product. The user, through its own analysis and testing, is solely responsible for:

- Making the final selection of the quick connect couplings.
- Assuring that the user's requirements are met and that the use presents no health or safety hazards.
- Providing all appropriate health and safety warnings on the equipment on which the quick connect couplings are used.

1.5 Additional questions: call the appropriate Parker customer service department if you have any questions or require any additional information. For the telephone numbers of the appropriate customer service department, see the Parker publication for the product being considered or used.

2.0 SELECTION INSTRUCTIONS

2.1 Pressure: quick connect couplings selection must be made so that the published rated pressure of the coupling is equal to or greater than the maximum system pressure. Pressure surges in the system higher than the rated pressure of the coupling will shorten the quick connect coupling's life. Do not confuse burst pressure or other pressure values with rated pressure and do not use burst pressure or other pressure values for this purpose.

2.2 Fluid compatibility: quick connect couplings selection must assure compatibility of the body and seal materials with the fluid media used. See the fluid compatibility chart.

2.3 Leakage rate: Plug and Coupling connected: $4,0 \times 10^{-4}$ mbar³/s, Plug disconnected: $< 10^{-6}$ mbar³/s, Coupling disconnected: $< 10^{-6}$ mbar³/s

2.4 Temperature: be certain that fluid and ambient temperatures, both steady and transient, do not exceed the limitations of the quick connect couplings. Use caution and hand protection when connecting or disconnecting quick connect couplings that are heated or cooled by the media they are conducting or by their environment.

2.5 Size: transmission or power by means of pressurised liquid varies with pressure and rate of flow. The size of the quick connect couplings and other components of the system must be adequate to keep pressure losses to a minimum and avoid damage due to heat generation or excessive fluid velocity.

2.6 Pressurised connection or disconnection: if connecting or disconnecting under pressure is a requirement, use only quick connect couplings designed for that purpose. The rated operating pressure of a quick connect coupling may not be the pressure at which it may be safely connected or disconnected.

2.7 Environment: care must be taken to ensure that quick connect couplings are either compatible with or protected from the environment (that is, surrounding conditions) to which they are exposed. Environmental conditions including but not limited to ultraviolet radiation, ozone, moisture, water, salt water, chemicals, and air pollutants can cause degradation and premature failure.



2.8 Locking means: ball locking quick connect couplings can unintentionally disconnect if they are dragged over obstructions on the end of a hose or if the sleeve is bumped or moved enough to cause disconnection. Sleeves designed with flanges to provide better gripping for oily or gloved hands are especially susceptible to accidental disconnection and should not be used where these conditions exist. Sleeve lock or union (threaded) sleeve designs should be considered where there is a potential for accidental uncoupling.

2.9 Mechanical loads: external forces can significantly reduce quick connect couplings' life or cause failure. Mechanical loads which must be considered include excessive tensile or side loads and vibration. Unusual applications may require special testing prior to quick connect couplings selection.

2.10 Specifications and standards: when selecting quick connect couplings, government, industry and Parker specifications must be reviewed and followed as applicable.

2.11 Vacuum: not all quick connect couplings are suitable or recommended for vacuum service. Quick connect couplings used for vacuum applications must be selected to ensure that the quick connect couplings will withstand the vacuum and pressure of the system.

2.12 Fire resistant fluids: some fire resistant fluids require seals other than the standard NBR (nitrile) used in many coupling systems.

2.13 Radiant heat: quick connect couplings can be heated to destruction or loss of sealing without contact by such nearby items as hot manifolds or molten metal. The same heat source may then initiate a fire. This can occur despite the presence of cool air around the quick connect couplings.

2.14 Welding and brazing: heating of plated parts, including quick connect couplings and port adapters, above 450 °F (232 °C) such as during welding, brazing, or soldering may emit deadly gases and may cause coupling seal damage.

3.0 INSTALLATION INSTRUCTIONS

3.1 Pre-installation inspection: before installing a quick connect coupling, visually inspect it and check for correct style, body material, seal material, and catalogue number. Before final installation, coupling halves should be connected and disconnected with a sample of the mating half with which they will be used.

3.2 Quick connect coupling halves from other manufacturers: if a quick connect coupling assembly is made up of one Parker RectusTema half and one half from another manufacturer, the lowest pressure rating of the two halves should not be exceeded.

3.3 Fitting installation: use a thread sealant, when assembling taper pipe thread joints in quick connect couplings. Be sure the sealant is compatible with the system fluid or gas. To avoid system contamination, use a liquid or paste type sealant rather than a tape style. Use the flats provided to hold the quick connect coupling when installing fittings. Do not use pipe wrenches or a vice on other parts of the coupling to hold it when installing or a removing fittings as damage or loosening of threaded joints in the coupling assembly could result. Do not apply excessive torque to taper pipe threads because cracking or splitting of the female component can result.

3.4 Caps and plugs: use dust caps and plugs when quick connect couplings are not coupled to exclude dirt and contamination and to protect critical surfaces from damage.

3.5 Coupling location: locate quick connect couplings where they can be reached for connection or disconnection without exposing the operator to slipping, falling, getting sprayed or coming in contact with hot or moving parts.

3.6 Hose whips: use a hose whip (a short length of hose between the tool and the coupling half) instead of rigidly mounting a coupling half on hand tools or other devices. This reduces the potential for coupling damage if the tool is dropped and provides some isolation from mechanical vibration which could cause uncoupling.

4.0 MAINTENANCE INSTRUCTIONS

4.1 Even with proper selection and installation, quick connect coupling life may be significantly reduced without a continuing maintenance program. Frequency should be determined by the severity of the application and risk potential. A maintenance program must be established and followed by the user and must include the following as a minimum:

4.2 Visual inspection of quick connect couplings: any of the following conditions require immediate shut down and replacement of the quick connect coupling:

- Cracked, damaged, or corroded quick connect couplings parts.
- Leaks at the fitting, valve or mating seal.
- Broken coupling mounting hardware, especially breakaway clamps.

4.3 Visual inspection all other:

- Leaking seals or port connections.
- Excess dirt build-up on the coupling locking means or on the interface area of either coupling half.
- Defective clamps, guards, and shields.
- System fluid level, fluid type and any entrapment.

4.4 Functional test: operate the system at maximum operating pressure and check for possible malfunctions and freedom from leaks. Personnel must avoid potential hazardous areas while testing and using the system.

4.5 Replacement intervals: specific replacement intervals must be considered based on previous service life, government or industry recommendations, or when failures could result in unacceptable downtime, damage or injury risk. See instruction 1.2 above.

Nominal Diameter

1,5 = 1,8 mm²

Rectus Series

02

Smallest mini industrial coupling for air and gas applications. Primarily in medicine, didactics and model building. Specific application for liquids due to size. Coupling system with single-hand operation. Extremely small dimensions.

Series 02 in brass material without nickel plating and with additional end connections available on request.

Working Temperature*

-20°C up to +100°C (NBR)
depending on the medium.

* For temperatures below -20°C and over +100°C and depending on the medium, other seal variants (FKM, EPDM, FFKM) are available.

**Working Pressure****

35 bar

** maximum static working pressure with design factor 4 to 1.

Material

Coupling: Brass nickel plated

Plug: Brass nickel plated

Seals: NBR

Technical Description

Connecting Force 0 bar: 7 N

Connecting Force 6 bar: 19 N

Vacuum Coupling: 96%

Vacuum connected: 96%

Interchangeability (KA only)

- Rectus Design

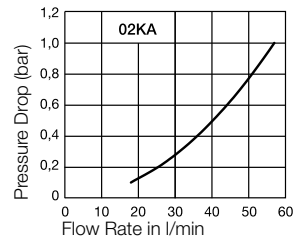
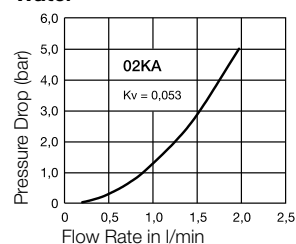
Flow diagrams**Air****Water**



Couplings – with valve

Series 02KA

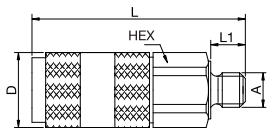
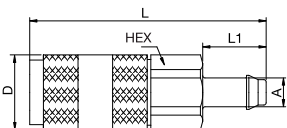
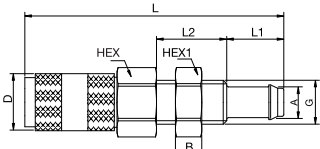
	Connection A	HEX mm	HEX1 mm	L mm	L1 mm	L2 mm	D mm	B mm	G mm	Part Number
 <p>Male Thread</p>	M 3	6		19	3		6,5			02KAAM03MPN
 <p>Hose Barb</p>	2 mm	6		21	5,5		6,5			02KATF02MPN
	3 mm	6		22	5,5		6,5			02KATF03MPN
 <p>Panel Mount with Hose Barb</p>	2 mm	7	7	29	5,5	8	6,5	3	M 5	02KATS02MPN
	3 mm	7	7	30	6,5	8	6,5	3	M 5	02KATS03MPN



Plugs – without valve

Series 02KA

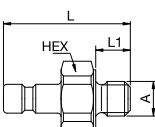
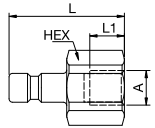
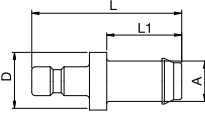
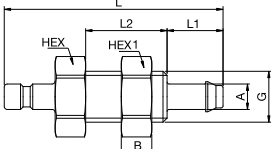
	Connection A	HEX mm	HEX1 mm	L mm	L1 mm	L2 mm	D mm	B mm	G mm	Part Number
 <p>Male Thread</p>	M 3	6		11	3					02SFAM03MXN
 <p>Female Thread</p>	M 3	6		10	3					02SFIM03MXN
 <p>Hose Barb</p>	2 mm			12	5,5		4			02SFTF02MXN
 <p>Panel Mount with Hose Barb</p>	2 mm	7	7	22	5,5	8		3	M 5	02SFTS02MXN

Nominal Diameter

2,5 = 5 mm²

Rectus Series

50

Mini industrial coupling, can be used with various media.
Coupling system with single-hand operation. This system is extremely easy to operate and stands out for its small installation dimensions.

Series 50 in brass material with nickel plating and with additional end connections available on request.

Working Temperature*

-20°C up to +100°C (NBR)
depending on the medium.

* For temperatures below -20°C and over +100°C and depending on the medium, other seal variants (FKM, EPDM, FFKM) are available.

**Working Pressure****

35 bar

** maximum static working pressure with design factor 4 to 1.

Material

Coupling: Brass

Plug: Brass

Seals: NBR

Technical Description

Connecting Force 0 bar: 31 N

Connecting Force 6 bar: 49 N

Interchangeability (KA only)

- Walther LP002

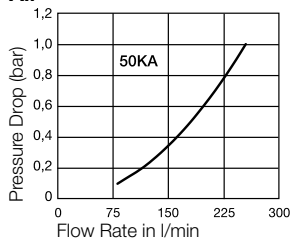
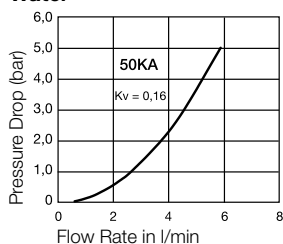
Flow diagrams**Air****Water**



Couplings – with valve

Series 50KA

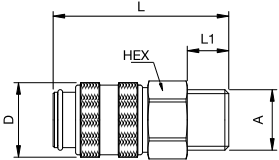
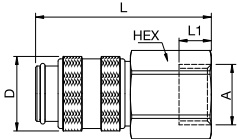
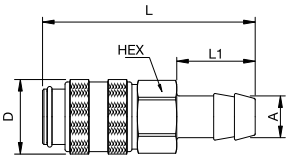
	Connection A	HEX mm	L mm	L1 mm	D mm	Part Number
 <p>Male Thread</p>	G 1/8	14	36	7	16	50KAAW10MPXS
	G 1/4	17	38	9	16	50KAAW13MPXS
 <p>Female Thread</p>	G 1/8	14	36	9	16	50KAIW10MPXS
	G 1/4	17	38	9	16	50KAIW13MPXS
 <p>Hose Barb</p>	4 mm	14	46	17	16	50KATF04MPXS
	6 mm	14	46	17	16	50KATF06MPXS



Plugs – without valve

Series 50KA

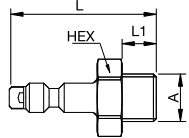
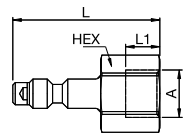
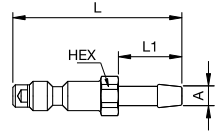
	Connection A	HEX mm	L mm	L1 mm	D mm	Part Number
 <p>Male Thread</p>	G 1/8	14	30	7		50SFAW10MXX
 <p>Female Thread</p>	G 1/8	14	30	7		50SFIW10MXX
 <p>Hose Barb</p>	4 mm	7	35	13		50SFTF04MXX
	6 mm	7	35	13		50SFTF06MXX



Other designs in series 20

The following other designs can be found from page:

- Stainless Steel P. 132

Mini industrial coupling with internationally used profile. Frequent use in medical technology and chemistry/pharmacy. Coupling system with single-hand operation. High flow despite small dimensions plus many applications with a variety of media.

Series 20 with additional end connections available on request.

Working Temperature*

-20°C up to +100°C (NBR) depending on the medium.

* For temperatures below -20°C and over +100°C and depending on the medium, other seal variants (FKM, EPDM, FFKM) are available.



Working Pressure**

35 bar
** maximum static working pressure with design factor 4 to 1.

35 bar

Features

- Low pressure drop

Material

Coupling: Brass
Plug: Brass
Seals: NBR

Coupling: Brass
Plug: Brass
Seals: NBR

Technical Description

Connecting Force 0 bar: 25 N
Connecting Force 6 bar: 35 N

Connecting Force 0 bar: 25 N
Connecting Force 6 bar: 35 N

Vacuum Coupling: 96%
Vacuum connected: 96%

Vacuum Coupling: 96%
Vacuum Plug: 96%
Vacuum connected: 96%

Interchangeability (KA only)

- Walther 06-003

Flow diagrams

Air

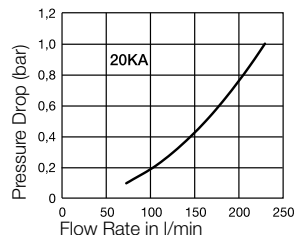

Air

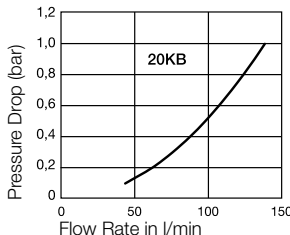

Water

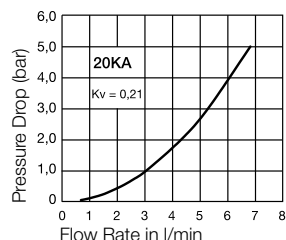

Water

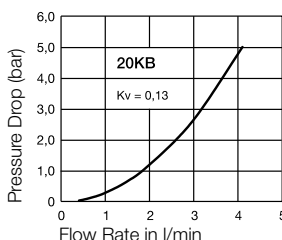

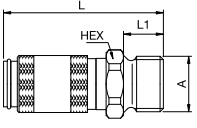
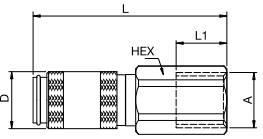
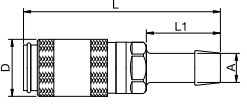
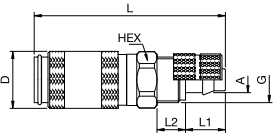
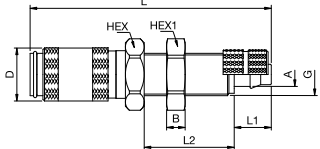
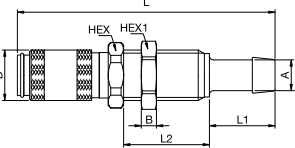
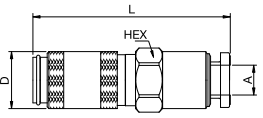

	Connection A	HEX mm	HEX1 mm	L mm	L1 mm	L2 mm	D mm	B mm	G mm	Version	Part Number
 <p>Male Thread</p>	M 5	9		26	5		10			blank	20KAAM05MPX
	M 5	9		26	5		10			nickel plated	20KAAM05MPN
	G 1/8	11		28	7		10			blank	20KAAW10MPX
	G 1/8	11		28	7		10			nickel plated	20KAAW10MPN
 <p>Female Thread</p>	M 5	9		26	5		10			blank	20KAIM05MPX
	M 5	9		26	5		10			nickel plated	20KAIM05MPN
	G 1/8	12		28	7		10			blank	20KAIW10MPX
	G 1/8	12		28	7		10			nickel plated	20KAIW10MPN
 <p>Hose Barb</p>	3 mm			35	13		10			blank	20KATF03MPX
	3 mm			35	13		10			nickel plated	20KATF03MPN
	4 mm			35	13		10			blank	20KATF04MPX
	4 mm			35	13		10			nickel plated	20KATF04MPN
	5 mm			34	13		10			blank	20KATF05MPX
	5 mm			34	13		10			nickel plated	20KATF05MPN
 <p>with Plastic Hose Connection</p>	3 x 4 mm	9		34	7	5	10		M 7 x 0,5	blank	20KAKO04MPX
	3 x 4 mm	9		34	7	5	10		M 7 x 0,5	nickel plated	20KAKO04MPN
	3 x 5 mm	9		34	7	5	10		M 7 x 0,5	blank	20KAKO05MPX
	3 x 5 mm	9		34	7	5	10		M 7 x 0,5	nickel plated	20KAKO05MPN
	4 x 6 mm	9		34	7	5	10		M 8 x 0,5	blank	20KAKO06MPX
	4 x 6 mm	9		34	7	5	10		M 8 x 0,5	nickel plated	20KAKO06MPN
 <p>Panel Mount with Plastic Hose Connection</p>	3 x 4 mm	12	11	45	7	17	10	3	M 7 x 0,5	blank	20KAKS04MPX
	3 x 4 mm	12	11	45	7	17	10	3	M 7 x 0,5	nickel plated	20KAKS04MPN
	3 x 5 mm	12	11	45	7	17	10	3	M 7 x 0,5	blank	20KAKS05MPX
	3 x 5 mm	12	11	45	7	17	10	3	M 7 x 0,5	nickel plated	20KAKS05MPN
	4 x 6 mm	12	11	45	7	12	10	3	M 8 x 0,5	blank	20KAKS06MPX
	4 x 6 mm	12	11	45	7	12	10	3	M 8 x 0,5	nickel plated	20KAKS06MPN
 <p>Panel Mount with Hose Barb</p>	3 mm	12	11	51	13	17	10	3	M 7 x 0,5	blank	20KATS03MPX
	3 mm	12	11	51	13	17	10	3	M 7 x 0,5	nickel plated	20KATS03MPN
	4 mm	12	11	51	13	17	10	3	M 7 x 0,5	blank	20KATS04MPX
	4 mm	12	11	51	13	17	10	3	M 7 x 0,5	nickel plated	20KATS04MPN
 <p>Push-In</p>	4 mm	10		35			10			nickel plated	20KARP04MPN



Plugs – without valve

Series 20KA

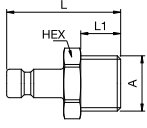
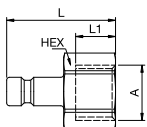
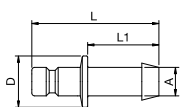
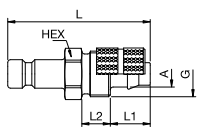
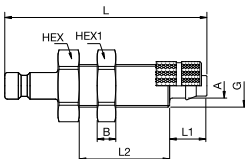
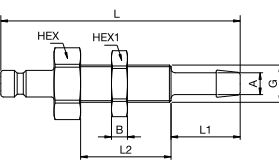
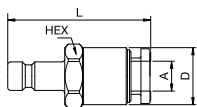
	Connection A	HEX mm	HEX1 mm	L mm	L1 mm	L2 mm	D mm	B mm	G mm	Version	Part Number
 <p>Male Thread</p>	M 5	7		18	5					blank	20SFAM05MXX
	M 5	7		18	5					nickel plated	20SFAM05MXN
	G 1/8	11		20	7					blank	20SFAW10MXX
	G 1/8	11		20	7					nickel plated	20SFAW10MXN
 <p>Female Thread</p>	M 5	7		17	5					blank	20SFIM05MXX
	M 5	7		17	5					nickel plated	20SFIM05MXN
	G 1/8	12		19	7					blank	20SFIW10MXX
	G 1/8	12		19	7					nickel plated	20SFIW10MXN
 <p>Hose Barb</p>	3 mm			24	13		7			blank	20SFTF03MXX
	3 mm			24	13		7			nickel plated	20SFTF03MXN
	4 mm			24	13		7			blank	20SFTF04MXX
	4 mm			24	13		7			nickel plated	20SFTF04MXN
	5 mm			22	13		9			blank	20SFTF05MXX
	5 mm			22	13		9			nickel plated	20SFTF05MXN
 <p>with Plastic Hose Connection</p>	3 x 4 mm	7		25	7	5			M 7 x 0,5	blank	20SFKO04MXX
	3 x 4 mm	7		25	7	5			M 7 x 0,5	nickel plated	20SFKO04MXN
	3 x 5 mm	7		25	7	5			M 7 x 0,5	blank	20SFKO05MXX
	3 x 5 mm	7		25	7	5			M 7 x 0,5	nickel plated	20SFKO05MXN
	4 x 6 mm	8		25	7	5			M 8 x 0,5	blank	20SFKO06MXX
	4 x 6 mm	8		25	7	5			M 8 x 0,5	nickel plated	20SFKO06MXN
 <p>Panel Mount with Plastic Hose Connection</p>	3 x 4 mm	11	11	38	7	17		3	M 7 x 0,5	blank	20SFKS04MXX
	3 x 4 mm	11	11	38	7	17		3	M 7 x 0,5	nickel plated	20SFKS04MXN
	3 x 5 mm	11	11	38	7	17		3	M 7 x 0,5	blank	20SFKS05MXX
	3 x 5 mm	11	11	38	7	17		3	M 7 x 0,5	nickel plated	20SFKS05MXN
	4 x 6 mm	12	12	38	7	17		3	M 8 x 0,5	blank	20SFKS06MXX
	4 x 6 mm	12	12	38	7	17		3	M 8 x 0,5	nickel plated	20SFKS06MXN
 <p>Panel Mount with Hose Barb</p>	3 mm	12	11	45	13	18		3,5	M 7 x 0,5	blank	20SFTS03MXX
	3 mm	12	11	45	13	18		3,5	M 7 x 0,5	nickel plated	20SFTS03MXN
	4 mm	12	11	45	13	17		3	M 7 x 0,5	blank	20SFTS04MXX
	4 mm	12	11	45	13	17		3	M 7 x 0,5	nickel plated	20SFTS04MXN
 <p>Push-In</p>	4 mm	10		35			10			nickel plated	20SFRP04MPN

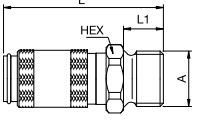
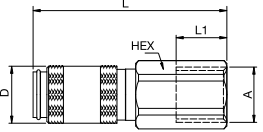
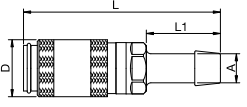
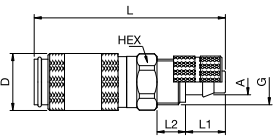
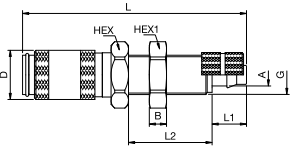
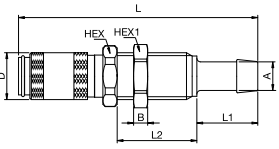

	Connection A	HEX mm	HEX1 mm	L mm	L1 mm	L2 mm	D mm	B mm	G mm	Version	Part Number
 <p>Male Thread</p>	M 5	9		26	5		10			blank	20KBAM05MPX
	M 5	9		26	5		10			nickel plated	20KBAM05MPN
	G 1/8	11		28	7		10			blank	20KBAW10MPX
	G 1/8	11		28	7		10			nickel plated	20KBAW10MPN
 <p>Female Thread</p>	M 5	9		26	5		10			blank	20KBIM05MPX
	M 5	9		26	5		10			nickel plated	20KBIM05MPN
	G 1/8	12		28	7		10			blank	20KBIW10MPX
	G 1/8	12		28	7		10			nickel plated	20KBIW10MPN
 <p>Hose Barb</p>	3 mm			35	13		10			blank	20KBTF03MPX
	3 mm			35	13		10			nickel plated	20KBTF03MPN
	4 mm			35	13		10			blank	20KBTF04MPX
	4 mm			35	13		10			nickel plated	20KBTF04MPN
	5 mm			34	13		10			blank	20KBTF05MPX
	5 mm			34	13		10			nickel plated	20KBTF05MPN
 <p>with Plastic Hose Connection</p>	3 x 4 mm	9		34	7	5	10		M 7 x 0,5	blank	20KBKO04MPX
	3 x 4 mm	9		34	7	5	10		M 7 x 0,5	nickel plated	20KBKO04MPN
	3 x 5 mm	9		34	7	5	10		M 7 x 0,5	blank	20KBKO05MPX
	3 x 5 mm	9		34	7	5	10		M 7 x 0,5	nickel plated	20KBKO05MPN
	4 x 6 mm	9		34	7	5	10		M 8 x 0,5	blank	20KBKO06MPX
	4 x 6 mm	9		34	7	5	10		M 8 x 0,5	nickel plated	20KBKO06MPN
 <p>Panel Mount with Plastic Hose Connection</p>	3 x 4 mm	12	11	45	7	17	10	3	M 7 x 0,5	blank	20KBKS04MPX
	3 x 4 mm	12	11	45	7	17	10	3	M 7 x 0,5	nickel plated	20KBKS04MPN
	3 x 5 mm	12	11	45	7	17	10	3	M 7 x 0,5	blank	20KBKS05MPX
	3 x 5 mm	12	11	45	7	17	10	3	M 7 x 0,5	nickel plated	20KBKS05MPN
	4 x 6 mm	12	12	45	7	17	10	3,5	M 8 x 0,5	blank	20KBKS06MPX
	4 x 6 mm	12	12	45	7	17	10	3,5	M 8 x 0,5	nickel plated	20KBKS06MPN
 <p>Panel Mount with Hose Barb</p>	3 mm	12	11	51	13	17	10	3	M 7 x 0,5	blank	20KBTS03MPX
	3 mm	12	11	51	13	17	10	3	M 7 x 0,5	nickel plated	20KBTS03MPN
	4 mm	12	11	51	13	17	10	3	M 7 x 0,5	blank	20KBTS04MPX
	4 mm	12	11	51	13	17	10	3	M 7 x 0,5	nickel plated	20KBTS04MPN



Plugs – with valve

Series 20KB

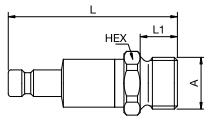
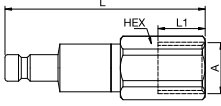
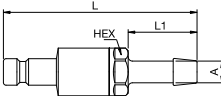
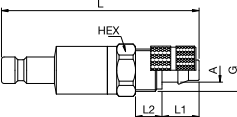
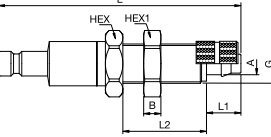
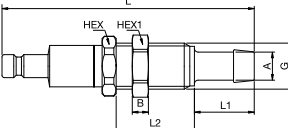
	Connection A	HEX mm	HEX1 mm	L mm	L1 mm	L2 mm	D mm	B mm	G mm	Version	Part Number
 <p>Male Thread</p>	M 5	9		28	5					blank	20SBAM05MPX
	M 5	9		28	5					nickel plated	20SBAM05MPN
	G 1/8	11		30	7					blank	20SBAW10MPX
	G 1/8	11		30	7					nickel plated	20SBAW10MPN
 <p>Female Thread</p>	M 5	9		26	5					blank	20SBIM05MPX
	M 5	9		26	5					nickel plated	20SBIM05MPN
	G 1/8	12		30	7					blank	20SBIW10MPX
	G 1/8	12		30	7					nickel plated	20SBIW10MPN
 <p>Hose Barb</p>	3 mm	8		36	13					blank	20SBTF03MPX
	3 mm	8		36	13					nickel plated	20SBTF03MPN
	4 mm	8		36	13					blank	20SBTF04MPX
	4 mm	8		36	13					nickel plated	20SBTF04MPN
	5 mm	8		36	13					blank	20SBTF05MPX
	5 mm	8		36	13					nickel plated	20SBTF05MPN
 <p>with Plastic Hose Connection</p>	3 x 4 mm	9		30,5	7	5			M 7 x 0,5	blank	20SBKO04MPX
	3 x 4 mm	9		30,5	7	5			M 7 x 0,5	nickel plated	20SBKO04MPN
	3 x 5 mm	9		30,5	7	5			M 7 x 0,5	blank	20SBKO05MPX
	3 x 5 mm	9		30,5	7	5			M 7 x 0,5	nickel plated	20SBKO05MPN
	4 x 6 mm	9		30,5	7	5			M 8 x 0,5	blank	20SBKO06MPX
	4 x 6 mm	9		30,5	7	5			M 8 x 0,5	nickel plated	20SBKO06MPN
 <p>Panel Mount with Plastic Hose Connection</p>	3 x 4 mm	12	11	46,5	7	17		3	M 7 x 0,5	blank	20SBKS04MPX
	3 x 4 mm	12	11	46,5	7	17		3	M 7 x 0,5	nickel plated	20SBKS04MPN
	3 x 5 mm	12	11	46,5	7	17		3	M 7 x 0,5	blank	20SBKS05MPX
	3 x 5 mm	12	11	46,5	7	17		3	M 7 x 0,5	nickel plated	20SBKS05MPN
	4 x 6 mm	12	12	46,5	7	17		3,5	M 8 x 0,5	blank	20SBKS06MPX
	4 x 6 mm	12	12	46,5	7	17		3,5	M 8 x 0,5	nickel plated	20SBKS06MPN
 <p>Panel Mount with Hose Barb</p>	3 mm	12	11	52,5	13	17		3	M 7 x 0,5	blank	20SBTS03MPX
	3 mm	12	11	52,5	13	17		3	M 7 x 0,5	nickel plated	20SBTS03MPN
	4 mm	12	11	52,5	13	17		3	M 7 x 0,5	blank	20SBTS04MPX
	4 mm	12	11	52,5	13	17		3	M 7 x 0,5	nickel plated	20SBTS04MPN

5 = 20 mm²**17**

Brass/steel industrial coupling with English profile specifically suited to compressed air applications in industry.

Coupling system with single-hand operation. High Flow valve for optimum flow and low pressure drop. Versatile due to slim design and light weight.

Series 17 with additional end connections available on request.

Working Temperature*

-20°C up to +100°C (NBR)
depending on the medium.

* For temperatures below -20°C and over +100°C and depending on the medium, other seal variants (FKM, EPDM, FFKM) are available.

**Working Pressure****

35 bar

** maximum static working pressure with design factor 4 to 1.

Material

Coupling: Brass nickel plated,
Steel zinc plated

Plug: Steel nickel plated

Seals: NBR

Technical Description

Connecting Force 0 bar: 35 N

Connecting Force 6 bar: 115 N

Vacuum Coupling: 96%

Vacuum connected: 96%

Interchangeability (KA only)

- Schrader DN 5

Flow diagrams

Air

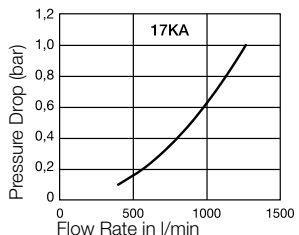



Couplings – with valve

Series 17KA

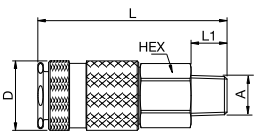
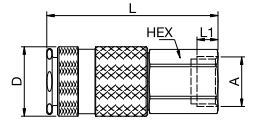
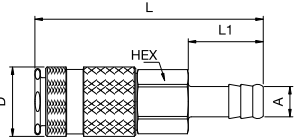
	Connection A	HEX mm	L mm	L1 mm	D mm	Part Number
 <p>Male Thread</p>	R 1/4	19	63	12	23	17KAAK13SPN
	R 3/8	19	62	12	23	17KAAK17SPN
	R 1/2	22	63	17	23	17KAAK21SPN
 <p>Female Thread</p>	G 1/4	19	58	9	23	17KAIW13SPN
	G 3/8	19	57	9	23	17KAIW17SPN
	G 1/2	24	60	12	23	17KAIW21SPN
 <p>Hose Barb</p>	6 mm	19	76	25	23	17KATF06SPN
	8 mm	19	76	25	23	17KATF08SPN
	10 mm	19	76	25	23	17KATF10SPN
	13 mm	19	76	25	23	17KATF13SPN



Plugs – without valve

Series 17KA

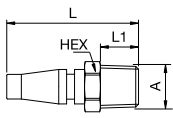
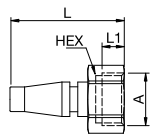
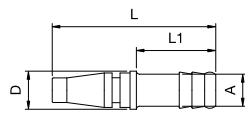
	Connection A	HEX mm	L mm	L1 mm	D mm	Part Number
 <p>Male Thread</p>	R 1/8	11	37	9		17SFAK10SXN
	R 1/4	14	42	12		17SFAK13SXN
 <p>Female Thread</p>	G 1/8	14	33	7		17SFIW10SXN
	G 1/4	17	36	9		17SFIW13SXN
 <p>Hose Barb</p>	6 mm		58	25	12	17SFTF06SXN
	8 mm		52	25	12	17SFTF08SXN
	10 mm		52	25	12	17SFTF10SXN



Mini industrial coupling with the world's most popular profile in this nominal diameter. Above average flow performance for liquid and gaseous media. Coupling system with single-hand operation. Small dimensions and large band width in materials and valve variants.

Series 21 with additional end connections available on request.

Dust Protections  (P. 250) for Coupling Part.-No. SK16S

Working Temperature*
-20°C up to +100°C (NBR) depending on the medium.

* For temperatures below -20°C and over +100°C and depending on the medium, other seal variants (FKM, EPDM, FFKM) are available.



Other designs in series 21

The following other designs can be found from page:

- ▶ Stainless Steel P. 140
- ▶ Thermoplastic P. 176
- ▶ Safety P. 210
- ▶ Coded Systems P. 234

Interchangeability (KA only)

- Camozzi
- Ewo
- Kani

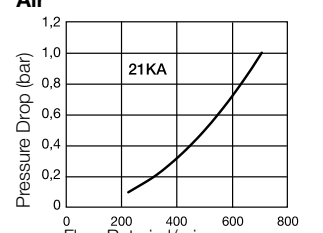
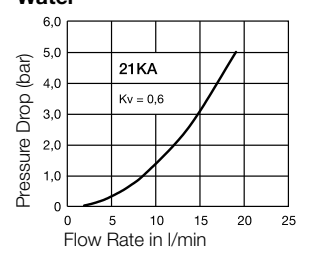
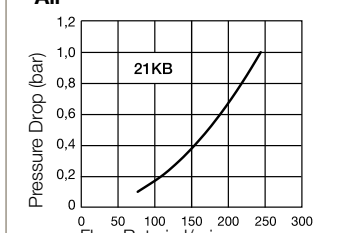
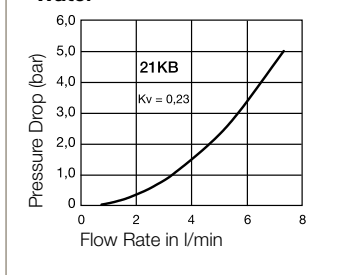
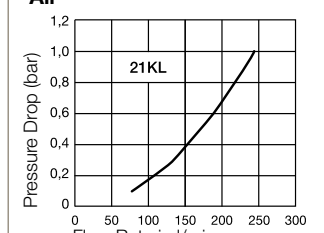
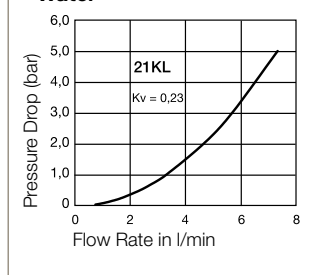
		
<p>Working Pressure** 35 bar ** maximum static working pressure with design factor 4 to 1.</p>	<p>35 bar</p>	<p>8 bar</p>
<p>Features</p> <ul style="list-style-type: none"> • Minimal, almost imperceptible leakage when uncoupling • No air locked into the system during the coupling process 		
<p>Material Coupling: Brass Plug: Brass Seals: NBR</p>		
<p>Technical Description Connecting Force 0 bar: 35 N Connecting Force 6 bar: 60 N Vacuum Coupling: 96% Vacuum connected: 96%</p>		
<p>Flow diagrams</p> <p>Air</p>  <p>Water</p> 	<p>Flow diagrams</p> <p>Air</p>  <p>Water</p> 	<p>Flow diagrams</p> <p>Air</p>  <p>Water</p> 



	Connection A	HEX mm	HEX1 mm	L mm	L1 mm	L2 mm	D mm	B mm	G mm	Version	Part Number
<p>Male Thread</p>	G 1/8	14		36	7		16			blank	21KAAW10MPX
	G 1/8	14		36	7		16			nickel plated	21KAAW10MPN
	G 1/4	17		38	9		16			blank	21KAAW13MPX
	G 1/4	17		38	9		16			nickel plated	21KAAW13MPN
	G 3/8	19		38	9		16			blank	21KAAW17MPX
	G 3/8	19		38	9		16			nickel plated	21KAAW17MPN
	M 12 x 1,5	17		39	10		16			blank	21KAAD12MPX
	M 12 x 1,5	17		39	10		16			nickel plated	21KAAD12MPN
	M 14 x 1,5	17		39	10		16			blank	21KAAD14MPX
	M 14 x 1,5	17		39	10		16			nickel plated	21KAAD14MPN
<p>Female Thread</p>	G 1/8	14		36	9		16			blank	21KAIW10MPX
	G 1/8	14		36	9		16			nickel plated	21KAIW10MPN
	G 1/4	17		38	9		16			blank	21KAIW13MPX
	G 1/4	17		38	9		16			nickel plated	21KAIW13MPN
	G 3/8	19		38	9		16			blank	21KAIW17MPX
	G 3/8	19		38	9		16			nickel plated	21KAIW17MPN
	M 12 x 1,5	17		38	6		16			blank	21KAIM12MPX
	M 12 x 1,5	17		38	6		16			nickel plated	21KAIM12MPN
	M 14 x 1,5	17		38	6		16			blank	21KAIM14MPX
	M 14 x 1,5	17		38	6		16			nickel plated	21KAIM14MPN
<p>Hose Barb</p>	4 mm	14		46	17		16			blank	21KATF04MPX
	4 mm	14		46	17		16			nickel plated	21KATF04MPN
	6 mm	14		46	17		16			blank	21KATF06MPX
	6 mm	14		46	17		16			nickel plated	21KATF06MPN
	8 mm	14		46	17		16			blank	21KATF08MPX
	8 mm	14		46	17		16			nickel plated	21KATF08MPN
	9 mm	14		46	17		16			blank	21KATF09MPX
	9 mm	14		46	17		16			nickel plated	21KATF09MPN
	10 mm	14		46	17		16			blank	21KATF10MPX
	10 mm	14		46	17		16			nickel plated	21KATF10MPN
<p>with Plastic Hose Connection</p>	4 x 6 mm	14		42	7	6	16	M 10 x 1		blank	21KAKO06MPX
	4 x 6 mm	14		42	7	6	16	M 10 x 1		nickel plated	21KAKO06MPN
	6 x 8 mm	14		42	7	6	16	M 12 x 1		blank	21KAKO08MPX
	6 x 8 mm	14		42	7	6	16	M 12 x 1		nickel plated	21KAKO08MPN



Couplings – with valve

Series 21KA

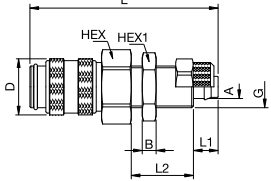
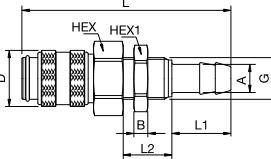
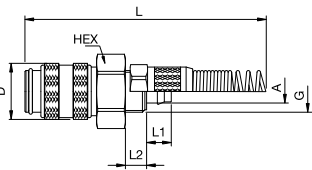
	Connection A	HEX mm	HEX1 mm	L mm	L1 mm	L2 mm	D mm	B mm	G mm	Version	Part Number
 <p>Panel Mount with Plastic Hose Connection</p>	4 x 6 mm	14	12	54	7	18	16	3	M 10 x 1	blank	21KAKS06MPX
	4 x 6 mm	14	12	54	7	18	16	3	M 10 x 1	nickel plated	21KAKS06MPN
	6 x 8 mm	17	17	54	7	18	16	4	M 12 x 1	blank	21KAKS08MPX
	6 x 8 mm	17	17	54	7	18	16	4	M 12 x 1	nickel plated	21KAKS08MPN
 <p>Panel Mount with Hose Barb</p>	4 mm	12	12	60	17	14	16	4	M 10 x 1	blank	21KATS04MPX
	4 mm	12	12	60	17	14	16	4	M 10 x 1	nickel plated	21KATS04MPN
	5 mm	17	17	60	17	14	16	4	M 12 x 1	blank	21KATS05MPX
	5 mm	17	17	60	17	14	16	4	M 12 x 1	nickel plated	21KATS05MPN
	6 mm	17	17	60	17	14	16	4	M 12 x 1	blank	21KATS06MPX
	6 mm	17	17	60	17	14	16	4	M 12 x 1	nickel plated	21KATS06MPN
	8 mm	17	17	60	17	14	16	4	M 12 x 1	blank	21KATS08MPX
	8 mm	17	17	60	17	14	16	4	M 12 x 1	nickel plated	21KATS08MPN
	9 mm	17	19	60	17	14	16	4	M 14 x 1	blank	21KATS09MPX
	9 mm	17	19	60	17	14	16	4	M 14 x 1	nickel plated	21KATS09MPN
	10 mm	17	19	60	17	14	16	4	M 14 x 1	blank	21KATS10MPX
	10 mm	17	19	60	17	14	16	4	M 14 x 1	nickel plated	21KATS10MPN
 <p>Plastic Hose Connection with Spring Guard</p>	4 x 6 mm	14		125	7	6	16		M 10 x 1	blank	21KAKK06MPX
	4 x 6 mm	14		125	7	6	16		M 10 x 1	nickel plated	21KAKK06MPN
	6 x 8 mm	14		130	7	6	16		M 10 x 1	blank	21KAKK08MPX
	6 x 8 mm	14		130	7	6	16		M 10 x 1	nickel plated	21KAKK08MPN



Plugs – without valve

Series 21KA

Brass/Steel

Low Pressure

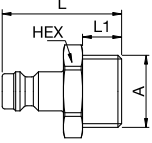
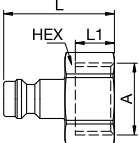
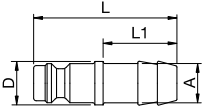
	Connection A	HEX mm	HEX1 mm	L mm	L1 mm	L2 mm	D mm	B mm	G mm	Version	Part Number
 <p>Male Thread</p>	G 1/8	14		25	7					blank	21SFAW10MXX
	G 1/8	14		25	7					nickel plated	21SFAW10MXN
	G 1/4	17		28	9					blank	21SFAW13MXX
	G 1/4	17		28	9					nickel plated	21SFAW13MXN
	G 3/8	19		28	9					blank	21SFAW17MXX
	G 3/8	19		28	9					nickel plated	21SFAW17MXN
	M 10 x 1	14		26	8					blank	21SFAD10MXX
	M 10 x 1	14		26	8					nickel plated	21SFAD10MXN
	M 12 x 1,5	17		28	10					blank	21SFAD12MXX
	M 12 x 1,5	17		28	10					nickel plated	21SFAD12MXN
 <p>Female Thread</p>	G 1/8	14		25	8					blank	21SFIW10MXX
	G 1/8	14		25	8					nickel plated	21SFIW10MXN
	G 1/4	17		25	9					blank	21SFIW13MXX
	G 1/4	17		25	9					nickel plated	21SFIW13MXN
	G 3/8	19		26	9					blank	21SFIW17MXX
	G 3/8	19		26	9					nickel plated	21SFIW17MXN
	M 10 x 1	14		26	9					blank	21SFIM10MXX
	M 10 x 1	14		26	9					nickel plated	21SFIM10MXN
	M 12 x 1,5	17		27	10					blank	21SFIM12MXX
	M 12 x 1,5	17		27	10					nickel plated	21SFIM12MXN
 <p>Hose Barb</p>	4 mm			32	17		9			blank	21SFTF04MXX
	4 mm			32	17		9			nickel plated	21SFTF04MXN
	5 mm			32	17		9			blank	21SFTF05MXX
	5 mm			32	17		9			nickel plated	21SFTF05MXN
	6 mm			32	17		9			blank	21SFTF06MXX
	6 mm			32	17		9			nickel plated	21SFTF06MXN
	8 mm			32	17		9			blank	21SFTF08MXX
	8 mm			32	17		9			nickel plated	21SFTF08MXN
	9 mm			33	17		10			blank	21SFTF09MXX
	9 mm			33	17		10			nickel plated	21SFTF09MXN
10 mm			33	17		12			blank	21SFTF10MXX	
10 mm			33	17		12			nickel plated	21SFTF10MXN	
6 mm Parker			36	20		16			blank	21SFTF06MXX	
6 mm Parker			36	20		16			nickel plated	21SFTF06MXN	



Plugs – without valve

Series 21KA

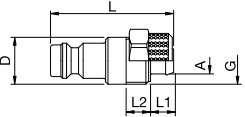
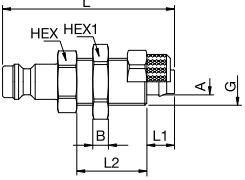
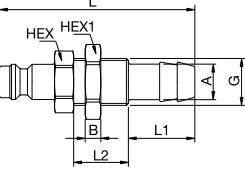
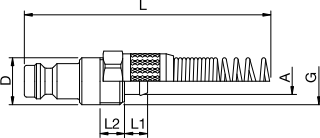
	Connection A	HEX mm	HEX1 mm	L mm	L1 mm	L2 mm	D mm	B mm	G mm	Version	Part Number
 <p>with Plastic Hose Connection</p>	4 x 6 mm			32	6	6	10		M 10 x 1	blank	21SFKO06MXX
	4 x 6 mm			32	6	6	10		M 10 x 1	nickel plated	21SFKO06MXN
	6 x 8 mm			32	6	6	12		M 12 x 1	blank	21SFKO08MXX
	6 x 8 mm			32	6	6	12		M 12 x 1	nickel plated	21SFKO08MXN
 <p>Panel Mount with Plastic Hose Connection</p>	4 x 6 mm	14	12	43	7	18		3	M 10 x 1	blank	21SFKS06MXX
	4 x 6 mm	14	12	43	7	18		3	M 10 x 1	nickel plated	21SFKS06MXN
	6 x 8 mm	14	17	44	7	18		4	M 12 x 1	blank	21SFKS08MXX
	6 x 8 mm	14	17	44	7	18		4	M 12 x 1	nickel plated	21SFKS08MXN
 <p>Panel Mount with Hose Barb</p>	4 mm	14	14	50	17	14		4	M 10 x 1	blank	21SFTS04MXX
	4 mm	14	14	50	17	14		4	M 10 x 1	nickel plated	21SFTS04MXN
	6 mm	14	17	50	17	14		4	M 12 x 1	blank	21SFTS06MXX
	6 mm	14	17	50	17	14		4	M 12 x 1	nickel plated	21SFTS06MXN
	8 mm	14	17	50	17	14		4	M 12 x 1	blank	21SFTS08MXX
	8 mm	14	17	50	17	14		4	M 12 x 1	nickel plated	21SFTS08MXN
 <p>Plastic Hose Connection with Spring Guard</p>	4 x 6 mm			115	6	6	10		M 10 x 1	blank	21SFKK06MXX
	4 x 6 mm			115	6	6	10		M 10 x 1	nickel plated	21SFKK06MXN
	6 x 8 mm			120	6	6	12		M 12 x 1	blank	21SFKK08MXX
	6 x 8 mm			120	6	6	12		M 12 x 1	nickel plated	21SFKK08MXN

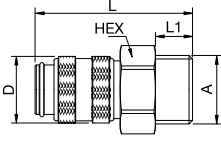
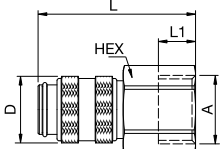
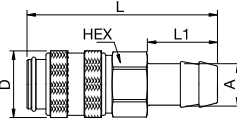
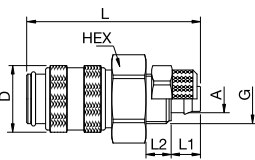

	Connection A	HEX mm	HEX1 mm	L mm	L1 mm	L2 mm	D mm	B mm	G mm	Version	Part Number
 <p>Male Thread</p>	G 1/8	14		36	7		16			blank	21KBAW10MPX
	G 1/8	14		36	7		16			nickel plated	21KBAW10MPN
	G 1/4	17		38	9		16			blank	21KBAW13MPX
	G 1/4	17		38	9		16			nickel plated	21KBAW13MPN
	G 3/8	19		38	9		16			blank	21KBAW17MPX
	G 3/8	19		38	9		16			nickel plated	21KBAW17MPN
	M 10 x 1	14		37	8		16			blank	21KBAD10MPX
	M 10 x 1	14		37	8		16			nickel plated	21KBAD10MPN
	M 12 x 1,5	17		39	10		16			blank	21KBAD12MPX
	M 12 x 1,5	17		39	10		16			nickel plated	21KBAD12MPN
	M 14 x 1,5	17		39	10		16			blank	21KBAD14MPX
	M 14 x 1,5	17		39	10		16			nickel plated	21KBAD14MPN
 <p>Female Thread</p>	G 1/8	14		36	9		16			blank	21KBIW10MPX
	G 1/8	14		36	9		16			nickel plated	21KBIW10MPN
	G 1/4	17		38	9		16			blank	21KBIW13MPX
	G 1/4	17		38	9		16			nickel plated	21KBIW13MPN
	G 3/8	19		38	9		16			blank	21KBIW17MPX
	G 3/8	19		38	9		16			nickel plated	21KBIW17MPN
	M 12 x 1,5	17		38	6		16			blank	21KBIM12MPX
	M 12 x 1,5	17		38	6		16			nickel plated	21KBIM12MPN
 <p>Hose Barb</p>	4 mm	14		46	17		16			blank	21KBTF04MPX
	4 mm	14		46	17		16			nickel plated	21KBTF04MPN
	5 mm	14		46	17		16			blank	21KBTF05MPX
	5 mm	14		46	17		16			nickel plated	21KBTF05MPN
	6 mm	14		46	17		16			blank	21KBTF06MPX
	6 mm	14		46	17		16			nickel plated	21KBTF06MPN
	8 mm	14		46	17		16			blank	21KBTF08MPX
	8 mm	14		46	17		16			nickel plated	21KBTF08MPN
	9 mm	14		46	17		16			blank	21KBTF09MPX
	9 mm	14		46	17		16			nickel plated	21KBTF09MPN
	10 mm	14		46	17		16			blank	21KBTF10MPX
	10 mm	14		46	17		16			nickel plated	21KBTF10MPN
 <p>with Plastic Hose Connection</p>	4 x 6 mm	14		42	7	6	16		M 10 x 1	blank	21KBKO06MPX
	4 x 6 mm	14		42	7	6	16		M 10 x 1	nickel plated	21KBKO06MPN
	6 x 8 mm	14		42	7	6	16		M 12 x 1	blank	21KBKO08MPX
	6 x 8 mm	14		42	7	6	16		M 12 x 1	nickel plated	21KBKO08MPN



Couplings – with valve

Series 21KB

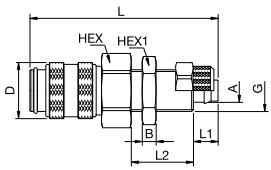
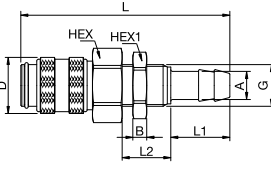
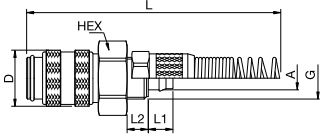
	Connection A	HEX mm	HEX1 mm	L mm	L1 mm	L2 mm	D mm	B mm	G mm	Version	Part Number
 <p>Panel Mount with Plastic Hose Connection</p>	4 x 6 mm	14	14	54	7	18	16	4	M 10 x 1	blank	21KBKS06MPX
	4 x 6 mm	14	14	54	7	18	16	4	M 10 x 1	nickel plated	21KBKS06MPN
	6 x 8 mm	17	17	54	7	18	16	4	M 12 x 1	blank	21KBKS08MPX
	6 x 8 mm	17	17	54	7	18	16	4	M 12 x 1	nickel plated	21KBKS08MPN
 <p>Panel Mount with Hose Barb</p>	4 mm	14	14	60	17	14	16	4	M 10 x 1	blank	21KBTS04MPX
	4 mm	14	14	60	17	14	16	4	M 10 x 1	nickel plated	21KBTS04MPN
	5 mm	17	17	60	17	14	16	4	M 12 x 1	blank	21KBTS05MPX
	5 mm	17	17	60	17	14	16	4	M 12 x 1	nickel plated	21KBTS05MPN
	6 mm	17	17	60	17	14	16	4	M 12 x 1	blank	21KBTS06MPX
	6 mm	17	17	60	17	14	16	4	M 12 x 1	nickel plated	21KBTS06MPN
	8 mm	17	17	60	17	14	16	4	M 12 x 1	blank	21KBTS08MPX
	8 mm	17	17	60	17	14	16	4	M 12 x 1	nickel plated	21KBTS08MPN
	9 mm	17	19	60	17	14	16	4	M 12 x 1	blank	21KBTS09MPX
9 mm	17	19	60	17	14	16	4	M 12 x 1	nickel plated	21KBTS09MPN	
 <p>Plastic Hose Connection with Spring Guard</p>	4 x 6 mm	14		125	7	6	16		M 10 x 1	blank	21KBKK06MPX
	4 x 6 mm	14		125	7	6	16		M 10 x 1	nickel plated	21KBKK06MPN
	M 12 x 1	14		130	7	6	16		M 10 x 1	blank	21KBKK08MPX
	M 12 x 1	14		130	7	6	16		M 10 x 1	nickel plated	21KBKK08MPN

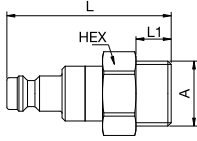
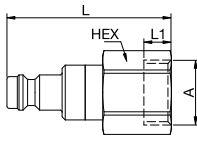
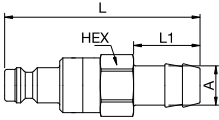
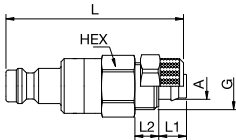

	Connection A	HEX mm	HEX1 mm	L mm	L1 mm	L2 mm	D mm	B mm	G mm	Version	Part Number	
 <p>Male Thread</p>	G 1/8	14		40	7					blank	21SBAW10MPX	
	G 1/8	14		40	7					nickel plated	21SBAW10MPN	
	G 1/4	17		42	9					blank	21SBAW13MPX	
	G 1/4	17		42	9					nickel plated	21SBAW13MPN	
	G 3/8	19		42	9					blank	21SBAW17MPX	
	G 3/8	19		42	9					nickel plated	21SBAW17MPN	
	M 10 x 1	14		41	8					blank	21SBAD10MPX	
	M 10 x 1	14		41	8					nickel plated	21SBAD10MPN	
	M 12 x 1,5	17		43	10					blank	21SBAD12MPX	
	M 12 x 1,5	17		43	10					nickel plated	21SBAD12MPN	
	M 14 x 1,5	17		43	10					blank	21SBAD14MPX	
	M 14 x 1,5	17		43	10					nickel plated	21SBAD14MPN	
 <p>Female Thread</p>	G 1/8	14		40	7					blank	21SBIW10MPX	
	G 1/8	14		40	7					nickel plated	21SBIW10MPN	
	G 1/4	17		42	7					blank	21SBIW13MPX	
	G 1/4	17		42	7					nickel plated	21SBIW13MPN	
	G 3/8	19		42	7					blank	21SBIW17MPX	
	G 3/8	19		42	7					nickel plated	21SBIW17MPN	
	M 12 x 1,5	17		42	7					blank	21SBIM12MPX	
	M 12 x 1,5	17		42	7					nickel plated	21SBIM12MPN	
	M 14 x 1,5	17		42	7					blank	21SBIM14MPX	
	M 14 x 1,5	17		42	7					nickel plated	21SBIM14MPN	
	 <p>Hose Barb</p>	4 mm	14		50	17					blank	21SBTF04MPX
		4 mm	14		50	17					nickel plated	21SBTF04MPN
5 mm		14		50	17					blank	21SBTF05MPX	
5 mm		14		50	17					nickel plated	21SBTF05MPN	
6 mm		14		50	17					blank	21SBTF06MPX	
6 mm		14		50	17					nickel plated	21SBTF06MPN	
8 mm		14		50	17					blank	21SBTF08MPX	
8 mm		14		50	17					nickel plated	21SBTF08MPN	
9 mm		14		50	17					blank	21SBTF09MPX	
9 mm		14		50	17					nickel plated	21SBTF09MPN	
10 mm		14		50	17					blank	21SBTF10MPX	
10 mm		14		50	17					nickel plated	21SBTF10MPN	
 <p>with Plastic Hose Connection</p>	4 x 6 mm	14		46	7	6			M 10 x 1	blank	21SBKO06MPX	
	4 x 6 mm	14		46	7	6			M 10 x 1	nickel plated	21SBKO06MPN	
	6 x 8 mm	14		46	7	6			M 12 x 1	blank	21SBKO08MPX	
	6 x 8 mm	14		46	7	6			M 12 x 1	nickel plated	21SBKO08MPN	



Plugs – with valve

Series 21KB

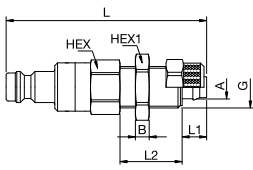
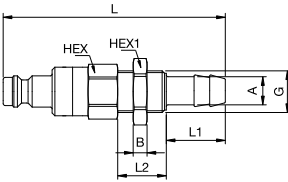
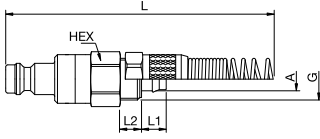
	Connection A	HEX mm	HEX1 mm	L mm	L1 mm	L2 mm	D mm	B mm	G mm	Version	Part Number
 <p>Panel Mount with Plastic Hose Connection</p>	4 x 6 mm	14	12	58	7	18		3	M 10 x 1	blank	21SBKS06MPX
	4 x 6 mm	14	12	58	7	18		3	M 10 x 1	nickel plated	21SBKS06MPN
	6 x 8 mm	17	17	58	7	18		4	M 12 x 1	blank	21SBKS08MPX
	6 x 8 mm	17	17	58	7	18		4	M 12 x 1	nickel plated	21SBKS08MPN
 <p>Panel Mount with Hose Barb</p>	4 mm	14	14	64	17	14		4	M 10 x 1	blank	21SBTS04MPX
	4 mm	14	14	64	17	14		4	M 10 x 1	nickel plated	21SBTS04MPN
	6 mm	14	17	64	17	14		4	M 12 x 1	blank	21SBTS06MPX
	6 mm	14	17	64	17	14		4	M 12 x 1	nickel plated	21SBTS06MPN
	8 mm	14	17	64	17	14		4	M 12 x 1	blank	21SBTS08MPX
	8 mm	14	17	64	17	14		4	M 12 x 1	nickel plated	21SBTS08MPN
	10 mm	14	19	64	17	14		4	M 14 x 1	blank	21SBTS10MPX
	10 mm	14	19	64	17	14		4	M 14 x 1	nickel plated	21SBTS10MPN
 <p>Plastic Hose Connection with Spring Guard</p>	4 x 6 mm	14		130	7	6			M 10 x 1	blank	21SBKK06MPX
	4 x 6 mm	14		130	7	6			M 10 x 1	nickel plated	21SBKK06MPN
	6 x 8 mm	14		135	7	6			M 12 x 1	blank	21SBKK08MPX
	6 x 8 mm	14		135	7	6			M 12 x 1	nickel plated	21SBKK08MPN

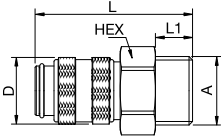
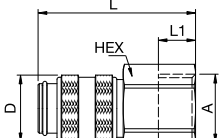
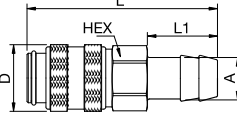
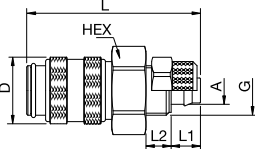
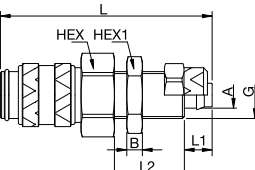

	Connection A	HEX mm	HEX1 mm	L mm	L1 mm	L2 mm	D mm	B mm	G mm	Version	Part Number
 <p>Male Thread</p>	G 1/8	14		36	7		16			blank	21KLAW10MPX
	G 1/8	14		36	7		16			nickel plated	21KLAW10MPN
	G 1/4	17		38	9		16			blank	21KLAW13MPX
	G 1/4	17		38	9		16			nickel plated	21KLAW13MPN
	G 3/8	19		38	9		16			blank	21KLAW17MPX
	G 3/8	19		38	9		16			nickel plated	21KLAW17MPN
 <p>Female Thread</p>	G 1/8	14		36	9		16			blank	21KLIW10MPX
	G 1/8	14		36	9		16			nickel plated	21KLIW10MPN
	G 1/4	17		38	9		16			blank	21KLIW13MPX
	G 1/4	17		38	9		16			nickel plated	21KLIW13MPN
	G 3/8	19		38	9		16			blank	21KLIW17MPX
	G 3/8	19		38	9		16			nickel plated	21KLIW17MPN
	M 14 x 1,5	17		38	6		16			blank	21KLIM14MPX
M 14 x 1,5	17		38	6		16			nickel plated	21KLIM14MPN	
 <p>Hose Barb</p>	4 mm	14		46	17		16			blank	21KLTF04MPX
	4 mm	14		46	17		16			nickel plated	21KLTF04MPN
	6 mm	14		46	17		16			blank	21KLTF06MPX
	6 mm	14		46	17		16			nickel plated	21KLTF06MPN
	8 mm	14		46	17		16			blank	21KLTF08MPX
	8 mm	14		46	17		16			nickel plated	21KLTF08MPN
	9 mm	14		46	17		16			blank	21KLTF09MPX
	9 mm	14		46	17		16			nickel plated	21KLTF09MPN
	10 mm	14		46	17		16			blank	21KLTF10MPX
	10 mm	14		46	17		16			nickel plated	21KLTF10MPN
 <p>with Plastic Hose Connection</p>	4 x 6 mm	14		42	7	6	16		M 10 x 1	blank	21KLKO06MPX
	4 x 6 mm	14		42	7	6	16		M 10 x 1	nickel plated	21KLKO06MPN
	6 x 8 mm	14		42	7	6	16		M 12 x 1	blank	21KLKO08MPX
	6 x 8 mm	14		42	7	6	16		M 12 x 1	nickel plated	21KLKO08MPN
 <p>Panel Mount with Plastic Hose Connection</p>	4 x 6 mm	14	14	54	7	18	16		M 10 x 1	blank	21KLKS06MPX
	4 x 6 mm	14	14	54	7	18	16		M 10 x 1	nickel plated	21KLKS06MPN
	6 x 8 mm	17	17	54	7	18	16		M 12 x 1	blank	21KLKS08MPX
	6 x 8 mm	17	17	54	7	18	16		M 12 x 1	nickel plated	21KLKS08MPN

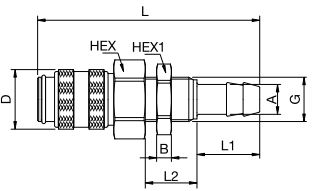
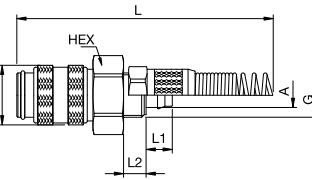

Couplings – flat sealing
Series 21KL

	Connection A	HEX mm	HEX1 mm	L mm	L1 mm	L2 mm	D mm	B mm	G mm	Version	Part Number
 <p>Panel Mount with Hose Barb</p>	4 mm	14	14	60	17	14	16	4	M 10 x 1	blank	21KLTS04MPX
	4 mm	14	14	60	17	14	16	4	M 10 x 1	nickel plated	21KLTS04MPN
	5 mm	17	17	60	17	14	16	4	M 12 x 1	blank	21KLTS05MPX
	5 mm	17	17	60	17	14	16	4	M 12 x 1	nickel plated	21KLTS05MPN
	6 mm	17	17	60	17	14	16	4	M 12 x 1	blank	21KLTS06MPX
	8 mm	17	17	60	17	14	16	4	M 12 x 1	blank	21KLTS08MPX
	8 mm	17	17	60	17	14	16	4	M 12 x 1	nickel plated	21KLTS08MPN
 <p>Plastic Hose Connection with Spring Guard</p>	4 x 6 mm	14		125	7	6	16		M 10 x 1	blank	21KLKK06MPX
	4 x 6 mm	14		125	7	6	16		M 10 x 1	nickel plated	21KLKK06MPN
	6 x 8 mm	14		130	7	6	16		M 10 x 1	blank	21KLKK08MPX
	6 x 8 mm	14		130	7	6	16		M 10 x 1	nickel plated	21KLKK08MPN

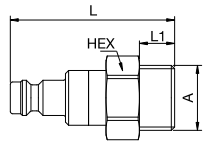
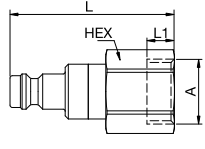
Plugs – flat sealing
Series 21KL

	Connection A	HEX mm	HEX1 mm	L mm	L1 mm	L2 mm	D mm	B mm	G mm	Version	Part Number
 <p>Male Thread</p>	G 1/8	14		40	7					blank	21SLAW10MPX
	G 1/8	14		40	7					nickel plated	21SLAW10MPN
	G 1/4	17		42	9					blank	21SLAW13MPX
	G 1/4	17		42	9					nickel plated	21SLAW13MPN
	M 12 x 1,5	17		43	10					blank	21SLAD12MPX
	M 12 x 1,5	17		43	10					nickel plated	21SLAD12MPN
 <p>Female Thread</p>	G 1/8	14		40	7					blank	21SLIW10MPX
	G 1/8	14		40	7					nickel plated	21SLIW10MPN
	G 1/4	17		42	7					blank	21SLIW13MPX
	G 1/4	17		42	7					nickel plated	21SLIW13MPN
	G 3/8	19		42	7					blank	21SLIW17MPX
	G 3/8	19		42	7					nickel plated	21SLIW17MPN

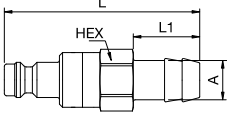
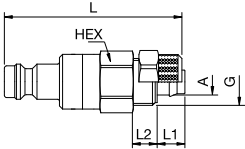
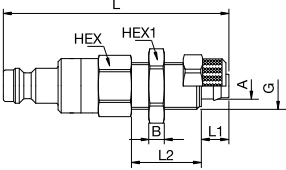
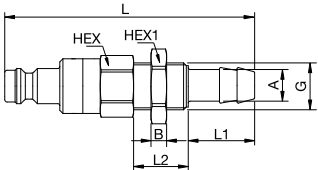
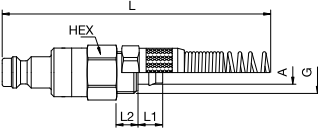

	Connection A	HEX mm	HEX1 mm	L mm	L1 mm	L2 mm	D mm	B mm	G mm	Version	Part Number
 <p>Hose Barb</p>	4 mm	14		50	17					blank	21SLTF04MPX
	4 mm	14		50	17					nickel plated	21SLTF04MPN
	6 mm	14		50	17					blank	21SLTF06MPX
	6 mm	14		50	17					nickel plated	21SLTF06MPN
	8 mm	14		50	17					blank	21SLTF08MPX
	8 mm	14		50	17					nickel plated	21SLTF08MPN
	9 mm	14		50	17					blank	21SLTF09MPX
	9 mm	14		50	17					nickel plated	21SLTF09MPN
	10 mm	14		50	17					blank	21SLTF10MPX
	10 mm	14		50	17					nickel plated	21SLTF10MPN
 <p>with Plastic Hose Connection</p>	4 x 6 mm	14		46	7	6			M 10 x 1	blank	21SLKO06MPX
	4 x 6 mm	14		46	7	6			M 10 x 1	nickel plated	21SLKO06MPN
	6 x 8 mm	14		46	7	6			M 12 x 1	blank	21SLKO08MPX
	6 x 8 mm	14		46	7	6			M 12 x 1	nickel plated	21SLKO08MPN
 <p>Panel Mount with Plastic Hose Connection</p>	6 x 8 mm	14	17	58	7	18		4	M 12 x 1	blank	21SLKS08MPX
	6 x 8 mm	14	17	58	7	18		4	M 12 x 1	nickel plated	21SLKS08MPN
 <p>Panel Mount with Hose Barb</p>	5 mm	14	14	64	17	14		4	M 12 x 1	blank	21SLTS05MPX
	5 mm	14	14	64	17	14		4	M 12 x 1	nickel plated	21SLTS05MPN
	6 mm	14	17	64	17	14		4	M 12 x 1	blank	21SLTS06MPX
	6 mm	14	17	64	17	14		4	M 12 x 1	nickel plated	21SLTS06MPN
	10 mm	14	19	64	17	14		4	M 14 x 1	blank	21SLTS10MPX
	10 mm	14	19	64	17	14		4	M 14 x 1	nickel plated	21SLTS10MPN
 <p>Plastic Hose Connection with Spring Guard</p>	4 x 6 mm	14		130	7	6			M 10 x 1	blank	21SLKK06MPX
	4 x 6 mm	14		130	7	6			M 10 x 1	nickel plated	21SLKK06MPN
	6 x 8 mm	14		135	7	6			M 12 x 1	blank	21SLKK08MPX
	6 x 8 mm	14		135	7	6			M 12 x 1	nickel plated	21SLKK08MPN

Nominal Diameter

5,5 = 24 mm²

Tema Series

1100

Robust design with small dimensions. Series 1100 is used mainly for applications in the area of compressed air and liquids. Optimally suited to smaller pneumatic systems and to compressed air tools with a consumption of up to 900 litres per minute. Coupling systems with two-hand operation, i.e. both hands are required when connect/disconnect.

Series 1100 with additional end connections available on request.

Dust Protections  (P. 250)
for Coupling Part.-No. 2315-QC
for Plug Part.-No. 125-QC

Working Temperature*
-20°C up to +100°C (NBR)
depending on the medium.

* For temperatures below -20°C and over +100°C and depending on the medium, other seal variants (FKM, EPDM, FFKM) are available.

**Working Pressure****

30 bar

** maximum static working pressure with design factor 4 to 1.

20 bar

Material

Coupling: Brass nickel plated and chrome plated

Plug: Steel zinc plated

Seals: NBR

Coupling: Brass nickel plated and chrome plated

Plug: Brass nickel plated and chrome plated

Seals: NBR

Interchangeability (KA only)

- Tema Design

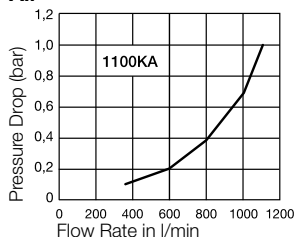
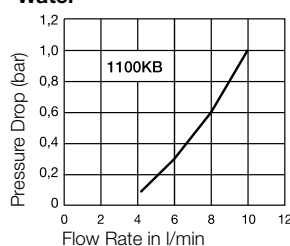
Flow diagrams**Air****Water**



Couplings – with valve

Series 1100KA

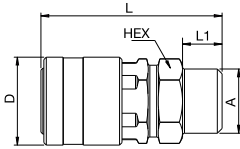
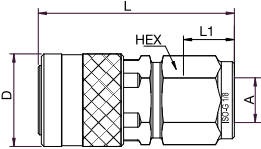
	Connection A	HEX mm	L mm	L1 mm	D mm	Part Number
 <p>Male Thread</p>	G 1/4	15	37	8	18	1100KAAW13MPC
 <p>Female Thread</p>	G 1/8	15	38	8	18	1100KAIW10MPC



Plugs – without valve

Series 1100KA

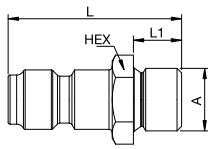
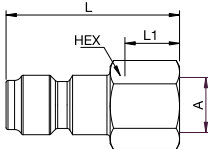
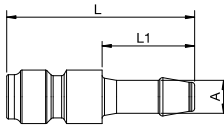
	Connection A	HEX mm	L mm	L1 mm	D mm	Part Number
 <p>Male Thread</p>	G 1/8	12	27	7,5		1100SFAW10SXZ
 <p>Female Thread</p>	G 1/8	12	27	7		1100SFIW10SXZ
 <p>Hose Barb</p>	5 mm		33	16		1100SFTF05SXZ
	6 mm		33	16		1100SFTF06SXZ



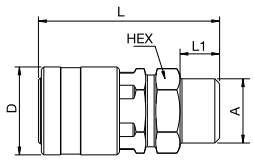
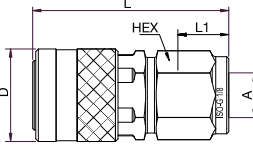

Couplings – with valve Series 1100KB

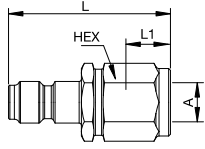
	Connection A	HEX mm	L mm	L1 mm	D mm	Part Number
 <p>Male Thread</p>	G 1/4	15	38	8	18	1100KBAW13MPC
 <p>Female Thread</p>	G 1/8	15	37	8	18	1100KBIW10MPC

Plugs – with valve Series 1100KB

	Connection A	HEX mm	L mm	L1 mm	D mm	Part Number
 <p>Female Thread</p>	G 1/8	15	36	8		1100SBIW10MPC

Cross-Reference-List

Connection	Thread	Rectus Part Number old	Tema Part Number old	Part Number new	Page
 Couplings – with valve					
Male Thread	G 1/4	-	1100 A	1100KAAW13MPC	39
Female Thread	G 1/8	-	1100	1100KAIW10MPC	39
 Plugs – without valve					
Male Thread	G 1/8	-	11110-QC	1100SFAW10SXZ	39
Female Thread	G 1/8	-	11410	1100SFIW10SXZ	39
Hose Barb	5 mm	-	11005-QC	1100SFTF05SXZ	39
	6 mm	-	11006-QC	1100SFTF06SXZ	39
 Couplings – with valve					
Male Thread	G 1/4	-	1100 NA	1100KBAW13MPC	40
Female Thread	G 1/8	-	1100 N	1100KBIW10MPC	40
 Plugs – with valve					
Female Thread	G 1/8	-	11410 MN	1100SBIW10MPC	40

Nominal Diameter

5,5 = 25 mm²

Rectus Series

14



Robust brass coupling with numerous connection options. Preferred application is the compressed air technology. Also particularly suited to use with water due to the brass valve.

Coupling system with single-hand operation. Plug design optimised through greater insert depth.

Series 14 in brass material with nickel plating and with additional end connections available on request.

Working Temperature*

-20°C up to +100°C (NBR) depending on the medium.

* For temperatures below -20°C and over +100°C and depending on the medium, other seal variants (FKM, EPDM, FFKM) are available.

Other designs in series 14

The following other designs can be found from page:

► Safety Self-Venting P. 222

**Working Pressure****

35 bar

** maximum static working pressure with design factor 4 to 1.

Material

Coupling: Brass

Plug: Steel nickel plated or Brass

Seals: NBR

Technical Description

Connecting Force 0 bar: 30 N

Connecting Force 6 bar: 70 N

Vacuum Coupling: 96%

Vacuum connected: 96%

Interchangeability (KA only)

- Rectus 22
- ARO 210
- Cejn 300
- Orion 44510
- JWL 552 + JWL 532
- various Swiss Products

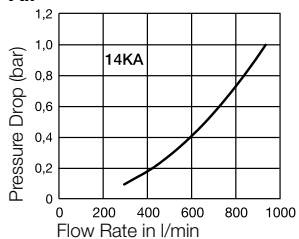
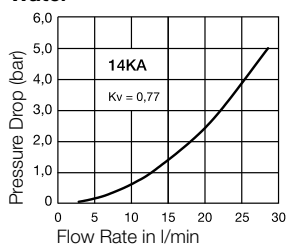
Flow diagrams**Air****Water**



Couplings – with valve

Series 14KA

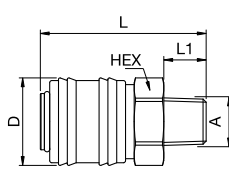
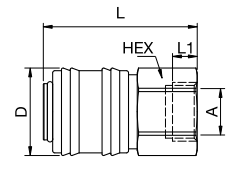
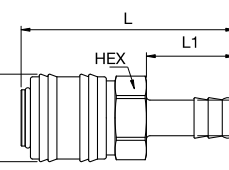
	Connection A	HEX mm	L mm	L1 mm	D mm	Version	Part Number
 <p>Male Thread</p>	G 1/4	22	43	9	25		14KAAW13MPX
	G 3/8	22	43	9	25		14KAAW17MPX
	G 1/2	22	46	12	25		14KAAW21MPX
 <p>Female Thread</p>	G 1/4	22	43	9	25		14KAIW13MPX
	G 3/8	22	43	9	25		14KAIW17MPX
	G 1/2	24	46	12	25		14KAIW21MPX
 <p>Hose Barb</p>	6 mm	21	60	25	25		14KATF06MPX
	8 mm	21	60	25	25		14KATF08MPX
	9 mm	21	60	25	25		14KATF09MPX
	10 mm	21	60	25	25		14KATF10MPX
	13 mm	21	60	25	25		14KATF13MPX



Plugs – without valve

Series 22SF

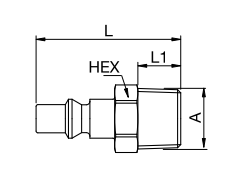
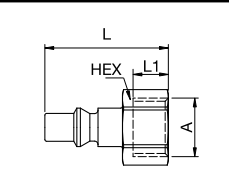
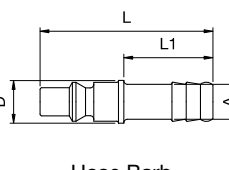
	Connection A	HEX mm	L mm	L1 mm	D mm	Version	Part Number
 <p>Male Thread</p>	R 1/8	12	35	9		Steel	22SFAK10SXN
	R 1/4	14	41	12		Steel	22SFAK13SXN
	R 1/4	14	41	12		Brass	22SFAK13MXX
	G 1/4	14	41	12		Brass	22SFAW13MXX
	R 3/8	17	41	12		Steel	22SFAK17SXN
	G 3/8	17	41	12		Brass	22SFAW17MXX
	R 1/2	22	46	17		Steel	22SFAK21SXN
	G 1/2	22	46	17		Brass	22SFAW21MXX
 <p>Female Thread</p>	G 1/4	17	35	9		Steel	22SFIW13SXN
	G 1/4	17	35	9		Brass	22SFIW13MXX
	G 3/8	19	35	10		Steel	22SFIW17SXN
	G 1/2	24	35	12		Steel	22SFIW21SXN
 <p>Hose Barb</p>	6 mm		49	25	12	Steel	22SFTF06SXN
	6 mm		49	25	12	Brass	22SFTF06MXX
	8 mm		49	25	12	Steel	22SFTF08SXN
	10 mm		49	25	12	Steel	22SFTF10SXN
	10 mm		49	25	12	Brass	22SFTF10MXX
	13 mm		49	25	15	Steel	22SFTF13SXN

Nominal Diameter

5,5 = 25 mm²

Rectus Series

18

Robust industrial coupling according to ISO 6150 C. Coupling system with single-hand operation. High Flow valve for optimum flow and low pressure drop. The steel sleeve counters oscillating forces. System has limited use for liquids (steel sleeve/zinc die cast valve). The high insertion depth is guaranteed by an optimised plug guide.

Series 18 with additional end connections available on request.

Dust Protections  (P. 250)
for Coupling Part.-No. SK23S

Working Temperature*
-20°C up to +100°C (NBR)
depending on the medium.

* For temperatures below -20°C and over +100°C and depending on the medium, other seal variants (FKM, EPDM, FFKM) are available.

**Working Pressure****

35 bar

** maximum static working pressure with design factor 4 to 1.

Material

Coupling: Brass / Steel nickel plated
Plug: Steel nickel plated
Seals: NBR

Technical Description

Connecting Force 0 bar: 40 N
Connecting Force 6 bar: 110 N

Vacuum Coupling: 96%
Vacuum connected: 96%

Interchangeability (KA only)

- Cejn 291
- Oetiker
- ISO 6150 C

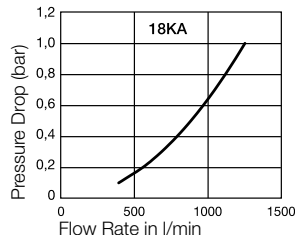
Flow diagrams**Air**



Couplings – with valve

Series 18KA

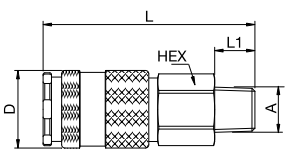
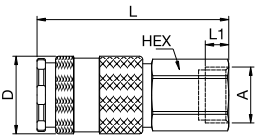
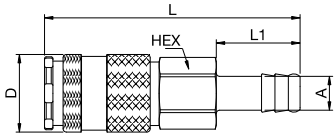
	Connection A	HEX mm	L mm	L1 mm	D mm	Part Number
 <p>Male Thread</p>	R 1/4	19	63	12	23	18KAAK13MPN
	R 3/8	19	62	12	23	18KAAK17MPN
	R 1/2	22	63	17	23	18KAAK21MPN
 <p>Female Thread</p>	G 1/4	19	58	9	23	18KAIW13MPN
	G 3/8	19	57	9	23	18KAIW17MPN
	G 1/2	24	60	12	23	18KAIW21MPN
 <p>Hose Barb</p>	6 mm	19	76	25	23	18KATF06MPN
	8 mm	19	76	25	23	18KATF08MPN
	10 mm	19	76	25	23	18KATF10MPN
	13 mm	19	76	25	23	18KATF13MPN



Plugs – without valve

Series 18KA

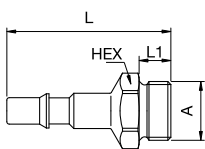
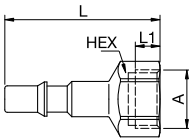
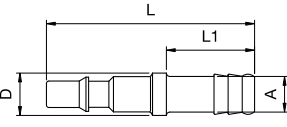
	Connection A	HEX mm	L mm	L1 mm	D mm	Part Number
 <p>Male Thread</p>	G 1/4	17	41	9		18SFAW13SXN
	G 3/8	19	41	9		18SFAW17SXN
 <p>Female Thread</p>	G 1/4	17	43	9		18SFIW13SXN
	G 3/8	19	44	9		18SFIW17SXN
 <p>Hose Barb</p>	6 mm		59	25	12	18SFTF06SXN
	8 mm		59	25	12	18SFTF08SXN
	10 mm		59	25	12	18SFTF10SXN

Nominal Diameter

5,5 = 25 mm²

Rectus Series

19

English industrial profile.
Coupling system with single-hand operation. High Flow valve for optimum flow and low pressure drop. Robust coupling in slim design mainly for pneumatic applications. The steel sleeve counters oscillating forces. The high insertion depth is guaranteed by an optimised plug guide.

Series 19 with additional end connections available on request.

Dust Protections  (P. 250)
for Coupling Part.-No. SK23S

Working Temperature*
-20°C up to +100°C (NBR)
depending on the medium.

* For temperatures below -20°C and over +100°C and depending on the medium, other seal variants (FKM, EPDM, FFKM) are available.

**Working Pressure****

35 bar

** maximum static working pressure with design factor 4 to 1.

Material

Coupling: Brass / Steel nickel plated

Plug: Steel nickel plated

Seals: NBR

Technical Description

Connecting Force 0 bar: 70 N

Connecting Force 6 bar: 180 N

Vacuum Coupling: 87%

Vacuum connected: 87%

Interchangeability (KA only)

- PCL 60 (UK)

Flow diagrams

Air

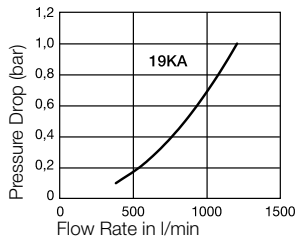



Couplings – with valve

Series 19KA

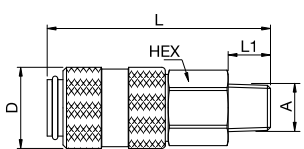
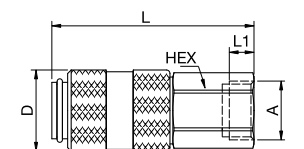
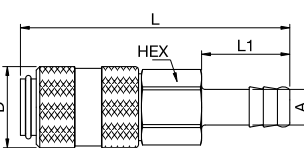
	Connection A	HEX mm	L mm	L1 mm	D mm	Part Number
 <p>Male Thread</p>	R 1/4	19	63	12	23	19KAAK13MPN
	R 3/8	19	62	12	23	19KAAK17MPN
	R 1/2	22	68	17	23	19KAAK21MPN
 <p>Female Thread</p>	G 1/4	19	58	9	23	19KAIW13MPN
	G 3/8	19	58	9	23	19KAIW17MPN
	G 1/2	24	60	12	23	19KAIW21MPN
 <p>Hose Barb</p>	6 mm	19	76	25	23	19KATF06MPN
	8 mm	19	76	25	23	19KATF08MPN
	10 mm	19	76	25	23	19KATF10MPN
	13 mm	19	76	25	23	19KATF13MPN



Plugs – without valve

Series 19KA

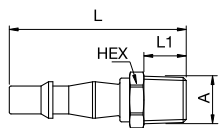
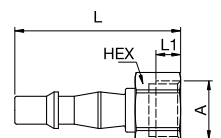
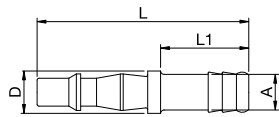
	Connection A	HEX mm	L mm	L1 mm	D mm	Part Number
 <p>Male Thread</p>	R 1/4	14	50	12		19SFAK13SXN
 <p>Female Thread</p>	G 1/4	17	46	9		19SFIW13SXN
 <p>Hose Barb</p>	6 mm		60	25	12	19SFTF06SXN
	8 mm		60	25	12	19SFTF08SXN
	10 mm		60	25	12	19SFTF10SXN

Nominal Diameter

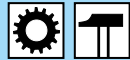
5,5 = 25 mm²

Rectus Series

22

Coupling system with single-hand operation. High Flow valve for optimum flow and low pressure drop. Specially suited to use with gaseous media in industry. The steel sleeve counters oscillating forces. The high insertion depth is guaranteed by an optimised plug guide.

Series 22 with additional end connections available on request.

Dust Protections  (P. 250)
for Coupling Part.-No. SK23S

Working Temperature*
-20°C up to +100°C (NBR)
depending on the medium.

* For temperatures below -20°C and over +100°C and depending on the medium, other seal variants (FKM, EPDM, FFKM) are available.

**Working Pressure****

35 bar

** maximum static working pressure with design factor 4 to 1.

Material

Coupling: Brass / Steel nickel plated

Plug: Steel nickel plated or Brass

Seals: NBR

Technical Description

Connecting Force 0 bar: 40 N

Connecting Force 6 bar: 120 N

Interchangeability (KA only)

- Rectus 14
- ARO 210
- Parker 50
- Cejn 300
- Orion 44510
- JWL 522 + JWL 532
- various Swiss Products

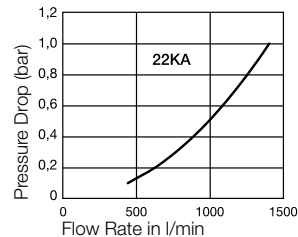
Flow diagrams**Air**



Couplings – with valve

Series 22KA

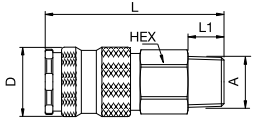
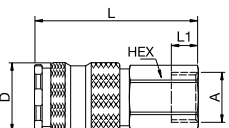
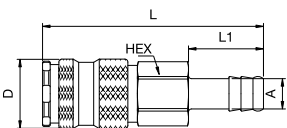
	Connection A	HEX mm	L mm	L1 mm	D mm	Version	Part Number
 <p>Male Thread</p>	R 1/4	19	61	12	23		22KAAK13MPN
	R 3/8	19	60	12	23		22KAAK17MPN
	R 1/2	22	61	17	23		22KAAK21MPN
 <p>Female Thread</p>	G 1/4	19	56	9	23		22KAIW13MPN
	G 3/8	19	55	9	23		22KAIW17MPN
	G 1/2	24	58	9	23		22KAIW21MPN
 <p>Hose Barb</p>	6 mm	19	74	25	23		22KATF06MPN
	8 mm	19	74	25	23		22KATF08MPN
	9 mm	19	74	25	23		22KATF09MPN
	10 mm	19	74	25	23		22KATF10MPN
	13 mm	19	74	25	23		22KATF13MPN



Plugs – without valve

Series 22SF

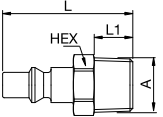
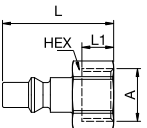
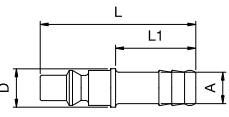
	Connection A	HEX mm	L mm	L1 mm	D mm	Version	Part Number
 <p>Male Thread</p>	R 1/8	12	35	9		Steel	22SFAK10SXN
	R 1/4	14	41	12		Steel	22SFAK13SXN
	R 1/4	14	41	12		Brass	22SFAK13MXX
	G 1/4	14	41	12		Brass	22SFAW13MXX
	R 3/8	17	41	12		Steel	22SFAK17SXN
	G 3/8	17	41	12		Brass	22SFAW17MXX
	R 1/2	22	46	17		Steel	22SFAK21SXN
	G 1/2	22	46	17		Brass	22SFAW21MXX
 <p>Female Thread</p>	G 1/4	17	35	9		Steel	22SFIW13SXN
	G 1/4	17	35	9		Brass	22SFIW13MXX
	G 3/8	19	35	10		Steel	22SFIW17SXN
	G 1/2	24	35	12		Steel	22SFIW21SXN
 <p>Hose Barb</p>	6 mm		49	25	12	Steel	22SFTF06SXN
	6 mm		49	25	12	Brass	22SFTF06MXX
	8 mm		49	25	12	Steel	22SFTF08SXN
	10 mm		49	25	12	Steel	22SFTF10SXN
	10 mm		49	25	12	Brass	22SFTF10MXX
	13 mm		49	25	15	Steel	22SFTF13SXN

Nominal Diameter

5,5 = 25 mm²

Rectus Tema Series

1400energy
saver**Other designs in series 1400**

The following other designs can be found from page:

- Safety Self-Venting P. 224

Interchangeability (KA only)

- Rectus 24
- Industr. Interchange 1/4"
- US-MIL-SPEC-C-4109
- ISO 6150 B
- Cejn 310
- Hansen 3000
- Faster
- Gromelle 600
- JWL 521 + JWL 531

RectusTema premium industrial coupling 1/4" according to ISO 6150 B. Suitable for compressed air applications with greater than average air consumption. Coupling system with single-hand operation. Ultra High Flow valve for optimum flow and low pressure drop.

Series 1400 with additional end connections available on request.

Dust Protections (P. 250)
for Coupling Part.-No. SK23S

Working Temperature*

-20°C up to +100°C (NBR)
depending on the medium.

* For temperatures below -20°C and over +100°C and depending on the medium, other seal variants (FKM, EPDM, FFKM) are available.

**Working Pressure****

35 bar

** maximum static working pressure with design factor 4 to 1.

Material

Coupling: Brass nickel plated,
Steel QPQ treated

Plug: Steel nickel plated or Brass

Seals: NBR

Technical Description

Connecting Force 0 bar: 35 N

Connecting Force 6 bar: 75 N

Vacuum Coupling: 96%

Vacuum connected: 96%

Flow diagrams

Air

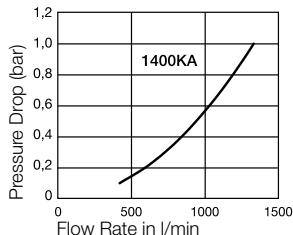



Couplings – with valve

Series 1400KA

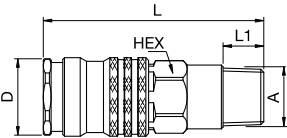
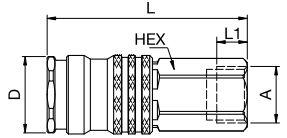
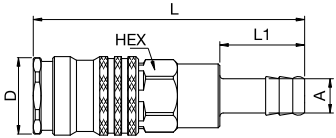
	Connection A	HEX mm	L mm	L1 mm	D mm	Version	Part Number
 <p>Male Thread</p>	R 1/4	19	65	12	23		1400KAAK13SPN
	R 3/8	19	65	12	23		1400KAAK17SPN
	R 1/2	22	59,5	17	23		1400KAAK21SPN
 <p>Female Thread</p>	G 1/4	19	59	9	23		1400KAIW13SPN
	G 3/8	19	59	9	23		1400KAIW17SPN
	G 1/2	24	62	12	23		1400KAIW21SPN
 <p>Hose Barb</p>	6 mm	19	80	25	23		1400KATF06SPN
	8 mm	19	80	25	23		1400KATF08SPN
	10 mm	19	80	25	23		1400KATF10SPN
	13 mm	19	80	25	23		1400KATF13SPN



Plugs – without valve

Series 23SF

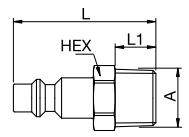
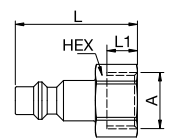
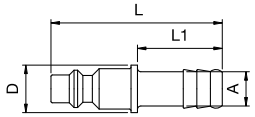
	Connection A	HEX mm	L mm	L1 mm	D mm	Version	Part Number
 <p>Male Thread</p>	R 1/8	13	39	9		Steel	23SFAK10SXN
	R 1/4	14	42	12		Steel	23SFAK13SXN
	G 1/4	14	42	12		Brass	23SFAW13MXX
	R 3/8	17	42	12		Steel	23SFAK17SXN
	G 3/8	17	42	12		Brass	23SFAW17MXX
 <p>Female Thread</p>	R 1/2	22	48	17		Steel	23SFAK21SXN
	G 1/8	14	36	9		Steel	23SFIW10SXN
	G 1/4	17	36	9		Steel	23SFIW13SXN
	G 3/8	19	36	9		Steel	23SFIW17SXN
 <p>Hose Barb</p>	G 1/2	24	39	12		Steel	23SFIW21SXN
	6 mm		51	25	14	Steel	23SFTF06SXN
	6 mm		51	25	14	Brass	23SFTF06MXX
	8 mm		51	25	14	Steel	23SFTF08SXN
	9 mm		51	25	14	Steel	23SFTF09SXN
	9 mm		51	25	14	Brass	23SFTF09MXX
10 mm		51	25	14	Steel	23SFTF10SXN	
13 mm		51	25	14	Steel	23SFTF13SXN	

Nominal Diameter

5,5 = 25 mm²

Rectus Series

24**Other designs in series 24**

The following other designs can be found from page:

- Safety Self-Venting P. 226

Interchangeability (KA only)

- Rectus 1400
- Industr. Interchange 1/4"
- US-MIL-SPEC-C-4109
- ISO 6150 B
- Cejn 310
- Hansen 3000
- Faster
- Gromelle 600
- Parker 20 1/4" + 30 1/4"
- JWL 521 + JWL 531

1/4" Industrial brass coupling according to ISO 6150 B and US MIL-SPEC 4109.

Coupling system with single-hand operation, which stands out for its solid brass design and corresponding sleeve design. Hardened steel plug counters vibrations and effects of external forces.

Series 24 in brass material with nickel plating and with additional end connections available on request.

Working Temperature*

-20°C up to +100°C (NBR)
depending on the medium.

* For temperatures below -20°C and over +100°C and depending on the medium, other seal variants (FKM, EPDM, FFKM) are available.

**Working Pressure****

35 bar

** maximum static working pressure with design factor 4 to 1.

Material

Coupling: Brass

Plug: Steel nickel plated or Brass

Seals: NBR

Technical Description

Connecting Force 0 bar: 40 N

Connecting Force 6 bar: 80 N

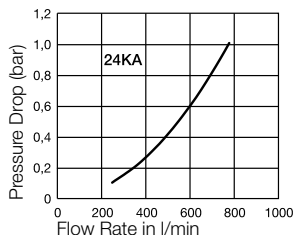
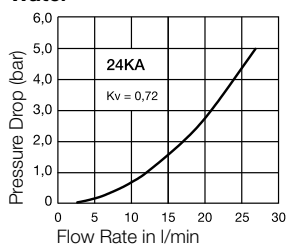
Flow diagrams**Air****Water**



Couplings – with valve

Series 24KA

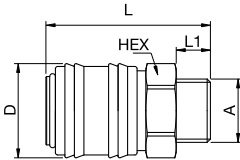
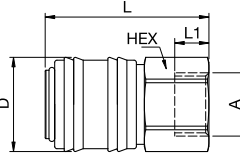
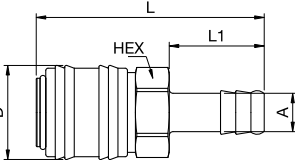
	Connection A	HEX mm	L mm	L1 mm	D mm	Version	Part Number
 <p>Male Thread</p>	G 1/4	22	43	9	25		24KAAW13MPX
	G 3/8	22	43	9	25		24KAAW17MPX
	G 1/2	22	46	12	25		24KAAW21MPX
 <p>Female Thread</p>	G 1/4	22	43	11	25		24KAIW13MPX
	G 3/8	22	43	9	25		24KAIW17MPX
	G 1/2	22	46	12	25		24KAIW21MPX
 <p>Hose Barb</p>	6 mm	21	60	25	25		24KATF06MPX
	8 mm	21	60	25	25		24KATF08MPX
	9 mm	21	60	25	25		24KATF09MPX
	10 mm	21	60	25	25		24KATF10MPX
	13 mm	21	60	25	25		24KATF13MPX



Plugs - without valve

Series 23SF

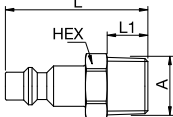
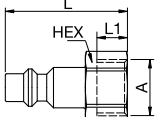
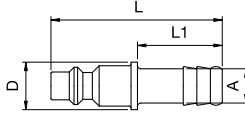
	Connection A	HEX mm	L mm	L1 mm	D mm	Version	Part Number
 <p>Male Thread</p>	R 1/8	13	39	9		Steel	23SFAK10SXN
	R 1/4	14	42	12		Steel	23SFAK13SXN
	G 1/4	14	42	12		Brass	23SFAW13MXX
	R 3/8	17	42	12		Steel	23SFAK17SXN
	G 3/8	17	42	12		Brass	23SFAW17MXX
	R 1/2	22	48	17		Steel	23SFAK21SXN
 <p>Female Thread</p>	G 1/8	14	36	9		Steel	23SFIW10SXN
	G 1/4	17	36	9		Steel	23SFIW13SXN
	G 3/8	19	36	9		Steel	23SFIW17SXN
	G 1/2	24	39	12		Steel	23SFIW21SXN
 <p>Hose Barb</p>	6 mm		51	25	14	Steel	23SFTF06SXN
	6 mm		51	25	14	Brass	23SFTF06MXX
	8 mm		51	25	14	Steel	23SFTF08SXN
	9 mm		51	25	14	Steel	23SFTF09SXN
	9 mm		51	25	14	Brass	23SFTF09MXX
	10 mm		51	25	14	Steel	23SFTF10SXN
	13 mm		51	25	14	Steel	23SFTF13SXN



Coupling system with German industrial profile. Coupling system with single-hand operation. High Flow valve for optimum flow and low pressure drop. Robust coupling in slim design mainly for pneumatic applications. The steel sleeve counters oscillating forces. The high insertion depth is guaranteed by an optimised plug guide.

Series 52 with additional end connections available on request.

Dust Protections  (P. 250) for Coupling Part.-No. SK23S for Plug Part.-No. SK12S

Working Temperature*
-20°C up to +100°C (NBR) depending on the medium.

* For temperatures below -20°C and over +100°C and depending on the medium, other seal variants (FKM, EPDM, FFKM) are available.



Working Pressure**

50 bar
** maximum static working pressure with design factor 4 to 1.

50 bar

Material

Coupling: Brass / Steel nickel plated
Plug: Steel nickel plated
Seal: NBR

Coupling: Brass / Steel nickel plated
Plug: Brass / Steel nickel plated
Seals: NBR

Technical Description

Connecting Force 0 bar: 60 N
Connecting Force 6 bar: 120 N

Connecting Force 0 bar: 65 N
Connecting Force 6 bar: 135 N

Interchangeability (KA only)

- Walther LP006

Flow diagrams

Air

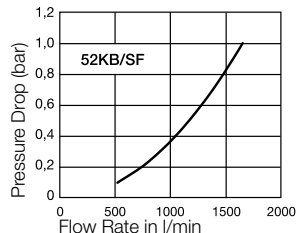

Air

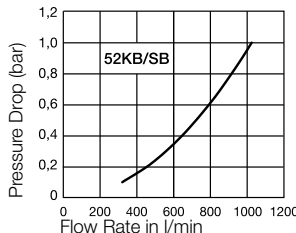

Water

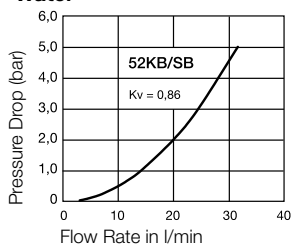

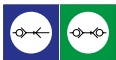

Couplings – with valve

Series 52KB

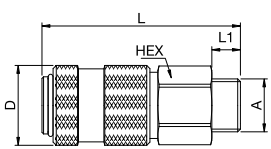
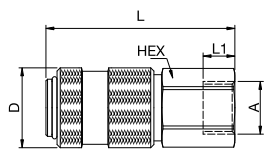
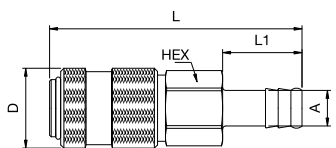
	Connection A	HEX mm	L mm	L1 mm	D mm	Part Number
 <p>Male Thread</p>	G 1/4	22	62	9	25	52KBAW13SPN
	G 3/8	22	62	9	25	52KBAW17SPN
	G 1/2	22	65	12	25	52KBAW21SPN
 <p>Female Thread</p>	G 1/4	22	62	10	25	52KBIW13SPN
	G 3/8	22	60	10	25	52KBIW17SPN
	G 1/2	22	65	13	25	52KBIW21SPN
 <p>Hose Barb</p>	9 mm	21	80	25	25	52KBTf09SPN



Plugs – without valve

Series 52SF

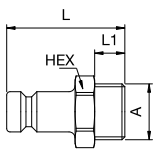
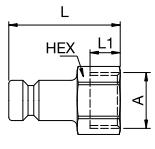
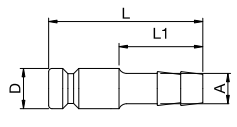
	Connection A	HEX mm	L mm	L1 mm	D mm	Part Number
 <p>Male Thread</p>	G 1/4	17	35	9		52SFAW13SXN
	G 3/8	19	35	9		52SFAW17SXN
 <p>Female Thread</p>	G 1/4	17	33	9		52SFIW13SXN
	G 3/8	19	33	9		52SFIW17SXN
	G 1/2	24	36	12		52SFIW21SXN
 <p>Hose Barb</p>	6 mm		46	25	12	52SFTF06SXN
	9 mm		46	25	12	52SFTF09SXN
	13 mm		53	30	12	52SFTF13SXN



Plugs – with valve

Series 52SB

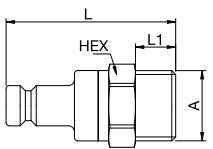
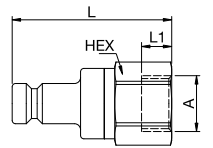
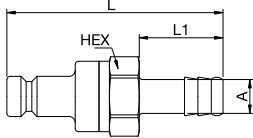
	Connection A	HEX mm	L mm	L1 mm	D mm	Part Number	
 <p>Male Thread</p>	G 1/4	22	48	9		52SBAW13SPN	
	G 3/8	22	48	9		52SBAW17SPN	
	G 1/2	22	48	12		52SBAW21SPN	
 <p>Female Thread</p>	G 1/4	22	48	9		52SBIW13SPN	
	G 3/8	22	48	9		52SBIW17SPN	
 <p>Hose Barb</p>	6 mm	21	77,5	25		52SBTF06SPN	
	8 mm	21	77,5	25		52SBTF08SPN	
	9 mm	21	77,5	25		52SBTF09SPN	
	10 mm	21	77,5	25		52SBTF10SPN	
	13 mm	21	77,5	25		52SBTF13SPN	



Universal brass coupling with European standard industrial profile.
Coupling system with single-hand operation and standard-valve. Small mass size. The ergonomic sleeve design prevents dirt on the valve body.

Series 26 in brass material with nickel plating and with additional end connections available on request.

Working Temperature*

-20°C up to +100°C (NBR) depending on the medium.

* For temperatures below -20°C and over +100°C and depending on the medium, other seal variants (FKM, EPDM, FFKM) are available.

Other designs in series 26

The following other designs can be found from page:

- Safety Self-Venting P. 228



Working Pressure**

35 bar
** maximum static working pressure with design factor 4 to 1.

35 bar

Features

- Series 26 plugs in brass
- Series 25 steel plugs recommended for oscillating forces

Material

Coupling: Brass
Plug: Brass
Seals: NBR

Coupling: Brass
Plug: Brass
Seals: NBR

Technical Description

Connecting Force 0 bar: 40 N
Connecting Force 6 bar: 100 N

Vacuum Coupling: 96%
Vacuum connected: 96%

Dead space volume: 1,3 ml

Connecting Force 0 bar: 35 N
Connecting Force 6 bar: 80 N

Vacuum Coupling: 96%
Vacuum Plug: 96%
Vacuum connected: 96%

Interchangeability (KA only)

- Rectus 25
- Rectus 1600/1625
- Cejn 320
- JWL 520 + JWL 530
- various German Products

Flow diagrams

Air

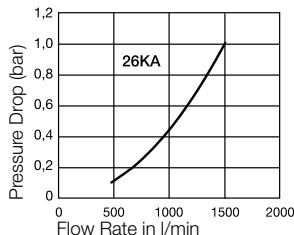

Air

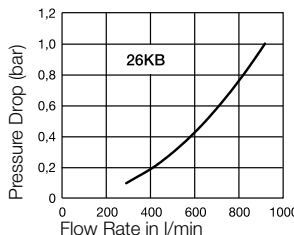

Water

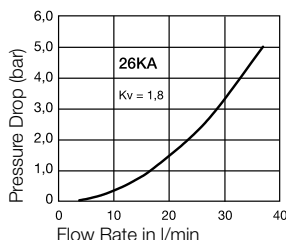

Water

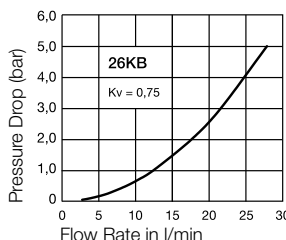

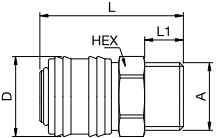
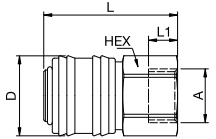
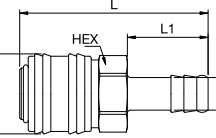
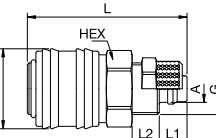
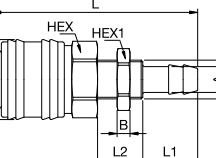
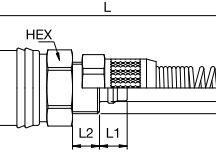

	Connection A	HEX mm	HEX1 mm	L mm	L1 mm	L2 mm	D mm	B mm	G mm	Version	Part Number
 <p>Male Thread</p>	G 1/8	22		43	9		25			blank	26KAAW10MPX
	G 1/4	22		39	9		25			blank	26KAAW13MPX
	G 3/8	22		41	9		25			blank	26KAAW17MPX
	G 1/2	22		44	12		25			blank	26KAAW21MPX
	G 1/2	24		44	12		25			blank	26KAAW21MPXS_36
	M 16 x 1,5	22		43	11		25			blank	26KAAD16MPX
 <p>Female Thread</p>	G 1/4	22		41	9		25			blank	26KAIW13MPX
	G 3/8	22		41	9		25			blank	26KAIW17MPX
	G 1/2	24		44	10		25			blank	26KAIW21MPX
	M 16 x 1,5	22		44	9		25			blank	26KAIM16MPX
	M 18 x 1,5	22		44	9		25			blank	26KAIM18MPX
 <p>Hose Barb</p>	6 mm	21		58	25		25			blank	26KATF06MPX
	8 mm	21		58	25		25			blank	26KATF08MPX
	9 mm	21		58	25		25			blank	26KATF09MPX
	10 mm	21		58	25		25			blank	26KATF10MPX
	13 mm	21		58	25		25			blank	26KATF13MPX
	6 mm Parker	21		58	20,5		25			blank	26KATP06MPX
	10 mm Parker	21		58	24		25			blank	26KATP10MPX
13 mm Parker	21		58	28		25			blank	26KATP13MPX	
 <p>with Plastic Hose Connection</p>	4 x 6 mm	21		58	7	6	25		M 10 x 1	blank	26KAKO06MPX
	6 x 8 mm	21		45	7	6	25		M 12 x 1	blank	26KAKO08MPX
	8 x 10 mm	21		49	9	8	25		M 16 x 1	blank	26KAKO10MPX
	9 x 12 mm	21		49	9	8	25		M 16 x 1	blank	26KAKO12MPX
 <p>Panel Mount with Hose Barb</p>	6 mm	21	17	60	17	10	25	4	M 12 x 1	blank	26KATS06MPX
	10 mm	21	17	72	25	14	25	4	G 1/4	blank	26KATS10MPX
 <p>Plastic Hose Connection with Spring Guard</p>	6 x 8 mm	21		132	7	6	25		M 12 x 1	blank	26KAKK08MPX
	8 x 10 mm	21		143	9	8	25		M 16 x 1	blank	26KAKK10MPX
	9 x 12 mm	21		150	9	8	25		M 16 x 1	blank	26KAKK12MPX



Plugs – without valve

Series 26KA

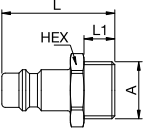
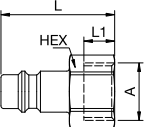
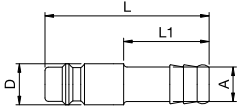
	Connection A	HEX mm	HEX1 mm	L mm	L1 mm	L2 mm	D mm	B mm	G mm	Version	Part Number
 <p>Male Thread</p>	G 1/8	14		31	7					blank	26SFAW10MXX
	G 1/8	14		31	7					nickel plated	26SFAW10MXN
	G 1/4	17		33	9					blank	26SFAW13MXX
	G 1/4	17		33	9					nickel plated	26SFAW13MXN
	G 3/8	19		33	9					blank	26SFAW17MXX
	G 3/8	19		33	9					nickel plated	26SFAW17MXN
	G 1/2	24		38	12					blank	26SFAW21MXX
	G 1/2	24		38	12					nickel plated	26SFAW21MXN
	M 14 x 1,5	17		35	10					blank	26SFAD14MXX
	M 16 x 1,5	19		36	11					blank	26SFAD16MXX
	M 16 x 1,5	19		36	11					nickel plated	26SFAD16MXN
M 18 x 1,5	22		37	11					blank	26SFAD18MXX	
 <p>Female Thread</p>	G 1/8	14		30	7					blank	26SFIW10MXX
	G 1/8	14		30	7					nickel plated	26SFIW10MXN
	G 1/4	17		33	10					blank	26SFIW13MXX
	G 1/4	17		33	10					nickel plated	26SFIW13MXN
	G 3/8	19		33	10					blank	26SFIW17MXX
	G 3/8	19		33	10					nickel plated	26SFIW17MXN
	G 1/2	24		35	12					blank	26SFIW21MXX
	G 1/2	24		35	12					nickel plated	26SFIW21MXN
M 16 x 1,5	19		33	10					blank	26SFIM16MXX	
 <p>Hose Barb</p>	4 mm			48	25		12			blank	26SFTF04MXX
	6 mm			48	25		12			blank	26SFTF06MXX
	6 mm			48	25		12			nickel plated	26SFTF06MXN
	8 mm			48	25		12			blank	26SFTF08MXX
	8 mm			48	25		12			nickel plated	26SFTF08MXN
	9 mm			48	25		12			blank	26SFTF09MXX
	9 mm			48	25		12			nickel plated	26SFTF09MXN
	10 mm			48	25		12			blank	26SFTF10MXX
	10 mm			48	25		12			nickel plated	26SFTF10MXN
	13 mm			48	25		15			blank	26SFTF13MXX
	13 mm			48	25		15			nickel plated	26SFTF13MXN
	6 mm Parker			43	20,5		16			blank	26SFTP06MXX
	6 mm Parker			43	20,5		16			nickel plated	26SFTP06MXN
	10 mm Parker			46	24		22			blank	26SFTP10MXX
	10 mm Parker			46	24		22			nickel plated	26SFTP10MXN
	13 mm Parker			50	28		24			blank	26SFTP13MXX
13 mm Parker			50	28		24			nickel plated	26SFTP13MXN	



Plugs – without valve

Series 26KA

Brass/Steel

Low Pressure

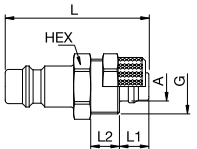
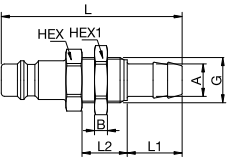
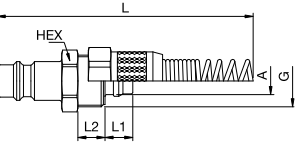
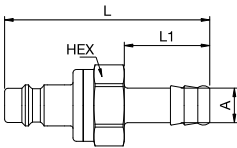
	Connection A	HEX mm	HEX1 mm	L mm	L1 mm	L2 mm	D mm	B mm	G mm	Version	Part Number
 <p>with Plastic Hose Connection</p>	4 x 6 mm			34	7	6	12		M 10 x 1	blank	26SFKO06MXX ¹
	4 x 6 mm			34	7	6	12		M 10 x 1	nickel plated	26SFKO06MXN ¹
	6 x 8 mm			34	7	6	12		M 12 x 1	blank	26SFKO08MXX ¹
	6 x 8 mm			34	7	6	12		M 12 x 1	nickel plated	26SFKO08MXN ¹
	8 x 10 mm	17		42	9	6			M 16 x 1	blank	26SFKO10MXX
	8 x 10 mm	17		42	9	6			M 16 x 1	nickel plated	26SFKO10MXN
	9 x 12 mm	17		42	9	8			M 16 x 1	blank	26SFKO12MXX
	9 x 12 mm	17		42	9	8			M 16 x 1	nickel plated	26SFKO12MXN
 <p>Panel Mount with Hose Barb</p>	10 mm	17	19	56	17	14		4	M 14 x 1	blank	26SFTS10MXX
	10 mm	17	19	56	17	14		4	M 14 x 1	nickel plated	26SFTS10MXN
 <p>Plastic Hose Connection with Spring Guard</p>	4 x 6 mm			120	7	6	12		M 10 x 1	blank	26SFKK06MXX ¹
	4 x 6 mm			120	7	6	12		M 10 x 1	nickel plated	26SFKK06MXN ¹
	6 x 8 mm			127	7	6	12		M 12 x 1	blank	26SFKK08MXX ¹
	6 x 8 mm			127	7	6	12		M 12 x 1	nickel plated	26SFKK08MXN ¹
	8 x 10 mm	17		135	9	8			M 16 x 1	blank	26SFKK10MXX
	8 x 10 mm	17		135	9	8			M 16 x 1	nickel plated	26SFKK10MXN
	9 x 12 mm	17		142	9	8			M 16 x 1	blank	26SFKK12MXX
	9 x 12 mm	17		142	9	8			M 16 x 1	nickel plated	26SFKK12MXN
 <p>Recoil Eliminator with Hose Barb</p>	6 mm	21		60	25					blank	26SRTF06MXX
	6 mm	21		60	25					nickel plated	26SRTF06MXN
	8 mm	21		60	25					blank	26SRTF08MXX
	8 mm	21		60	25					nickel plated	26SRTF08MXN
	9 mm	21		60	25					blank	26SRTF09MXX
	9 mm	21		60	25					nickel plated	26SRTF09MXN
	10 mm	21		60	25					blank	26SRTF10MXX
	10 mm	21		60	25					Nickel Plated	26SRTF10MXN
	13 mm	21		60	25					blank	26SRTF13MXX
	13 mm	21		60	25					nickel plated	26SRTF13MXN

¹ Plug without hexagon

Couplings – with valve **Series 26KB**

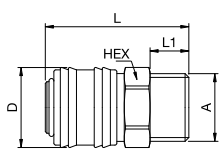
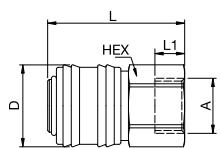
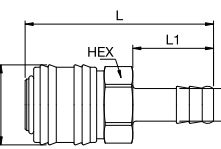
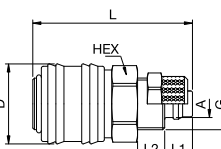
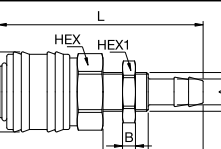
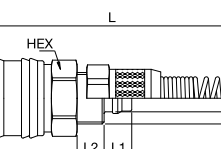
	Connection A	HEX mm	HEX1 mm	L mm	L1 mm	L2 mm	D mm	B mm	G mm	Version	Part Number
 <p>Male Thread</p>	G 1/8	22		43	9		25			blank	26KBAW10MPX
	G 1/4	22		39	9		25			blank	26KBAW13MPX
	G 3/8	22		41	9		25			blank	26KBAW17MPX
	G 1/2	24		42	10		25			blank	26KBAW21MPX
	M 16 x 1,5	22		43	11		25			blank	26KBAD16MPX
 <p>Female Thread</p>	G 1/4	22		41	9		25			blank	26KBIW13MPX
	G 3/8	22		41	9		25			blank	26KBIW17MPX
	G 1/2	24		44	10		25			blank	26KBIW21MPX
	M 16 x 1,5	22		44	9		25			blank	26KBIM16MPX
	M 18 x 1,5	22		44	9		25			blank	26KBIM18MPX
 <p>Hose Barb</p>	6 mm	21		58	25		25			blank	26KBTF06MPX
	8 mm	21		58	25		25			blank	26KBTF08MPX
	9 mm	21		58	25		25			blank	26KBTF09MPX
	10 mm	21		58	25		25			blank	26KBTF10MPX
	13 mm	21		58	25		25			blank	26KBTF13MPX
	6 mm Parker	21		58	25		25			blank	26KBTP06MPX
	10 mm Parker	21		58	24		25			blank	26KBTP10MPX
13 mm Parker	21		58	28		25			blank	26KBTP13MPX	
 <p>with Plastic Hose Connection</p>	6 x 8 mm	21		45	7	6	25		M 12 x 1	blank	26KBKO08MPX
	8 x 10 mm	21		49	9	8	25		M 16 x 1	blank	26KBKO10MPX
	9 x 12 mm	21		49	9	8	25		M 16 x 1	blank	26KBKO12MPX
 <p>Panel Mount with Hose Barb</p>	6 mm	21	17	60	17	10	25	4	M 12 x 1	blank	26KBTS06MPX
	10 mm	21	17	72	25	14	25	4	G 1/4	blank	26KBTS10MPX
 <p>Plastic Hose Connection with Spring Guard</p>	6 x 8 mm	21		132	7	6	25		M 12 x 1	blank	26KBKK08MPX
	8 x 10 mm	21		143	9	8	25		M 16 x 1	blank	26KBKK10MPX
	9 x 12 mm	21		150	9	8	25		M 16 x 1	blank	26KBKK12MPX



Connection A	HEX mm	HEX1 mm	L mm	L1 mm	L2 mm	D mm	B mm	G mm	Version	Part Number
The right plug for series 26KB can be found under series 25KB from page 73.										

Nominal Diameter

7,4 = 43 mm²



Tema Series

1300



energy saver

Series 1300 is used mainly for applications in the area of compressed air and liquids. Optimally suited to smaller to medium-sized pneumatic systems and to compressed air tools. The coupling series stands out for its compact design and high flow rates with the Ultra High Flow valve. Coupling body made of nitrocarburized steel.

Series 1300 with additional end connections available on request.

Dust Protections  (P. 250)
for Coupling Part.-No. 1315-QC
for Plug Part.-No. 1325-QC

Working Temperature*
-20°C up to +100°C (NBR)
depending on the medium.

* For temperatures below -20°C and over +100°C and depending on the medium, other seal variants (FKM, EPDM, FFKM) are available.

Other designs in series 1300

The following other designs can be found from page:

- Stainless Steel P. 146



Working Pressure**

35 bar
** maximum static working pressure with design factor 4 to 1.

50 bar

Features

- Single-hand operation
- Two-hand operation
- Special sealing system in the coupling increases the service life of the coupling

Material

Coupling: Brass nickel plated and chrome plated
Plug: Steel zinc plated
Seals: NBR

Coupling: Brass nickel plated and chrome plated
Plug: Brass nickel plated and chrome plated
Seals: NBR

Interchangeability (KA only)

- Cejn 303

Flow diagrams

Air

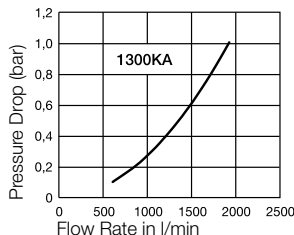

Water

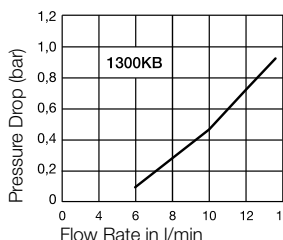



Couplings – with valve

Series 1300KA

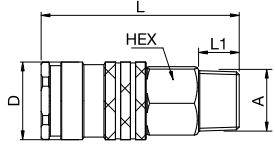
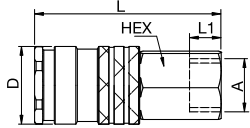
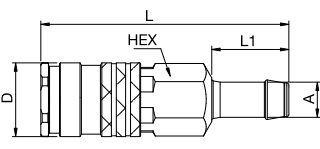
	Connection A	HEX mm	L mm	L1 mm	D mm	Part Number
 <p>Male Thread</p>	R 1/4	19	58	12	22	1300KAAK13MPN
	R 3/8	19	56	12	22	1300KAAK17MPN
	R 1/2	23	59	14	26	1300KAAK21MPN
 <p>Female Thread</p>	G 1/4	19	55	9	22	1300KAIW13MPN
	G 3/8	20	55	10	22	1300KAIW17MPN
 <p>Hose Barb</p>	6 mm	19	78	23	22	1300KATF06MPN
	8 mm	19	78	23	22	1300KATF08MPN
	10 mm	19	78	23	22	1300KATF10MPN
	13 mm	19	77	24	22	1300KATF13MPN



Plugs – without valve

Series 1300KA

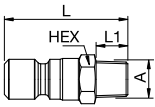
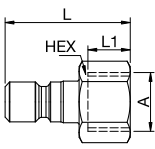
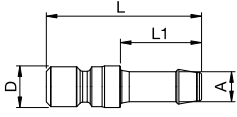
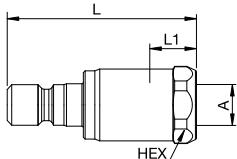
	Connection A	HEX mm	L mm	L1 mm	D mm	Part Number
 <p>Male Thread</p>	R 1/8	13	35	9		1300SFAK10SXZ
	R 1/4	17	38	12		1300SFAK13SXZ
	G 1/4	17	35	12		1300SFAW13SXZ
	R 3/8	17	38	12		1300SFAK17SXZ
	R 1/2	22	40	14		1300SFAK21SXZ
 <p>Female Thread</p>	G 1/8	13	32	8,5		1300SFIW10SXZ
	G 1/4	17	36	10		1300SFIW13SXZ
	G 3/8	22	36	10		1300SFIW17SXZ
	G 1/2	27	39	12		1300SFIW21SXZ
 <p>Hose Barb</p>	6 mm		44	23	12	1300SFTF06SXZ
	8 mm		44	23	12	1300SFTF08SXZ
	10 mm		44	24	12	1300SFTF10SXZ
	12 mm		47	23	12	1300SFTF12SXZ
 <p>Recoil Eliminator, with Female Thread</p>	G 1/4	20	53	12		1300SRIW13SXZ



Couplings – with valve

Series 1300KB

	Connection A	HEX mm	L mm	L1 mm	D mm	Part Number
<p>Male Thread</p>	G 3/8	18	49	7,5	22	1300KBAW17MPN
<p>Female Thread</p>	G 1/4	18	49	8	22	1300KBIW13MPN
	G 3/8	18	50	8	22	1300KBIW17MPN



Plugs – with valve

Series 1300KB





	Connection A	HEX mm	L mm	L1 mm	D mm	Part Number
<p>Female Thread</p>	G 1/4	18	44	9		1300SBIW13MPC

Protective Sleeve

Series 1300KB

	Description	L mm	D mm	Material	Color	Part Number
<p>Female Thread</p>	for Couplings 1300KB	73	33	EBA	blue	1300-351

Cross-Reference-List

Connection	Thread	Rectus Part Number old	Tema Part Number old	Part Number new	Page
 Couplings – with valve					
Male Thread	R 1/4	31KAAK13SPN	1300 EC	1300KAAK13MPN	65
	R 3/8	31KAAK17SPN	1300 EA	1300KAAK17MPN	65
	R 1/2	31KAAK21SPN	1300 ED	1300KAAK21MPN	65
Female Thread	G 1/4	31KAIW13SPN	1300 E	1300KAIW13MPN	65
	G 3/8	31KAIW17SPN	1300 EB	1300KAIW17MPN	65
Hose Barb	6 mm	31KATF06SPN	1300 EK06	1300KATF06MPN	65
	8 mm	31KATF08SPN	1300 EK08	1300KATF08MPN	65
	10 mm	31KATF10SPN	1300 EK10	1300KATF10MPN	65
	13 mm	31KATF13SPN	1300 EK12	1300KATF13MPN	65
 Plugs – without valve					
Male Thread	R 1/8	31SFAK10SXZ	13110-QC	1300SFAK10SXZ	65
	R 1/4	31SFAK13SXZ	13210 A	1300SFAK13SXZ	65
	G 1/4	31SFAW13SXZ	13210-QC	1300SFAW13SXZ	65
	R 3/8	31SFAK17SXZ	13220	1300SFAK17SXZ	65
	R 1/2	31SFAK21SXZ	13230	1300SFAK21SXZ	65
Female Thread	G 1/8	31SFIW10SXZ	13405	1300SFIW10SXZ	65
	G 1/4	31SFIW13SXZ	13410	1300SFIW13SXZ	65
	G 3/8	31SFIW17SXZ	13420	1300SFIW17SXZ	65
	G 1/2	31SFIW21SXZ	13430-QC	1300SFIW21SXZ	65
Hose Barb	6 mm	31SFTF06SXZ	13006	1300SFTF06SXZ	65
	8 mm	31SFTF08SXZ	13008-QC	1300SFTF08SXZ	65
	10 mm	31SFTF10SXZ	13010-QC	1300SFTF10SXZ	65
	12 mm	31SFTF13SXZ	13012-QC	1300SFTF12SXZ	65
Recoil Eliminator	G 1/4	-	13410 S	1300SRIW13SXZ	65
 Couplings – with valve					
Male Thread	G 3/8	-	1300 NA	1300KBAW17MPN	66
Female Thread	G 1/4	-	1300 N	1300KBIW13MPN	66
	G 3/8	-	1300 NB	1300KBIW17MPN	66
 Plugs – with valve					
Female Thread	G 1/4	-	13410 MN	1300SBIW13MPC	66

Nominal Diameter

7,5 = 45 mm²

Rectus Series

13

Robust brass coupling with Japanese industrial profile.
Coupling system with single-hand operation. Above average flow volumes and structure resistant to the effects of external forces.

Series 13 in brass material with nickel plating and with additional end connections available on request.

Working Temperature*

-20°C up to +100°C (NBR)
depending on the medium.

* For temperatures below -20°C and over +100°C and depending on the medium, other seal variants (FKM, EPDM, FFKM) are available.

**Working Pressure****

35 bar

** maximum static working pressure with design factor 4 to 1.

Material

Coupling: Brass
Plug: Steel nickel plated
Seals: NBR

Technical Description

Connecting Force 0 bar: 45 N
Connecting Force 6 bar: 105 N

Interchangeability (KA only)

- Nitto-Kohki 200
- Cejn 314
- Cejn 315

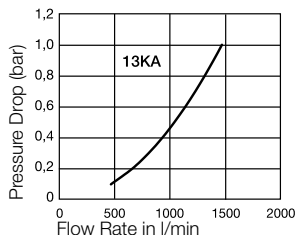
Flow diagrams**Air**



Coupling – with valve

Series 13KA

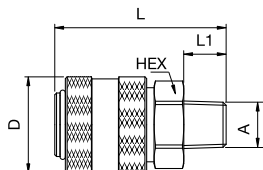
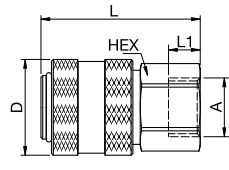
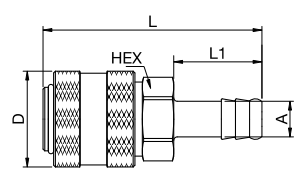
	Connection A	HEX mm	L mm	L1 mm	D mm	Part Number
 <p>Male Thread</p>	R 1/4	22	49	12	27	13KAAK13MPX
	R 3/8	22	49	12	27	13KAAK17MPX
	R 1/2	22	53	17	27	13KAAK21MPX
 <p>Female Thread</p>	G 1/4	22	45	9	27	13KAIW13MPX
	G 3/8	22	45	9	27	13KAIW17MPX
	G 1/2	24	48	12	27	13KAIW21MPX
 <p>Hose Barb</p>	6 mm	21	62	25	27	13KATF06MPX
	8 mm	21	62	25	27	13KATF08MPX
	10 mm	21	62	25	27	13KATF10MPX
	13 mm	21	62	25	27	13KATF13MPX



Plugs – without valve

Series 13KA

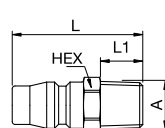
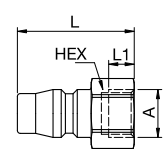
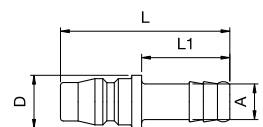
	Connection A	HEX mm	L mm	L1 mm	D mm	Part Number
 <p>Male Thread</p>	R 1/4	14	37	12		13SFAK13SXN
	R 3/8	17	37	12		13SFAK17SXN
	R 1/2	22	44	17		13SFAK21SXN
 <p>Female Thread</p>	G 1/4	17	34	9		13SFIW13SXN
	G 3/8	19	34	9		13SFIW17SXN
 <p>Hose Barb</p>	6 mm		48	25	15	13SFTF06SXN
	8 mm		48	25	15	13SFTF08SXN
	10 mm		48	25	15	13SFTF10SXN
	13 mm		48	25	15	13SFTF13SXN



Other designs in series 25

The following other designs can be found from page:

- Stainless Steel P. 150
- Safety P. 214
- Safety Self-Venting P. 230
- Coded Systems P. 236

Interchangeability (KA only)

- Rectus 26
- Rectus 1600/1625
- Cejn 320
- JWL 520 + JWL 530
- various German Products

Universal industrial coupling with standard European profile.
Coupling system with single-hand operation. High Flow valve for optimum flow and low pressure drop. The series stands out for its robust design and long service life even with the harshest use.

Series 25 with additional end connections available on request.

Dust Protections  (P. 250)
for Coupling Part.-No. SK23S
for Plug Part.-No. SK12S

Working Temperature*
-20°C up to +100°C (NBR)
depending on the medium.

* For temperatures below -20°C and over +100°C and depending on the medium, other seal variants (FKM, EPDM, FFKM) are available.



Working Pressure**

35 bar
** maximum static working pressure with design factor 4 to 1.

35 bar

Features

- Brass coupling and plug for use with water
- Robust coupling system with steel sleeve

Material

Coupling: Brass / Steel nickel plated
Plug: Steel zinc plated or Brass (Serie 26)
Seals: NBR

Coupling: Brass nickel plated
Plug: Brass nickel plated
Seals: NBR

Technical Description

Connecting Force 0 bar: 40 N
Connecting Force 6 bar: 120 N

Dead space volume: 1,5 ml

Connecting Force 0 bar: 40 N
Connecting Force 6 bar: 120 N

Vacuum Coupling: 96%
Available on request with O-ring seal for vacuum when coupled.

Vacuum Coupling: 96%
Vacuum Plug: 96%
Available on request with O-ring seal for vacuum when coupled.

Flow diagrams

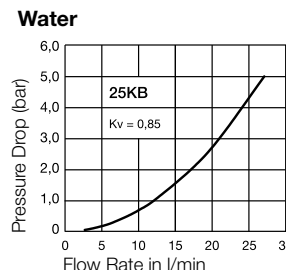
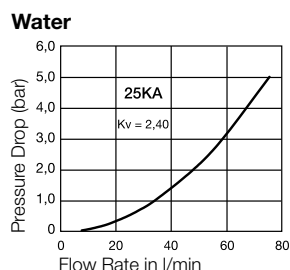
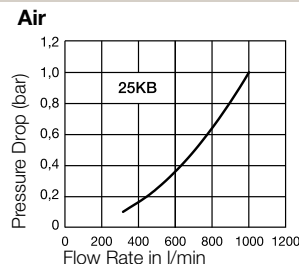
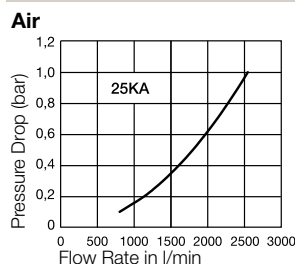



Coupling – with valve

Series 25KA

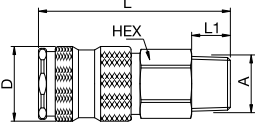
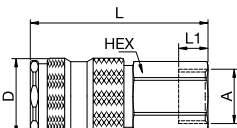
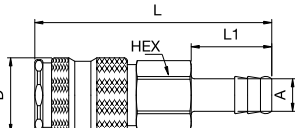
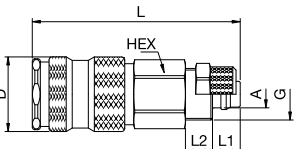
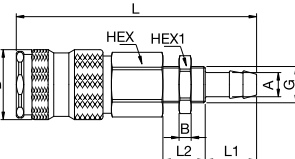
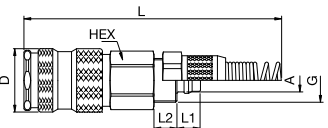
	Connection A	HEX mm	HEX1 mm	L mm	L1 mm	L2 mm	D mm	B mm	G mm	Version	Part Number
 <p>Male Thread</p>	R 1/4	19		60	12		23				25KAAK13MPN
	R 3/8	19		60	12		23				25KAAK17MPN
	R 1/2	22		61	17		23				25KAAK21MPN
	M 14 x 1,5	19		59	10		23				25KAAD14MPN
	M 16 x 1,5	19		60	11		23				25KAAD16MPN
 <p>Female Thread</p>	G 1/4	19		56	10		23				25KAIW13MPN
	G 3/8	19		55	9		23				25KAIW17MPN
	G 1/2	24		58	12		23				25KAIW21MPN
 <p>Hose Barb</p>	6 mm	19		74	25		23				25KATF06MPN
	8 mm	19		74	25		23				25KATF08MPN
	9 mm	19		74	25		23				25KATF09MPN
	10 mm	19		74	25		23				25KATF10MPN
	13 mm	19		74	25		23				25KATF13MPN
 <p>with Plastic Hose Connection</p>	6 x 8 mm	19		61	7	6	23		M 12 x 1		25KAKO08MPN
	9 x 12 mm	19		65	9	8	23		M 16 x 1		25KAKO12MPN
 <p>Panel Mount with Hose Barb</p>	6 mm	19	17	76	17	10	23	4	M 12 x 1		25KATS06MPN
 <p>Plastic Hose Connection with Spring Guard</p>	6 x 8 mm	19		144	7	6	23		M 12 x 1		25KAKK08MPN



Plugs – without valve

Series 25KA

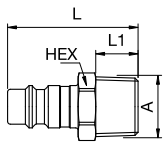
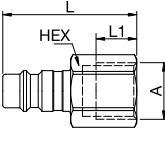
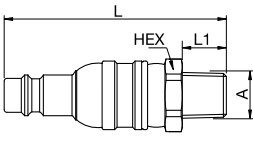
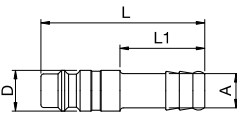
	Connection A	HEX mm	HEX1 mm	L mm	L1 mm	L2 mm	D mm	B mm	G mm	Version	Part Number	
 <p>Male Thread</p>	R 1/8	13		33	9						25SFAK10SXZ	
	R 1/4	14		36,5	12						25SFAK13SXZ	
	R 3/8	17		37	12						25SFAK17SXZ	
	R 1/2	22		43	17						25SFAK21SXZ	
 <p>Female Thread</p>	G 1/8	14		30	5						25SFIW10SXZ	
	G 1/4	17		38,5	12						25SFIW13SXZ	
	G 3/8	19		39,5	12						25SFIW17SXZ	
	G 1/2	24		44	14						25SFIW21SXZ	
 <p>Flex Joint, Male Thread</p>	R 1/4	17		64	11					nickel plated	25FAAK13SPN	
 <p>Hose Barb</p>	6 mm			48	25		12				25SFTF06SXZ	
	8 mm			48	25		12				25SFTF08SXZ	
	9 mm			48	25		12				25SFTF09SXZ	
	10 mm			48	25		12				25SFTF10SXZ	
	13 mm			48	25		15				25SFTF13SXZ	

The right plug in brass design can be found under series 26 from page 60.



Coupling – with valve

Series 25KB

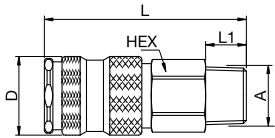
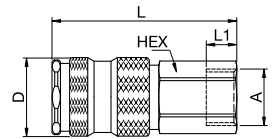
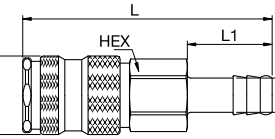
	Connection A	HEX mm	HEX1 mm	L mm	L1 mm	L2 mm	D mm	B mm	G mm	Version	Part Number
 <p>Male Thread</p>	R 1/4	19		60	12		23				25KBAK13BPN
	R 3/8	19		59	10,5		23				25KBAK17BPN
	R 1/2	22		57,5	9		23				25KBAK21BPN
	M 14 x 1,5	19		59	10		23				25KBAD14BPN
	M 16 x 1,5	19		60	11		23				25KBAD16BPN
 <p>Female Thread</p>	G 1/4	19		56	10		23				25KBIW13BPN
	G 3/8	19		55	9		23				25KBIW17BPN
	G 1/2	24		58	12		23				25KBIW21BPN
 <p>Hose Barb</p>	6 mm	19		74	25		23				25KBTf06BPN
	8 mm	19		74	25		23				25KBTf08BPN
	9 mm	19		74	25		23				25KBTf09BPN
	10 mm	19		74	25		23				25KBTf10BPN
	13 mm	19		74	25		23				25KBTf13BPN
	10 mm Parker	19		73	24		23				25KBTP10BPN
	13 mm Parker	19		76	28		23				25KBTP13BPN



Plugs – with valve

Series 25KB

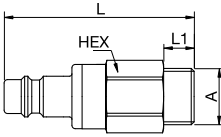
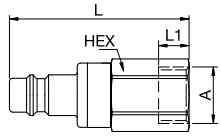
	Connection A	HEX mm	HEX1 mm	L mm	L1 mm	L2 mm	D mm	B mm	G mm	Version	Part Number
 <p>Male Thread</p>	G 1/8	22		44,5	9						25SBAW10MPN
	G 1/4	22		43	9						25SBAW13MPN
	G 3/8	22		43	9						25SBAW17MPN
	G 1/2	22		46	12						25SBAW21MPN
	M 14 x 1,5	22		44	10						25SBAD14MPN
	M 16 x 1,5	22		45	11						25SBAD16MPN
 <p>Female Thread</p>	G 1/4	22		43	10						25SBIW13MPN
	G 3/8	22		43	9						25SBIW17MPN
	G 1/2	24		46	9						25SBIW21MPN
	M 16 x 1,5	22		43	9						25SBIM16MPN
	M 18 x 1,5	22		43	9						25SBIM18MPN



Plugs – with valve

Series 25KB

	Connection A	HEX mm	HEX1 mm	L mm	L1 mm	L2 mm	D mm	B mm	G mm	Version	Part Number	
<p>Hose Barb</p>	6 mm	21		60	25						25SBTF06MPN	
	8 mm	21		60	25						25SBTF08MPN	
	9 mm	21		60	25						25SBTF09MPN	
	10 mm	21		60	25						25SBTF10MPN	
	13 mm	21		60	25						25SBTF13MPN	
	6 mm Parker	19		67,5	20,5							25SBTP06MPN
	10 mm Parker	19		71	24							25SBTP10MPN
13 mm Parker	19		83	28							25SBTP13MPN	
<p>with Plastic Hose Connection</p>	4 x 6 mm	21		47	7	6			M 10 x 1		25SBKO06MPN	
	6 x 8 mm	21		47	7	6			M 12 x 1		25SBKO08MPN	
	8 x 10 mm	21		51	8,5	8,5			M 16 x 1		25SBKO10MPN	
	9 x 12 mm	21		51	8,5	8,5			M 16 x 1		25SBKO12MPN	
<p>Panel Mount with Hose Barb</p>	6 mm	21	17	62	17	10		4	M 12 x 1		25SBTS06MPN	
	10 mm	21	17	74	25	14		3,5	G 1/4		25SBTS10MPN	
<p>Plastic Hose Connection with Spring Guard</p>	4 x 6 mm	19		120	7	6			M 10 x 1		25SBKK06MPN	
	6 x 8 mm	19		135	7	6			M 12 x 1		25SBKK08MPN	
	8 x 10 mm	19		145	8,5	8,5			M 16 x 1		25SBKK10MPN	
	9 x 12 mm	19		150	8,5	8,5			M 16 x 1		25SBKK12MPN	

Nominal Diameter

7,8 = 48 mm²

Rectus Series

1600**Other designs in series 1600**

The following other designs can be found from page:

- Safety Self-Venting P. 230

Interchangeability (KA only)

- Rectus 25 + 26
- Rectus 1625
- Cejn 320
- JWL 520 + JWL 530
- various German Products

Premium industrial coupling 3/8" with European standard profile. Suitable for compressed air applications with greater than average air consumption. Coupling system with single-hand operation. Ultra High Flow valve for optimum flow and low pressure drop.

Series 1600 with additional end connections available on request.

Dust Protections  (P. 250)
for Coupling Part.-No. SK23S
for Plug Part.-No. SK12S

Working Temperature*
-20°C up to +100°C (NBR)
depending on the medium.

* For temperatures below -20°C and over +100°C and depending on the medium, other seal variants (FKM, EPDM, FFKM) are available.

**Working Pressure****

35 bar

** maximum static working pressure with design factor 4 to 1.

Material

Coupling: Brass nickel plated,
Steel QPQ treated

Plug: Steel zinc plated

Seals: NBR

Technical Description

Connecting Force 0 bar: 30 N

Connecting Force 6 bar: 75 N

Vacuum Coupling: 87%

Vacuum connected: 87%

Flow diagrams

Air

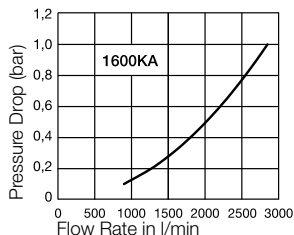



Coupling – with valve

Series 1600KA

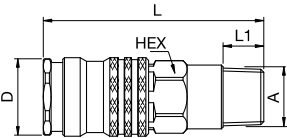
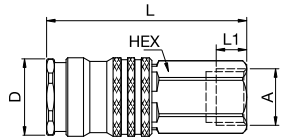
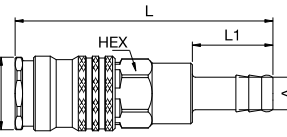
	Connection A	HEX mm	L mm	L1 mm	D mm	Part Number
 <p>Male Thread</p>	R 1/4	19	65	12	23	1600KAAK13SPN
	R 3/8	19	65	12	23	1600KAAK17SPN
	R 1/2	22	59,5	17	23	1600KAAK21SPN
 <p>Female Thread</p>	G 1/4	19	59	9	23	1600KAIW13SPN
	G 3/8	19	59	9	23	1600KAIW17SPN
	G 1/2	24	62	12	23	1600KAIW21SPN
 <p>Hose Barb</p>	6 mm	19	80	25	23	1600KATF06SPN
	8 mm	19	80	25	23	1600KATF08SPN
	9 mm	19	80	25	23	1600KATF09SPN
	10 mm	19	80	25	23	1600KATF10SPN
	13 mm	19	80	25	23	1600KATF13SPN



Plugs – without valve

Series 25SF

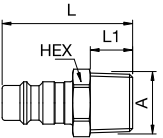
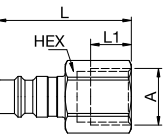
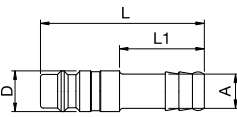
	Connection A	HEX mm	L mm	L1 mm	D mm	Part Number
 <p>Male Thread</p>	R 1/8	13	33	9		25SFAK10SXZ
	R 1/4	14	37	12		25SFAK13SXZ
	R 3/8	17	37	12		25SFAK17SXZ
	R 1/2	22	43	17		25SFAK21SXZ
 <p>Female Thread</p>	G 1/8	14	30	7		25SFIW10SXZ
	G 1/4	17	38,5	9		25SFIW13SXZ
	G 3/8	19	39,5	9		25SFIW17SXZ
	G 1/2	24	44	12		25SFIW21SXZ
 <p>Hose Barb</p>	6 mm		48	25	12	25SFTF06SXZ
	8 mm		48	25	12	25SFTF08SXZ
	9 mm		48	25	12	25SFTF09SXZ
	10 mm		48	25	12	25SFTF10SXZ
	13 mm		48	25	15	25SFTF13SXZ

Nominal Diameter

7,8 = 48 mm²

Rectus Series

1625

Premium industrial coupling 3/8" with European standard profile. Suitable for compressed air applications with greater than average air consumption. Coupling system with single-hand operation. Ultra High Flow valve for optimum flow and low pressure drop. Extremely robust and ergonomically shaped, 2-component plastic sleeve.

Series 1625 with additional end connections available on request.

Dust Protections  (P. 250)
for Coupling Part.-No. SK23S
for Plug Part.-No. SK12S

Working Temperature*
-20°C up to +40°C (NBR)
depending on the medium.

* For temperatures below -20°C and over +40°C and depending on the medium, other seal variants (FKM, EPDM, FFKM) are available.

**Working Pressure****

35 bar

** maximum static working pressure with design factor 4 to 1.

Material

Coupling: Brass nickel plated,
Steel QPQ treated, PA6+TPE

Plug: Steel zinc plated

Seals: NBR

Technical Description

Connecting Force 0 bar: 30 N

Connecting Force 6 bar: 75 N

Vacuum Coupling: 87%

Vacuum connected: 87%

Interchangeability (KA only)

- Rectus 25 + 26
- Rectus 1600
- Cejn 320
- JWL 520 + JWL 530
- various German Products

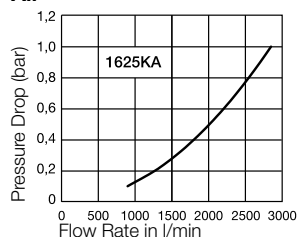
Flow diagrams**Air**



Coupling – with valve

Series 1625KA

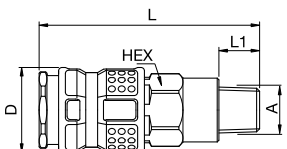
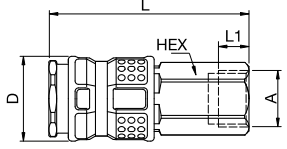
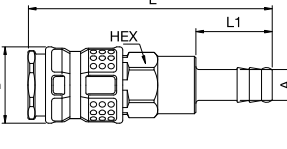
	Connection A	HEX mm	L mm	L1 mm	D mm	Part Number
 <p>Male Thread</p>	R 1/4	19	65	12	26	1625KAAK13SPN
	R 3/8	19	65	12	26	1625KAAK17SPN
	R 1/2	22	59,5	17	26	1625KAAK21SPN
 <p>Female Thread</p>	G 1/4	19	59	9	26	1625KAIW13SPN
	G 3/8	19	59	9	26	1625KAIW17SPN
	G 1/2	24	62	12	26	1625KAIW21SPN
 <p>Hose Barb</p>	6 mm	19	80	25	26	1625KATF06SPN
	8 mm	19	80	25	26	1625KATF08SPN
	9 mm	19	80	25	26	1625KATF09SPN
	10 mm	19	80	25	26	1625KATF10SPN
	13 mm	19	80	25	26	1625KATF13SPN



Plugs – without valve

Series 25SF

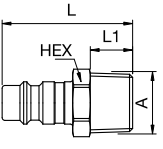
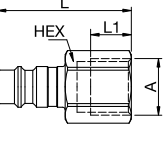
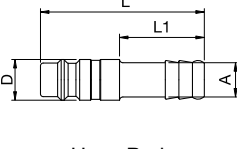
	Connection A	HEX mm	L mm	L1 mm	D mm	Part Number
 <p>Male Thread</p>	R 1/8	13	33	9		25SFAK10SXZ
	R 1/4	14	37	12		25SFAK13SXZ
	R 3/8	17	37	12		25SFAK17SXZ
	R 1/2	22	43	17		25SFAK21SXZ
 <p>Female Thread</p>	G 1/8	14	30	7		25SFIW10SXZ
	G 1/4	17	38,5	9		25SFIW13SXZ
	G 3/8	19	39,5	9		25SFIW17SXZ
	G 1/2	24	44	12		25SFIW21SXZ
 <p>Hose Barb</p>	6 mm		48	25	12	25SFTF06SXZ
	8 mm		48	25	12	25SFTF08SXZ
	9 mm		48	25	12	25SFTF09SXZ
	10 mm		48	25	12	25SFTF10SXZ
	13 mm		48	25	15	25SFTF13SXZ

8 = 50 mm²

33



Steel industrial coupling with Atlas Copco-Profile. Specially suited to use with gaseous media in industry.

Coupling system with single-hand operation. High Flow valve for optimum flow and low pressure drop.

Series 33 with additional end connections available on request.

Dust Protections  (P. 250)
for Coupling Part.-No. SK23S
for Plug Part.-No. SK12S

Working Temperature*
-20°C up to +100°C (NBR)
depending on the medium.

* For temperatures below -20°C and over +100°C and depending on the medium, other seal variants (FKM, EPDM, FFKM) are available.

**Working Pressure****

35 bar

** maximum static working pressure with design factor 4 to 1.

Material

Coupling: Brass / Steel nickel plated

Plug: Steel nickel plated

Seals: NBR

Technical Description

Connecting Force 0 bar: 40 N

Connecting Force 6 bar: 130 N

Vacuum Coupling: 96%

Vacuum connected: 96%

Interchangeability (KA only)

- Atlas Copco QIC 10

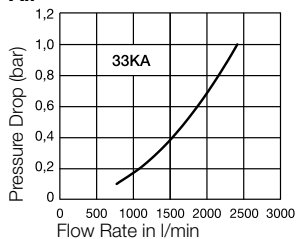
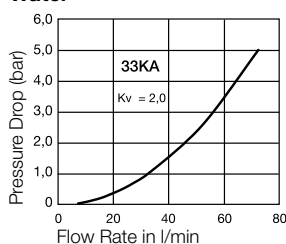
Flow diagrams**Air****Water**



Coupling – with valve

Series 33KA

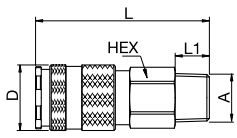
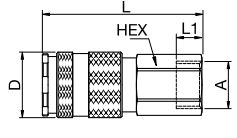
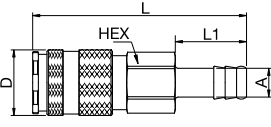
	Connection A	HEX mm	L mm	L1 mm	D mm	Part Number
 Male Thread	R 1/4	19	60	12	23	33KAAK13SPN
	R 3/8	19	59	12	23	33KAAK17SPN
	R 1/2	22	60	17	23	33KAAK21SPN
 Female Thread	G 1/4	19	55	10	23	33KAIW13SPN
	G 3/8	19	54	9	23	33KAIW17SPN
	G 1/2	24	57	12	23	33KAIW21SPN
 Hose Barb	6 mm	19	73	25	23	33KATF06SPN
	8 mm	19	73	25	23	33KATF08SPN
	10 mm	19	73	25	23	33KATF10SPN
	13 mm	19	73	25	23	33KATF13SPN



Plugs – without valve

Series 33KA

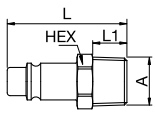
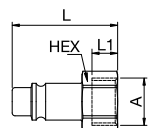
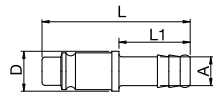
	Connection A	HEX mm	L mm	L1 mm	D mm	Part Number	
 Male Thread	R 1/4	14	42	12		33SFAK13SXN	
	R 3/8	17	42	12		33SFAK17SXN	
	R 1/2	22	47	17		33SFAK21SXN	
 Female Thread	G 1/4	17	37	9		33SFIW13SXN	
	G 3/8	17	37	9		33SFIW17SXN	
 Hose Barb	6 mm		52	25	14	33SFTF06SXN	
	8 mm		52	25	14	33SFTF08SXN	
	10 mm		52	25	15	33SFTF10SXN	
	13 mm		52	25	15	33SFTF13SXN	

Nominal Diameter

8,5 = 60 mm²

Rectus Series

30

Steel coupling 3/8" according to ISO 6150 B and US MIL-SPEC 4109. Very robust design with steel valve bodies. The high insertion depth is guaranteed by an optimised plug guide.

Series 30 in brass material with nickel plating and with additional end connections available on request.

Working Temperature*

-20°C up to +100°C (NBR)
depending on the medium.

* For temperatures below -20°C and over +100°C and depending on the medium, other seal variants (FKM, EPDM, FFKM) are available.

**Working Pressure****

35 bar

** maximum static working pressure with design factor 4 to 1.

Material

Coupling: Brass / Steel

Plug: Steel nickel plated

Seals: NBR

Technical Description

Connecting Force 0 bar: 50 N

Connecting Force 6 bar: 110 N

Vacuum Coupling: 96%

Vacuum connected: 96%

Interchangeability (KA only)

- Industrial. Interchange 3/8"
- US-MIL-SPEC-C-4109
- ISO 6150 B
- Gromelle 900
- Hansen 4000
- Parker 30 3/8"

Flow diagrams

Air

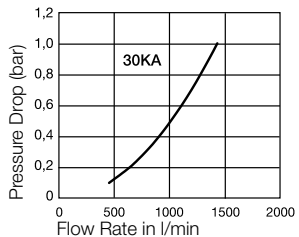



Couplings – with valve

Series 30KA

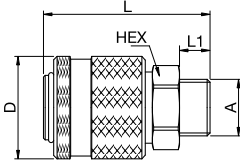
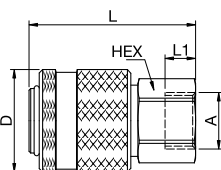
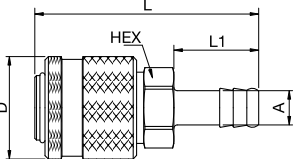
	Connection A	HEX mm	L mm	L1 mm	D mm	Part Number
 <p>Male Thread</p>	G 1/4	22	49	9	30	30KAAW13SPX
	G 3/8	22	49	9	30	30KAAW17SPX
	G 1/2	22	52	12	30	30KAAW21SPX
 <p>Female Thread</p>	G 1/4	22	49	11	30	30KAIW13SPX
	G 3/8	22	49	9	30	30KAIW17SPX
	G 1/2	22	52	12	30	30KAIW21SPX
 <p>Hose Barb</p>	6 mm	21	66	25	30	30KATF06SPX
	8 mm	21	66	25	30	30KATF08SPX
	10 mm	21	66	25	30	30KATF10SPX
	13 mm	21	66	25	30	30KATF13SPX



Plugs – without valve

Series 30KA

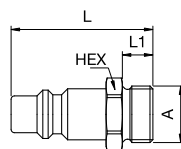
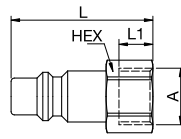
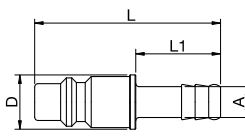
	Connection A	HEX mm	L mm	L1 mm	D mm	Part Number
 <p>Male Thread</p>	G 1/4	17	42	9		30SFAW13SXN
	G 3/8	19	42	9		30SFAW17SXN
	G 1/2	24	46	12		30SFAW21SXN
 <p>Female Thread</p>	G 1/4	17	40	10		30SFIW13SXN
	G 3/8	19	42	10		30SFIW17SXN
	G 1/2	24	43	12		30SFIW21SXN
 <p>Hose Barb</p>	8 mm		55	25	16	30SFTF08SXN
	10 mm		55	25	16	30SFTF10SXN
	13 mm		55	25	16	30SFTF13SXN

9 = 63 mm²



40



Brass coupling system produced for raw applications. The system is suitable for use with non-aggressive liquid media. The couplings are corrosion resistant.

Coupling system with single-hand operation. The ergonomic sleeve design prevents dirt on the valve body.

Series 40 in brass material without nickel plating and with additional end connections available on request.

Working Temperature*

-20°C up to +100°C (NBR)
depending on the medium.

* For temperatures below -20°C and over +100°C and depending on the medium, other seal variants (FKM, EPDM, FFKM) are available.



Working Pressure**

35 bar

** maximum static working pressure with design factor 4 to 1.

Material

Coupling: Brass nickel plated

Plug: Steel nickel plated

Seals: NBR

Technical Description

Connecting Force 0 bar: 60 N

Connecting Force 6 bar: 120 N

Vacuum Coupling: 60%

Vacuum connected: 96%

Interchangeability (KA only)

- ARO 310
- Orion 44520
- Orion 44530

Flow diagrams

Air

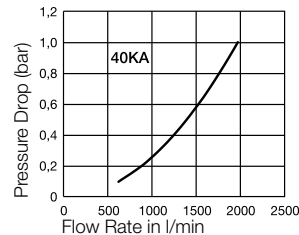

Water

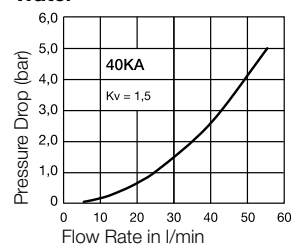



Couplings – with valve

Series 40KA

	Connection A	HEX mm	L mm	L1 mm	D mm	Part Number
<p>Female Thread</p>	G 3/8	27	46	10	32	40KAIW17MPN
	G 1/2	27	46	11	32	40KAIW21MPN



Plugs – without valve

Series 40KA

	Connection A	HEX mm	L mm	L1 mm	D mm	Part Number
<p>Male Thread</p>	R 3/8	16	40	12		40SFAK17SXN
	R 1/2	16	46	17		40SFAK21SXN
<p>Female Thread</p>	G 3/8	19	35	9		40SFIW17SXN
	G 1/2	24	39	12		40SFIW21SXN
<p>Hose Barb</p>	8 mm		51	25	16	40SFTF08SXN
	10 mm		51	25	16	40SFTF10SXN
	13 mm		51	25	16	40SFTF13SXN

Nominal Diameter

10 = 80 mm²



Rectus Series

27



1/2" universal industrial coupling with standard European profile for use with large pneumatic consumers. Coupling system with single-hand operation. High Flow valve for optimum flow and low pressure drop. The series stands out for its robust design (steel sleeve), extremely high flow and long service life even with the harshest use. The collar design minimises damage to the valve body.

Series 27 in brass material with nickel plating and with additional end connections available on request.

Dust Protections  (P. 250) for Coupling Part.-No. SK27S

Working Temperature*
-20°C up to +100°C (NBR) depending on the medium.

* For temperatures below -20°C and over +100°C and depending on the medium, other seal variants (FKM, EPDM, FFKM) are available.

Other designs in series 27

The following other designs can be found from page:

- Stainless Steel P. 156
- Safety Self-Venting P. 232

Interchangeability (KA only)

- Rectus 41
- Rectus 1700
- Rectus 1727
- Cejn 410



Working Pressure**

35 bar
** maximum static working pressure with design factor 4 to 1.

35 bar

Material

Coupling: Brass / Steel nickel plated
Plug: Steel nickel plated
Seals: NBR

Coupling: Brass
Plug: Brass nickel plated
Seals: NBR

Technical Description

Connecting Force 0 bar: 60 N
Connecting Force 6 bar: 180 N

Dead space volume: 2,2 ml

Vacuum Coupling: 87%
Available on request with O-ring seal for vacuum when coupled.

Connecting Force 0 bar: 60 N
Connecting Force 6 bar: 180 N

Vacuum Coupling: 96%
Vacuum Plug: 96%
Available on request with O-ring seal for vacuum when coupled.

Flow diagrams

Air

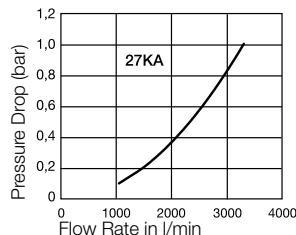

Air

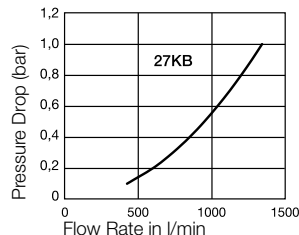

Water

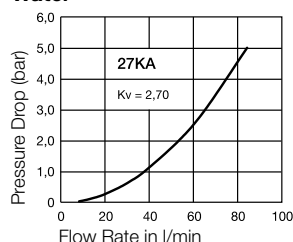

Water

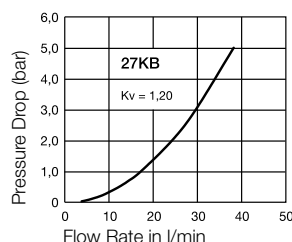



Couplings – with valve

Series 27KA

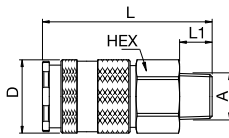
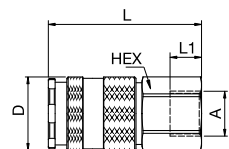
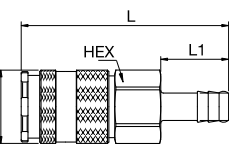
	Connection A	HEX mm	L mm	L1 mm	D mm	Part Number
 <p>Male Thread</p>	R 1/4	24	63	12	27	27KAAK13MPN
	R 3/8	24	63	12	27	27KAAK17MPN
	R 1/2	24	65	17	27	27KAAK21MPN
	R 3/4	27	65	17	27	27KAAK26MPN
 <p>Female Thread</p>	G 1/4	24	56	10	27	27KAIW13MPN
	G 3/8	24	56	11	27	27KAIW17MPN
	G 1/2	24	56	12	27	27KAIW21MPN
	G 3/4	27	60	16	27	27KAIW26MPN
 <p>Hose Barb</p>	6 mm	24	76	25	27	27KATF06MPN
	8 mm	24	76	25	27	27KATF08MPN
	9 mm	24	76	25	27	27KATF09MPN
	10 mm	24	76	25	27	27KATF10MPN
	13 mm	24	76	25	27	27KATF13MPN
	16 mm	24	76	20	27	27KATF16MPN
	19 mm	24	76	25	27	27KATF19MPN



Plugs – without valve

Series 27KA

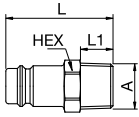
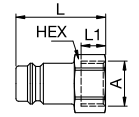
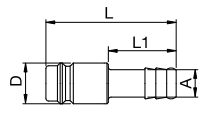
	Connection A	HEX mm	L mm	L1 mm	D mm	Part Number
 <p>Male Thread</p>	R 1/4	17	40	12		27SFAK13SXN
	R 3/8	17	40	12		27SFAK17SXN
	R 1/2	22	45	17		27SFAK21SXN
	R 3/4	27	48	19		27SFAK26SXN
 <p>Female Thread</p>	G 1/4	17	33	9		27SFIW13SXN
	G 3/8	19	33	12		27SFIW17SXN
	G 1/2	24	37	12		27SFIW21SXN
	G 3/4	32	42	16		27SFIW26SXN
 <p>Hose Barb</p>	6 mm		48	25	15	27SFTF06SXN
	8 mm		48	25	15	27SFTF08SXN
	9 mm		48	25	15	27SFTF09SXN
	10 mm		48	25	15	27SFTF10SXN
	13 mm		48	25	15	27SFTF13SXN
	16 mm		49	25	18	27SFTF16SXN
	19 mm		49	25	21	27SFTF19SXN



Couplings – with valve

Series 27KB

	Connection A	HEX mm	L mm	L1 mm	D mm	Part Number
<p>Male Thread</p>	R 1/4	24	63	12	27	27KBAK13BPN
	R 3/8	24	63	12	27	27KBAK17BPN
	R 1/2	24	65	17	27	27KBAK21BPN
	R 3/4	27	65	17	27	27KBAK26BPN
<p>Female Thread</p>	G 1/4	24	56	10	27	27KBIW13BPN
	G 3/8	24	56	11	27	27KBIW17BPN
	G 1/2	24	56	12	27	27KBIW21BPN
	G 3/4	32	60	16	27	27KBIW26BPN
<p>Hose Barb</p>	8 mm	24	76	25	27	27KBTF08BPN
	9 mm	24	76	25	27	27KBTF09BPN
	10 mm	24	76	25	27	27KBTF10BPN
	13 mm	24	76	25	27	27KBTF13BPN
	16 mm	24	76	25	27	27KBTF16BPN
	19 mm	24	76	25	27	27KBTF19BPN



Plugs – with valve

Series 27KB

	Connection A	HEX mm	L mm	L1 mm	D mm	Part Number
<p>Male Thread</p>	R 1/4	24	60,5	12		27SBAK13MPN
	R 3/8	24	60,5	12		27SBAK17MPN
	R 1/2	24	62,5	17		27SBAK21MPN
	R 3/4	27	62,5	17		27SBAK26MPN
<p>Female Thread</p>	G 3/8	24	54,5	9		27SBIW17MPN
	G 1/2	24	54,5	12		27SBIW21MPN
	G 3/4	32	58,5	16		27SBIW26MPN
<p>Hose Barb</p>	9 mm	24	74	25		27SBTF09MPN
	10 mm	24	74	25		27SBTF10MPN
	13 mm	24	74	25		27SBTF13MPN
	16 mm	24	74	25		27SBTF16MPN
	19 mm	24	74	25		27SBTF19MPN

Nominal Diameter

10 = 80 mm²

Rectus Series

1700**Other designs in series 1700**

The following other designs can be found from page:

- ▶ Stainless Steel P. 156
- ▶ Safety Self-Venting P. 232

Interchangeability (KA only)

- Rectus 27
- Rectus 1727
- Cejn 410

Premium industrial coupling 1/2" with standard European profile. Suitable for compressed air applications with greater than average air consumption. Above-average flow values compared with standard market products.

Coupling system with single-hand operation. Ultra High Flow valve for optimum flow and low pressure drop.

Series 1700 with additional end connections available on request.

Dust Protections  (P. 250)
for Coupling Part.-No. SK27S

Working Temperature*
-20°C up to +100°C (NBR)
depending on the medium.

* For temperatures below -20°C and over +100°C and depending on the medium, other seal variants (FKM, EPDM, FFKM) are available.

**Working Pressure****

35 bar

** maximum static working pressure with design factor 4 to 1.

Material

Coupling: Brass nickel plated,
Steel QPQ treated

Plug: Steel nickel plated

Seals: NBR

Technical Description

Connecting Force 0 bar: 40 N

Connecting Force 6 bar: 120 N

Flow diagrams

Air

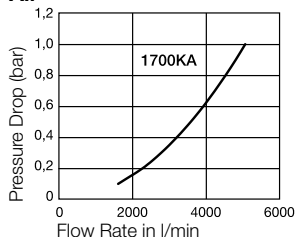



Couplings – with valve

Series 1700KA

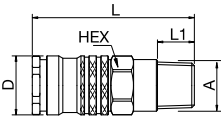
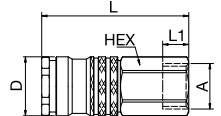
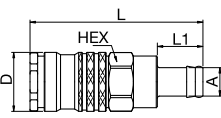
	Connection A	HEX mm	L mm	L1 mm	D mm	Part Number
 <p>Male Thread</p>	R 3/8	24	70	12	27	1700KAAK17SPN
	R 1/2	24	75	17	27	1700KAAK21SPN
	R 3/4	27	64	17	27	1700KAAK26SPN
 <p>Female Thread</p>	G 3/8	24	64,5	10	27	1700KAIW17SPN
	G 1/2	24	68	11	27	1700KAIW21SPN
	G 3/4	32	69	14	27	1700KAIW26SPN
 <p>Hose Barb</p>	10 mm	24	80	21	27	1700KATF10SPN
	13 mm	24	80	21	27	1700KATF13SPN
	16 mm	24	80	21	27	1700KATF16SPN



Plugs – without valve

Series 27SF

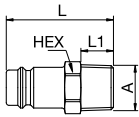
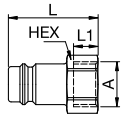
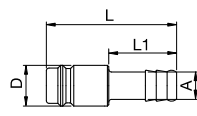
	Connection A	HEX mm	L mm	L1 mm	D mm	Part Number
 <p>Male Thread</p>	R 1/4	17	40	12		27SFAK13SXN
	R 3/8	17	40	12		27SFAK17SXN
	R 1/2	22	45	17		27SFAK21SXN
	R 3/4	27	48	19		27SFAK26SXN
 <p>Female Thread</p>	G 1/4	17	33	9		27SFIW13SXN
	G 3/8	19	33	12		27SFIW17SXN
	G 1/2	24	37	12		27SFIW21SXN
	G 3/4	32	42	16		27SFIW26SXN
 <p>Hose Barb</p>	6 mm		48	25	15	27SFTF06SXN
	8 mm		48	25	15	27SFTF08SXN
	9 mm		48	25	15	27SFTF09SXN
	10 mm		48	25	15	27SFTF10SXN
	13 mm		48	25	15	27SFTF13SXN
	16 mm		49	25	18	27SFTF16SXN
19 mm		49	25	21	27SFTF19SXN	

Nominal Diameter

10 = 80 mm²

Rectus Series

1727energy
saver**Other designs in series 1727**

The following other designs can be found from page:

- ▶ Stainless Steel P. 156
- ▶ Safety Self-Venting P. 232

Interchangeability (KA only)

- Rectus 27
- Rectus 1700
- Cejn 410

Premium industrial coupling 1/2" with standard European profile. Suitable for compressed air applications with greater than average air consumption. Above-average flow values compared with standard market products.

Coupling system with single-hand operation. Ultra High Flow valve for optimum flow and low pressure drop. Extremely robust and ergonomically shaped, 2-component plastic sleeve.

Series 1727 with additional end connections available on request.

Dust Protections  (P. 250)
for Coupling Part.-No. SK27S
for Plug Part.-No. SK16S

Working Temperature*
-20°C up to +40°C (NBR)
depending on the medium.

* For temperatures below -20°C and over +40°C and depending on the medium, other seal variants (FKM, EPDM, FFKM) are available.

**Working Pressure****

35 bar

** maximum static working pressure with design factor 4 to 1.

Material

Coupling: Brass nickel plated,
Steel QPQ treated, PA6+TPE

Plug: Steel nickel plated

Seals: NBR

Technical Description

Connecting Force 0 bar: 40 N

Connecting Force 6 bar: 120 N

Flow diagrams

Air

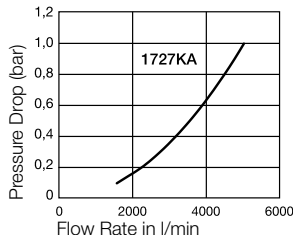



Couplings – with valve

Series 1727KA

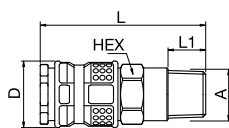
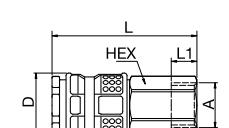
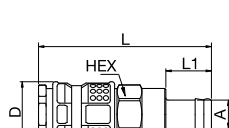
	Connection A	HEX mm	L mm	L1 mm	D mm	Part Number
 <p>Male Thread</p>	R 3/8	24	70	12	30	1727KAAK17SPN
	R 1/2	24	75	17	30	1727KAAK21SPN
	R 3/4	27	64	17	30	1727KAAK26SPN
 <p>Female Thread</p>	G 3/8	24	64,5	10	30	1727KAIW17SPN
	G 1/2	24	68	12	30	1727KAIW21SPN
	G 3/4	32	69	14	30	1727KAIW26SPN
 <p>Hose Barb</p>	10 mm	24	80	21	30	1727KATF10SPN
	13 mm	24	80	21	30	1727KATF13SPN
	16 mm	24	80	21	30	1727KATF16SPN



Plugs – without valve

Series 27SF

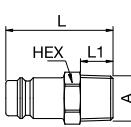
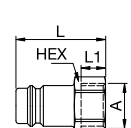
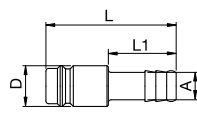
	Connection A	HEX mm	L mm	L1 mm	D mm	Part Number
 <p>Male Thread</p>	R 1/4	17	40	12		27SFAK13SXN
	R 3/8	17	40	12		27SFAK17SXN
	R 1/2	22	45	17		27SFAK21SXN
	R 3/4	27	48	19		27SFAK26SXN
 <p>Female Thread</p>	G 1/4	17	33	9		27SFIW13SXN
	G 3/8	19	33	12		27SFIW17SXN
	G 1/2	24	37	12		27SFIW21SXN
	G 3/4	32	42	16		27SFIW26SXN
 <p>Hose Barb</p>	6 mm		48	25	15	27SFTF06SXN
	8 mm		48	25	15	27SFTF08SXN
	9 mm		48	25	15	27SFTF09SXN
	10 mm		48	25	15	27SFTF10SXN
	13 mm		48	25	15	27SFTF13SXN
	16 mm		49	25	18	27SFTF16SXN
	19 mm		49	25	21	27SFTF19SXN

Nominal Diameter

10 = 80 mm²



Tema Series

1800



Series 1800 is used mainly for applications in the area of compressed air and liquids. The coupling system stands out for its robust, compact design and high corrosion resistance. Ultra High Flow valve for optimum flow and low pressure drop.

Series 1800 with additional end connections available on request.

Dust Protections  (P. 250)
for Coupling Part.-No. 5026-QC
for Plug Part.-No. 2526-QC

Working Temperature*
-20°C up to +100°C (NBR)
depending on the medium.

* For temperatures below -20°C and over +100°C and depending on the medium, other seal variants (FKM, EPDM, FFKM) are available.



Working Pressure**

35 bar

** maximum static working pressure with design factor 4 to 1.

50 bar

Features

- Single-hand operation
- Particularly suited to medium-sized to large pneumatic systems and compressed air tools

- Two-hand operation
- Special disc shape of the main seal in the coupling extends the durability
- Particularly suited to applications in the area of liquids, which require a coupling that is simple and easy to handle

Material

Coupling: Brass nickel plated and chrome plated
Plug: Steel hardened, zinc plated
Seals: NBR

Coupling: Brass nickel plated and chrome plated
Plug: Brass nickel plated and chrome plated
Seals: NBR

Other designs in series 1800

The following other designs can be found from page:

- Stainless Steel P. 160

Interchangeability (KA only)

- Cejn 408

Flow diagrams

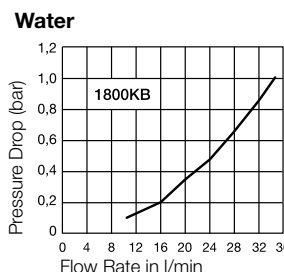
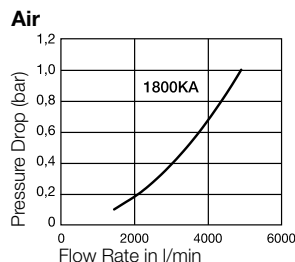



Couplings – with valve

Series 1800KA

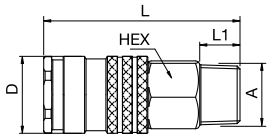
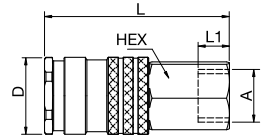
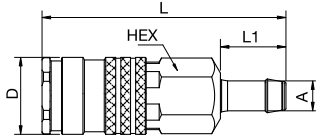
	Connection A	HEX mm	L mm	L1 mm	D mm	Part Number
 <p>Male Thread</p>	R 3/8	23	69	11	27	1800KAAK17MPN
	R 1/2	23	69	13	27	1800KAAK21MPN
	R 3/4	27	73	15	27	1800KAAK26MPN
 <p>Female Thread</p>	G 3/8	23	65	10	27	1800KAIW17MPN
	G 1/2	25	65	10	27	1800KAIW21MPN
	G 3/4	30	67	11	27	1800KAIW26MPN
 <p>Hose Barb</p>	10 mm	23	82	23	27	1800KATF10MPN
	13 mm	23	82	24	27	1800KATF13MPN
	16 mm	23	82	24	27	1800KATF16MPN
	19 mm	23	82	24	27	1800KATF19MPN



Plugs – without valve

Series 1800KA

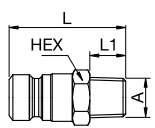
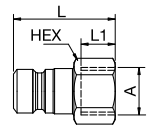
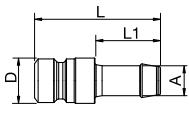
	Connection A	HEX mm	L mm	L1 mm	D mm	Part Number
 <p>Male Thread</p>	R 1/8	17	36	10		1800SFAK10SXZ
	R 1/4	17	39	12		1800SFAK13SXZ
	G 1/4	17	35	9		1800SFAW13SXZ
	R 3/8	17	38	12		1800SFAK17SXZ
	G 3/8	22	36	10		1800SFAW17SXZ
	R 1/2	22	40	14		1800SFAK21SXZ
	R 3/4	27	43	16		1800SFAK26SXZ
 <p>Female Thread</p>	G 1/4	17	36	10		1800SFIW13SXZ
	G 3/8	22	36	10		1800SFIW17SXZ
	G 1/2	27	39	12		1800SFIW21SXZ
 <p>Hose Barb</p>	6 mm		44	23	16	1800SFTF06SXZ
	8 mm		44	23	16	1800SFTF08SXZ
	10 mm		44	23	16	1800SFTF10SXZ
	13 mm		45	24	16	1800SFTF12SXZ
	16 mm		47	24	18	1800SFTF16SXZ
	19 mm		47	24	23	1800SFTF19SXZ



Couplings – with valve

Series 1800KB

	Connection A	HEX mm	L mm	L1 mm	D mm	Part Number
<p>Male Thread</p>	G 1/2	22	54	10	27	1800KBAW21MPN
<p>Female Thread</p>	G 3/8	22	54	9	27	1800KBIW17MPN
	G 1/2	25	55	9	27	1800KBIW21MPN
	G 3/4	30	57	11	27	1800KBIW26MPN



Plugs – with valve

Series 1800KB



	Connection A	HEX mm	L mm	L1 mm	D mm	Part Number
<p>Male Thread</p>	1/2 - 14NPTF	22	47	19		1800SBAN21MPC
<p>Female Thread</p>	G 3/8	22	49	10		1800SBIW17MPC
	G 3/4	30	54	12		1800SBIW26MPC

Protective Sleeve



Series 1800KB

	Description	L mm	D mm	Version	Color	Part Number
	for Couplings 1800KB	78	38	EBA	blue	1800-351

Cross-Reference-List

Connection	Thread	Rectus Part Number old	Tema Part Number old	Part Number new	Page
 Couplings – with valve					
Male Thread	R 3/8		1800 ED	1800KAAK17MPN	95
	R 1/2	32KAAK21MPN	1800 EA	1800KAAK21MPN	95
	R 3/4		1800 EF	1800KAAK26MPN	95
Female Thread	G 3/8	32KAIW17MPN	1800 E	1800KAIW17MPN	95
	G 1/2	32KAIW21MPN	1800 EB	1800KAIW21MPN	95
	G 3/4		1800 EC	1800KAIW26MPN	95
Hose Barb	10 mm	32KATF10MPN	1800 EK10	1800KATF10MPN	95
	13 mm	32KATF13MPN	1800 EK12	1800KATF13MPN	95
	16 mm	32KATF16MPN	1800 EK16	1800KATF16MPN	95
	19 mm	32KATF19MPN	1800 EK19	1800KATF19MPN	95
 Plugs – without valve					
Male Thread	R 1/8		18105	1800SFAK10SXZ	95
	R 1/4	32SFAK13SXZ	18110 A	1800SFAK13SXZ	95
	G 1/4		18110	1800SFAW13SXZ	95
	R 3/8	32SFAK17SXZ	18210 A	1800SFAK17SXZ	95
	G 3/8		18210	1800SFAW17SXZ	95
	R 1/2	32SFAK21SXZ	18220	1800SFAK21SXZ	95
	R 3/4		18230	1800SFAK26SXZ	95
Female Thread	G 1/4	32SFIW13SXZ	18405	1800SFIW13SXZ	95
	G 3/8	32SFIW17SXZ	18410	1800SFIW17SXZ	95
	G 1/2	32SFIW21SXZ	18420	1800SFIW21SXZ	95
Hose Barb	6 mm	32SFTF06SXZ	18006	1800SFTF06SXZ	95
	8 mm	32SFTF08SXZ	18008	1800SFTF08SXZ	95
	10 mm	32SFTF10SXZ	18010	1800SFTF10SXZ	95
	12 mm		18012	1800SFTF12SXZ	95
	16 mm	32SFTF16SXZ	18016	1800SFTF16SXZ	95
	19 mm	32SFTF19SXZ	18019	1800SFTF19SXZ	95

Cross-Reference-List

Connection	Thread	Rectus Part Number old	Tema Part Number old	Part Number new	Page
 Couplings – with valve					
Male Thread	G 1/2		1800 NA	1800KBAW21MPN	96
Female Thread	G 3/8		1800 N	1800KBIW17MPN	96
	G 1/2		1800 NB	1800KBIW21MPN	96
	G 3/4		1800 NC	1800KBIW26MPN	96
 Plugs – with valve					
Male Thread	1/2 - 14NPTF		18420 MN	1800SBAN21MPC	96
Female Thread	G 3/8		18410 MN	1800SBIW17MPC	96
	G 3/4		18430 MN	1800SBIW26MPC	96

10 = 80 mm²**34**

Industrial coupling with Atlas Copco-Profile. Coupling system with single-hand operation. High Flow valve for optimum flow and low pressure drop. Optimal for use with large pneumatic consumers due to the robust design and steel sleeve. The collar design minimises damage to the valve body.

Series 34 with additional end connections available on request.

Dust Protections  (P. 250)
for Coupling Part.-No. SK27S

Working Temperature*
-20°C up to +100°C (NBR)
depending on the medium.

* For temperatures below -20°C and over +100°C and depending on the medium, other seal variants (FKM, EPDM, FFKM) are available.

**Working Pressure****

35 bar

** maximum static working pressure with design factor 4 to 1.

Material

Coupling: Brass / Steel nickel plated

Plug: Steel nickel plated

Seals: NBR

Technical Description

Connecting Force 0 bar: 80 N

Connecting Force 6 bar: 200 N

Vacuum Coupling: 96%

Vacuum connected: 96%

Interchangeability (KA only)

- Atlas Copco QIC 15

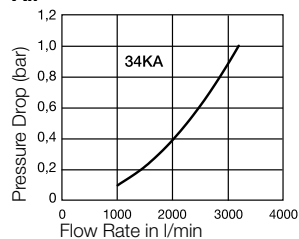
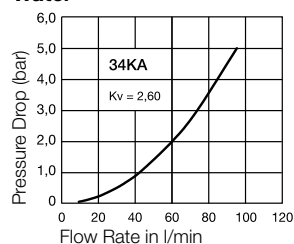
Flow diagrams**Air****Water**



Couplings – with valve

Series 34KA

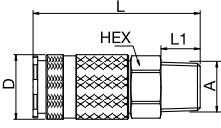
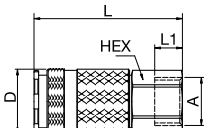
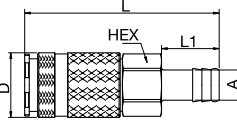
	Connection A	HEX mm	L mm	L1 mm	D mm	Part Number
 Male Thread	R 3/8	24	70	12	28	34KAAK17SPN
	R 1/2	24	72	12	28	34KAAK21SPN
	R 3/4	27	72	12	28	34KAAK26SPN
 Female Thread	G 3/8	24	64	12	28	34KAIW17SPN
	G 1/2	24	64	12	28	34KAIW21SPN
 Hose Barb	10 mm	24	84	25	28	34KATF10SPN
	13 mm	24	84	25	28	34KATF13SPN
	16 mm	24	84	25	28	34KATF16SPN
	19 mm	24	84	25	28	34KATF19SPN



Plugs – without valve

Series 34KA

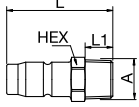
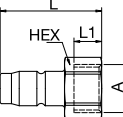
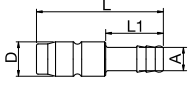
	Connection A	HEX mm	L mm	L1 mm	D mm	Part Number
 Male Thread	R 1/4	17	46	12		34SFAK13SXN
	R 3/8	19	46	12		34SFAK17SXN
	R 1/2	22	52	17		34SFAK21SXN
 Female Thread	G 3/8	19	40	9		34SFIW17SXN
	G 1/2	24	44	12		34SFIW21SXN
 Hose Barb	10 mm		55	25	15	34SFTF10SXN
	13 mm		55	25	15	34SFTF13SXN

Nominal Diameter

10 = 80 mm²

Rectus Series

41

Brass coupling with no valve for applications with liquids in the pressure range up to 35 bar. The couplings are corrosion resistant. The system stands out for a high flow with minimal pressure drop.

Series 41 with additional end connections available on request.

Working Temperature*

-20°C up to +100°C (NBR)
depending on the medium.

* For temperatures below -20°C and over +100°C and depending on the medium, other seal variants (FKM, EPDM, FFKM) are available.

**Working Pressure****

35 bar

** maximum static working pressure with design factor 4 to 1.

Material

Coupling: Brass nickel plated

Plug: Brass nickel plated

Seals: NBR

Technical Description

Connecting Force 0 bar: 10 N

Connecting Force 6 bar: 10 N

Interchangeability (KA only)

- Rectus 27
- Cejn 417

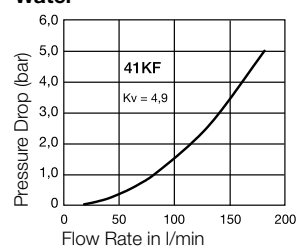
Flow diagrams**Water**

Couplings – without valve **Series 41KF**

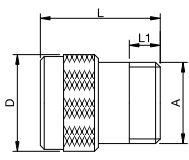
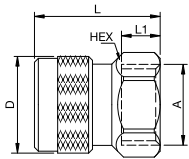
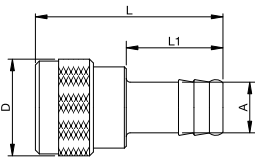
	Connection A	HEX mm	L mm	L1 mm	D mm	Part Number
 <p>Male Thread</p>	G 1/2		31	8	25	41KFAW21MPN
 <p>Female Thread</p>	G 1/2	24	32,5	10	25	41KFIW21MPN
 <p>Hose Barb</p>	13 mm		48,5	25	25	41KFTF13MPN

Plugs – without valve **Series 41KF**

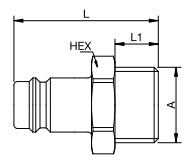
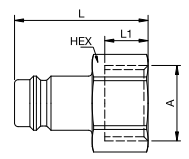
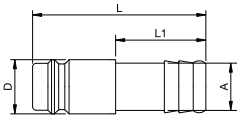
	Connection A	HEX mm	L mm	L1 mm	D mm	Part Number
 <p>Male Thread</p>	G 1/2	24	40	12		41SFAW21MXN
 <p>Female Thread</p>	G 1/2	24	37	12		41SFIW21MXN
 <p>Hose Barb</p>	13 mm		48	25	15	41SFTF13MXN
	16 mm		49	25	18	41SFTF16MXN
	19 mm		49	25	21	41SFTF19MXN

Nominal Diameter

11 = 95 mm²

Rectus Series

42

Brass coupling with no valve for applications with liquids in the pressure range up to 35 bar. The couplings are corrosion resistant. The system stands out for a high flow with minimal pressure drop.

Series 42 with additional end connections available on request.

Working Temperature*

-20°C up to +100°C (NBR)
depending on the medium.

* For temperatures below -20°C and over +100°C and depending on the medium, other seal variants (FKM, EPDM, FFKM) are available.

**Working Pressure****

35 bar

** maximum static working pressure with design factor 4 to 1.

Material

Coupling: Brass chrome plated

Plug: Brass chrome plated

Seals: NBR

Technical Description

Connecting Force 0 bar: 15 N

Connecting Force 6 bar: 15 N

Interchangeability (KA only)

- ABA-Beul

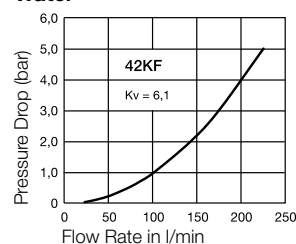
Flow diagrams**Water**

Couplings – without valve **Series 42KF**

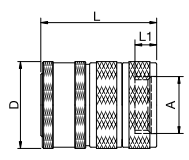
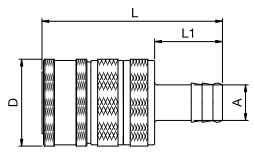
	Connection A	HEX mm	L mm	L1 mm	D mm	Part Number
 <p>Female Thread</p>	G 1/2		34	8	32	42KFIW21MPC
	G 3/4		34	8	32	42KFIW26MPC
 <p>Hose Barb</p>	9 mm		55	25	32	42KFTF09MPC

Plugs – without valve **Series 42KF**

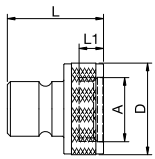
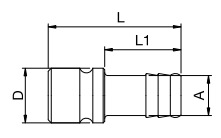
	Connection A	HEX mm	L mm	L1 mm	D mm	Part Number
 <p>Female Thread</p>	G 1/2		31,5	8	30	42SFIW21MXC
	G 3/4		31,5	8	30	42SFIW26MXC
 <p>Hose Barb</p>	13 mm		48	25	15	42SFTF13MXC

11 = 95 mm²**37**

Robust brass coupling system 1/2" according to ISO 6150 B and US MIL-SPEC 4109. Coupling system with single-hand operation. The high insertion depth is guaranteed by an optimised plug guide.

Series 37 with additional end connections available on request.

Dust Protections  (P. 250)
for Coupling Part.-No. SK27S
for Plug Part.-No. SK16S

Working Temperature*
-20°C up to +100°C (NBR)
depending on the medium.

* For temperatures below -20°C and over +100°C and depending on the medium, other seal variants (FKM, EPDM, FFKM) are available.

**Working Pressure****

35 bar

** maximum static working pressure with design factor 4 to 1.

Material

Coupling: Brass
Plug: Steel nickel plated
Seals: NBR

Technical Description

Connecting Force 0 bar: 85 N
Connecting Force 6 bar: 185 N

Vacuum Coupling: 96%
Vacuum connected: 96%

Interchangeability (KA only)

- Industrial Interchange 1/2"
- US-MIL-SPEC C-4109 1/2"
- ISO 6150-B
- Gromelle 1300
- Hansen 5000

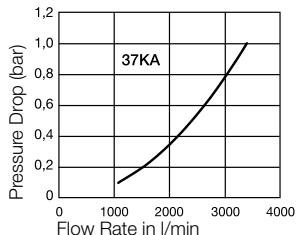
Flow diagrams**Air**



Couplings – with valve

Series 37KA

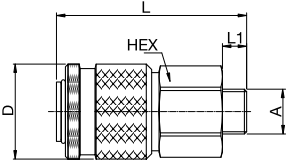
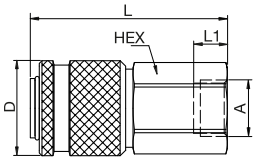
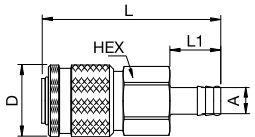
	Connection A	HEX mm	L mm	L1 mm	D mm	Version	Part Number
 <p>Male Thread</p>	G 1/2	30	76,5	12	35	blank	37KAAW21MPX
	G 1/2	30	76,5	12	35	nickel plated	37KAAW21MPN
	G 3/4	30	77,5	13	35	blank	37KAAW26MPX
 <p>Female Thread</p>	G 1/2	30	73	10	35	blank	37KAIW21MPX
 <p>Hose Barb</p>	13 mm	30	86	25	35	blank	37KATF13MPX
	19 mm	30	86	25	35	blank	37KATF19MPX



Plugs – without valve

Series 37KA

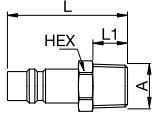
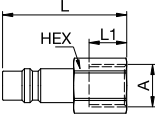
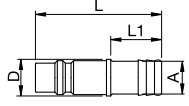
	Connection A	HEX mm	L mm	L1 mm	D mm	Version	Part Number
 <p>Male Thread</p>	R 1/2	22	60	17			37SFAK21SXN
	R 3/4	27	61	19			37SFAK26SXN
 <p>Female Thread</p>	G 1/2	24	50	10			37SFIW21SXN
 <p>Hose Barb</p>	10 mm		62	25	17		37SFTF10SXN
	13 mm		62	25	17		37SFTF13SXN
	16 mm		62	25	18		37SFTF16SXN
	19 mm		72	35	21		37SFTF19SXN

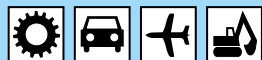

German industrial profile for compressed air applications. High Flow valve for optimum flow and low pressure drop. Robust structure, optimised with respect to size and performance. Especially suitable for oscillating forces due to steel sleeve and steel valve bodies. The collar design minimises damage to the valve body.

Working Temperature*

-20°C up to +100°C (NBR) depending on the medium.

* For temperatures below -20°C and over +100°C and depending on the medium, other seal variants (FKM, EPDM, FFKM) are available.

Series 57 with additional end connections available on request.



Working Pressure**

35 bar
** maximum static working pressure with design factor 4 to 1.

35 bar

Features

- Brass design particularly suited to use with liquids

Material

Coupling: Brass nickel plated
Plug: Steel nickel plated
Seals: NBR

Coupling: Brass nickel plated
Plug: Brass nickel plated
Seals: NBR

Technical Description

Connecting Force 0 bar: 150 N
Connecting Force 6 bar: 350 N

Dead space volume: 16 ml

Vacuum Coupling: 87%
Vacuum connected: 87%

Connecting Force 0 bar: 150 N
Connecting Force 6 bar: 350 N

Vacuum Coupling: 96%
Vacuum Plug: 96%
Vacuum connected: 96%

Interchangeability (KA only)

- Walther LP012

Flow diagrams

Air

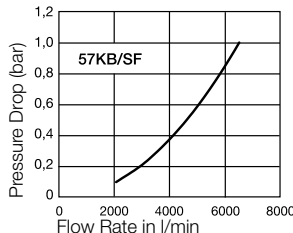

Air

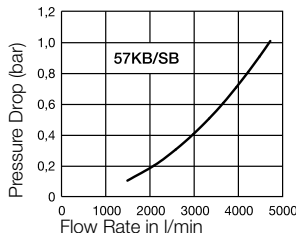

Water

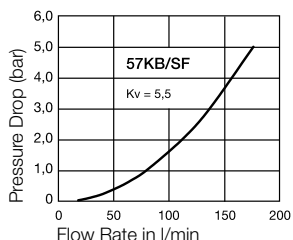

Water

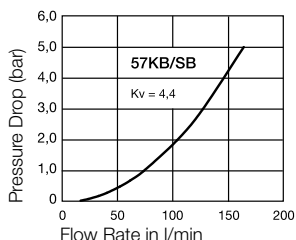

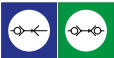

Couplings – with valve

Series 57KB

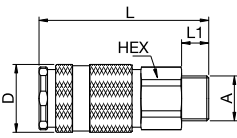
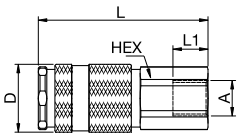
	Connection A	HEX mm	L mm	L1 mm	D mm	Part Number
 <p>Male Thread</p>	G 1/2	34	98	12	40	57KBAW21BPN
	G 3/4	34	100	16	40	57KBAW26BPN
 <p>Female Thread</p>	G 1/2	34	100	19	40	57KBIW21BPN
	G 3/4	34	100	16	40	57KBIW26BPN



Plugs – without valve

Series 57SF

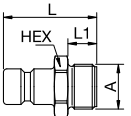
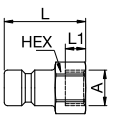
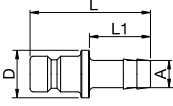
	Connection A	HEX mm	L mm	L1 mm	D mm	Part Number	
 <p>Male Thread</p>	G 1/2	27	52	15		57SFAW21SXN	
 <p>Female Thread</p>	G 1/2	27	48	15		57SFIW21SXN	
	G 3/4	32	54	20		57SFIW26SXN	
 <p>Hose Barb</p>	16 mm		71	36	28	57SFTF16SXN	
	19 mm		71	36	28	57SFTF19SXN	



Plugs – with valve

Series 57SB

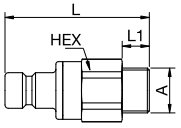
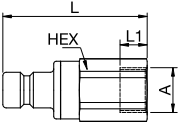
	Connection A	HEX mm	L mm	L1 mm	D mm	Part Number
 <p>Male Thread</p>	G 1/2	34	83	12		57SBAW21MPN
	G 3/4	34	85	16		57SBAW26MPN
 <p>Female Thread</p>	G 1/2	34	85	19		57SBIW21MPN
	G 3/4	34	85	16		57SBIW26MPN

Nominal Diameter

12,4 = 120 mm²

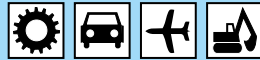

Tema Series

1900

Low Pressure



Robust, corrosion resistant coupling system in brass with high flow values for use with liquids in the pressure range up to 50 bar.

Two-hand operation, i.e. both hands are required when connect/disconnect. The main seal of the coupling has a special disc shape, which extends the durability of the coupling. To guarantee greater flexibility, we also offer plugs with no valve.

Working Temperature*

-40°C up to +150°C (EPDM) depending on the medium.

* For temperatures below -40°C and over +150°C and depending on the medium, other seal variants (NBR, FKM, FFKM) are available.

Series 1900 with additional end connections available on request.



Working Pressure**

50 bar
** maximum static working pressure with design factor 4 to 1.

50 bar

Material

Coupling: Brass nickel plated and chrome plated
Plug: Brass nickel plated and chrome plated
Seals: EPDM

Coupling: Brass nickel plated and chrome plated
Plug: Brass nickel plated and chrome plated
Seals: EPDM

Interchangeability (KA only)

- Tema Design

Flow diagrams

Air

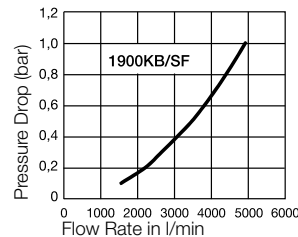

Water

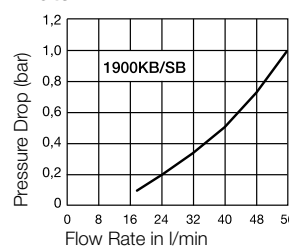

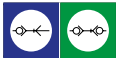

Couplings – with valve

Series 1900KB

	Connection A	HEX mm	L mm	L1 mm	D mm	Part Number
<p>Female Thread</p>	G 1/2	27	67	12	33	1900KBIW21MEN
	G 3/4	30	68	12	33	1900KBIW26MEN



Plugs – without valve

Series 1900SF

	Connection A	HEX mm	L mm	L1 mm	D mm	Part Number
<p>Female Thread</p>	G 1/2	27	60	12		1900SFIW21MXC
	G 3/4	30	62	12		1900SFIW26MXC







Plugs – with valve

Series 1900SB

	Connection A	HEX mm	L mm	L1 mm	D mm	Part Number
<p>Female Thread</p>	G 1/2	27	60	12		1900SBIW21MEC
	G 3/4	30	62	12		1900SBIW26MEC

Cross-Reference-List

Connection	Thread	Rectus Part Number old	Tema Part Number old	Part Number new	Page
  Couplings – with valve					
Female Thread	G 1/2		1900 NBE	1900KBIW21MEN	113
	G 3/4		1900 NCE	1900KBIW26MEN	113
 Plugs – without valve					
Female Thread	G 1/2		19420 M	1900SFIW21MXC	113
	G 3/4		19430 M	1900SFIW26MXC	113
 Plugs – with valve					
Female Thread	G 1/2		19420 MNE	1900SBIW21MEC	113
	G 3/4		19430 MNE	1900SBIW26MEC	113

Nominal Diameter

13 = 130 mm²

Rectus Series

29

Robust coupling system in steel, which is particularly suited to use in the construction industry and mining. Coupling system with single-hand operation. High Flow valve for optimum flow and low pressure drop.

Series 29 with additional end connections available on request.

Working Temperature*

-20°C up to +100°C (NBR)
depending on the medium.

* For temperatures below -20°C and over +100°C and depending on the medium, other seal variants (FKM, EPDM, FFKM) are available.

**Working Pressure****

35 bar

** maximum static working pressure with design factor 4 to 1.

Material

Coupling: Steel zinc plated

Plug: Steel zinc plated

Seals: NBR

Technical Description

Connecting Force 0 bar: 100 N

Connecting Force 6 bar: 400 N

Vacuum Coupling: 96%

Vacuum connected: 96%

Interchangeability (KA only)

- Rectus Design

Flow diagrams

Air

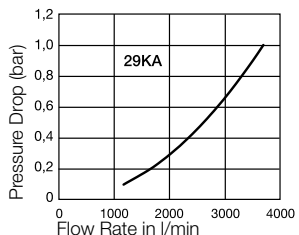



Couplings – with valve

Series 29KA

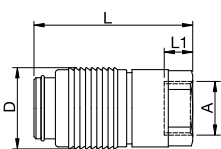
	Connection A	HEX mm	L mm	L1 mm	D mm	Part Number
 <p>Female Thread</p>	G 1/2		78	13	40	29KAIW21SPZ
	G 3/4		78	16	40	29KAIW26SPZ



Plugs – without valve

Series 29KA

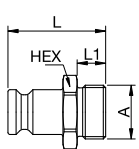
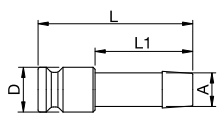
	Connection A	HEX mm	L mm	L1 mm	D mm	Part Number
 <p>Male Thread</p>	G 1/2	24	48	13		29SFAW21SPZ
 <p>Hose Barb</p>	13 mm		76	49	22	29SFTF13SPZ



Compact industrial coupling system in brass for use with numerous gaseous and liquid media. High Flow valve for optimum flow and low pressure drop.

Series 38 in brass material with nickel plating and with additional end connections available on request.

Working Temperature*
-20°C up to +100°C (NBR) depending on the medium.

* For temperatures below -20°C and over +100°C and depending on the medium, other seal variants (FKM, EPDM, FFKM) are available.



Working Pressure**

35 bar
** maximum static working pressure with design factor 4 to 1.

35 bar

Material

Coupling: Brass
Plug: Brass
Seals: NBR

Coupling: Brass
Plug: Brass
Seals: NBR

Technical Description

Connecting Force 0 bar: 80 N
Connecting Force 6 bar: 340 N

Vacuum Coupling: 70%
Vacuum connected: 87%

Dead space volume: 8,5 ml

Connecting Force 0 bar: 90 N
Connecting Force 6 bar: 350 N

Vacuum Coupling: 96%
Vacuum Plug: 96%
Vacuum connected: 96%

Interchangeability (KA only)

- Hansen 6000

Flow diagrams

Air

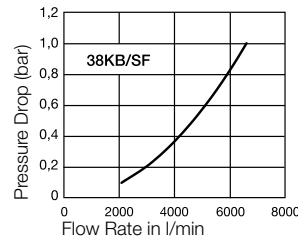

Air

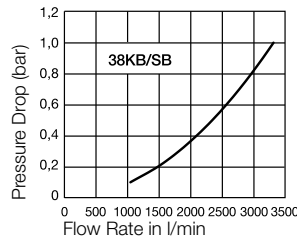

Water

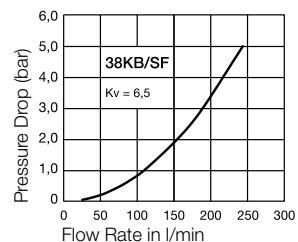

Water

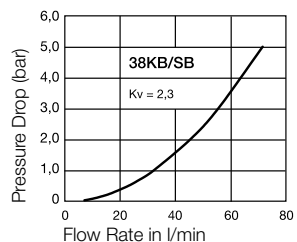

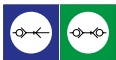

Couplings – with valve

Series 38KB

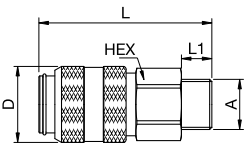
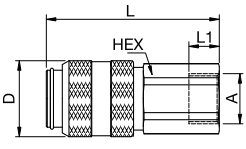
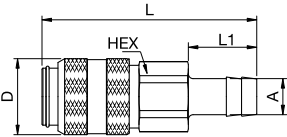
	Connection A	HEX mm	L mm	L1 mm	D mm	Part Number
 <p>Male Thread</p>	G 1/2	34	89	12	40	38KBAW21MPX
	G 3/4	34	91	16	40	38KBAW26MPX
 <p>Female Thread</p>	G 1/2	34	95	20	40	38KBIW21MPX
	G 3/4	34	91	14	40	38KBIW26MPX
 <p>Hose Barb</p>	13 mm	34	105	28	40	38KBTf13MPX
	19 mm	34	113	36	40	38KBTf19MPX



Plugs – without valve

Series 38SF

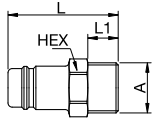
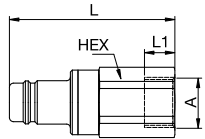
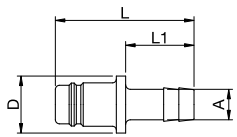
	Connection A	HEX mm	L mm	L1 mm	D mm	Part Number
 <p>Male Thread</p>	G 1/2	24	54	12		38SFAW21MXX
	G 3/4	27	58	16		38SFAW26MXX
	G 1	36	63	19		38SFAW33MXX
 <p>Female Thread</p>	G 1/2	24	49	12		38SFIW21MXX
	G 3/4	30	54	18		38SFIW26MXX
	G 1	41	61	24		38SFIW33MXX
 <p>Hose Barb</p>	13 mm		65	28	30	38SFTF13MXX
	19 mm		73	36	30	38SFTF19MXX



Plugs – with valve

Series 38SB

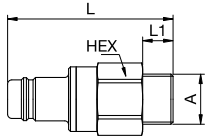
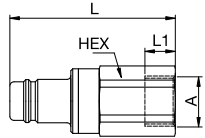
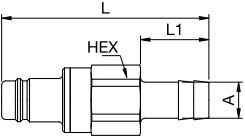
	Connection A	HEX mm	L mm	L1 mm	D mm	Part Number
 <p>Male Thread</p>	G 1/2	34	85	12		38SBAW21MPX
	G 3/4	34	87	16		38SBAW26MPX
 <p>Female Thread</p>	G 1/2	34	87	16		38SBIW21MPX
	G 3/4	34	87	16		38SBIW26MPX
 <p>Hose Barb</p>	13 mm	34	103	28		38SBTF13MPX
	19 mm	34	109	36		38SBTF19MPX



Compact industrial coupling system in brass for use with numerous gaseous and liquid media. High Flow valve for optimum flow and low pressure drop.

Series 39 in brass material without nickel plating and with additional end connections available on request.

Working Temperature*

-20°C up to +100°C (NBR) depending on the medium.

* For temperatures below -20°C and over +100°C and depending on the medium, other seal variants (FKM, EPDM, FFKM) are available.

**Working Pressure****

35 bar

** maximum static working pressure with design factor 4 to 1.

Features**Material**

Coupling: Brass nickel plated
Plug: Brass
Seals: NBR

Technical Description

Connecting Force 0 bar: 120 N
Connecting Force 6 bar: 460 N

Vacuum Coupling: 60%



35 bar

Coupling: Brass nickel plated
Plug: Brass nickel plated
Seals: NBR

Dead space volume: 14,5 ml

Connecting Force 0 bar: 100 N
Connecting Force 6 bar: 450 N

Vacuum Coupling: 60%



8 bar

Coupling: Brass nickel plated
Plug: Brass nickel plated
Seals: NBR

Connecting Force 0 bar: 100 N
Connecting Force 6 bar: 450 N

Vacuum Coupling: 96%
Vacuum connected: 96%

- Minimal, almost imperceptible leakage when uncoupling
- No air locked into the system during the coupling process

Interchangeability (KA only)

- Hansen 7000

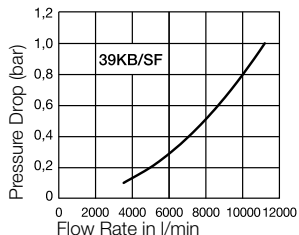
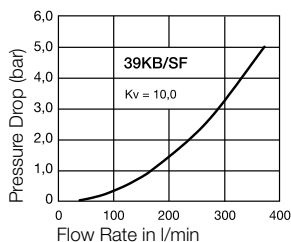
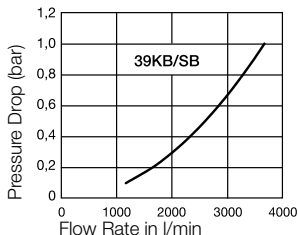
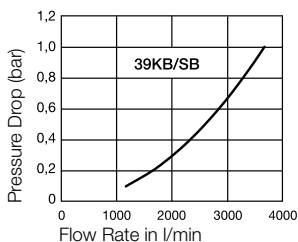
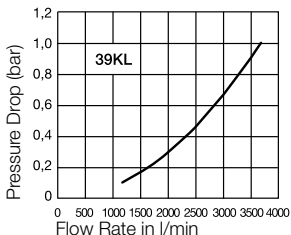
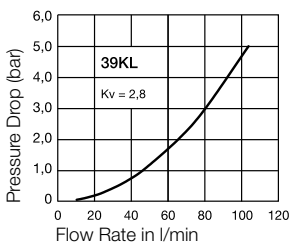
Flow diagrams**Air****Water****Air****Water****Air****Water**



Couplings – with valve

Series 39KB

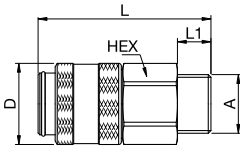
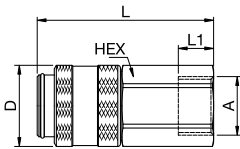
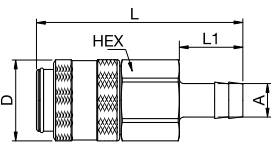
	Connection A	HEX mm	L mm	L1 mm	D mm	Version	Part Number
 <p>Male Thread</p>	G 1	41	98	19	46		39KBAW33MPN
 <p>Female Thread</p>	G 1	41	100	20	46		39KBIW33MPN
 <p>Hose Barb</p>	25 mm	41	125	48	46		39KBTf25MPN



Plugs – without valve

Series 39SF

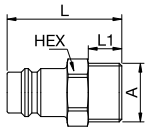
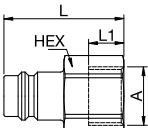
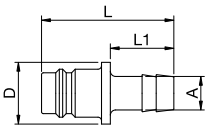
	Connection A	HEX mm	L mm	L1 mm	D mm	Version	Part Number
 <p>Male Thread</p>	G 3/4	30	60	16		blank	39SFAW26MXX
	G 1	34	65	19		nickel plated	39SFAW33MXN
 <p>Female Thread</p>	G 1	41	68	24		nickel plated	39SFIW33MXN
 <p>Hose Barb</p>	19 mm		75	36	35	nickel plated	39SFTF19MXN



Plugs – with valve

Series 39SB

	Connection A	HEX mm	L mm	L1 mm	D mm	Version	Part Number
<p>Male Thread</p>	G 1	41	95	19			39SBAW33MPN
<p>Female Thread</p>	G 1	41	97	24			39SBIW33MPN
<p>Hose Barb</p>	25 mm	41	124	48			39SBTF25MPN



Couplings – flat sealing

Series 39KL

	Connection A	HEX mm	L mm	L1 mm	D mm	Version	Part Number
<p>Male Thread</p>	G 1	41	98	19	46		39KLAW33MPN
<p>Female Thread</p>	G 1	41	100	20	46		39KLIW33MPN



Plugs – flat sealing

Series 39KL

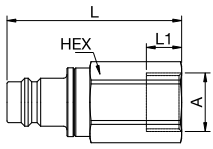
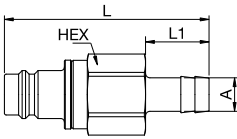
	Connection A	HEX mm	L mm	L1 mm	D mm	Version	Part Number
 <p>Female Thread</p>	G 1	41	97	24			39SLIW33MPN
 <p>Hose Barb</p>	19 mm	41	114	36			39SLTF19MPN

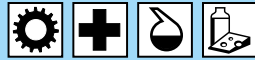

Coupling series in sizes 1/8" to 1" with plug profile compliant with ISO 7241-1 series B. Particularly suited to use with liquid media.

Coupling system with two-hand operation, i.e. both hands are required when coupling/uncoupling. The coupling series stands out for its high flow rates against a low pressure drop.

Series 70 with additional end connections available on request.

Working Temperature*

-20°C up to +100°C (NBR) depending on the medium.

* For temperatures below -20°C and over +100°C and depending on the medium, other seal variants (FKM, EPDM, FFKM) are available.

**Working Pressure****

see chart

** maximum static working pressure with design factor 4 to 1.

Material

Coupling: Brass

Plug: Brass

Seals: NBR

Technical Description

Dead space volume: 0,45 ml

Connecting Force 0 bar: 55 N

Connecting Force 6 bar: 140 N

Vacuum Coupling: 96% *

Vacuum Plug: 96% *

Vacuum connected: 96% *

* Except for series 76, which is not suitable for vacuum applications.

Other designs in series 70

The following other designs can be found from page:

- ▶ Stainless Steel P. 164
- ▶ Thermoplastic P. 190

Interchangeability

- ISO 7241-1 Series B

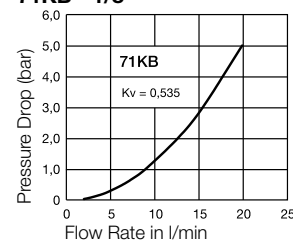
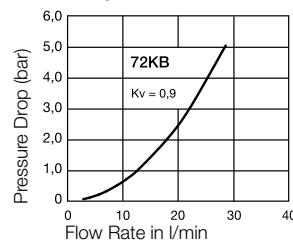
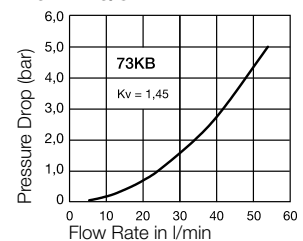
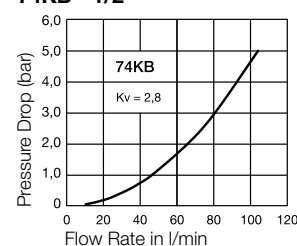
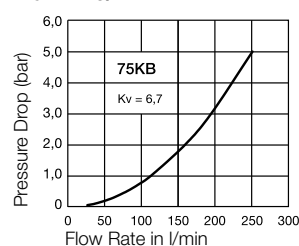
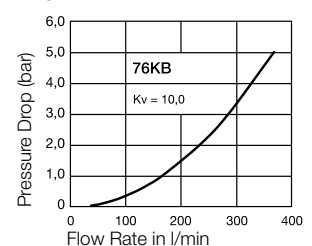
Flow diagrams Water**71KB - 1/8"****72KB - 1/4"****73KB - 3/8"****74KB - 1/2"****75KB - 3/4"****76KB - 1"**



Couplings – with valve

Series 70KB

Size	Connection A	HEX mm	HEX1 mm	L mm	L1 mm	D mm	Version	Working Pressure max. / bar	Part Number
1/8"	G 1/8	14		48,5	7	25	blank	250	71KBIW10MPX
1/8"	G 1/8	14		48,5	7	25	nickel plated	250	71KBIW10MPN
1/4"	G 1/4	19		57,5	10	25	blank	200	72KBIW13MPX
1/4"	G 1/4	19		57,5	10	25	nickel plated	200	72KBIW13MPN
3/8"	G 3/8	22		64	11,5	35	blank	200	73KBIW17MPX
3/8"	G 3/8	22		64	11,5	35	nickel plated	200	73KBIW17MPN
1/2"	G 1/2	27		76	16	44,5	blank	150	74KBIW21MPX
1/2"	G 1/2	27		76	16	44,5	nickel plated	150	74KBIW21MPN
3/4"	G 3/4	34		96	24	55	blank	100	75KBIW26MPX
3/4"	G 3/4	34		96	24	55	nickel plated	100	75KBIW26MPN
1"	G 1	41		105,5	24	62	blank	100	76KBIW33MPX
1"	G 1	41		105,5	24	62	nickel plated	100	76KBIW33MPN

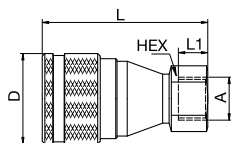

Female Thread



Plugs – with valve

Series 70KB

Size	Connection A	HEX mm	HEX1 mm	L mm	L1 mm	D mm	Version	Working Pressure max. / bar	Part Number
1/8"	G 1/8	14		29,5	7		blank	250	71SBIW10MPX
1/8"	G 1/8	14		29,5	7		nickel plated	250	71SBIW10MPN
1/4"	G 1/4	19		35	10		blank	200	72SBIW13MPX
1/4"	G 1/4	19		35	10		nickel plated	200	72SBIW13MPN
3/8"	G 3/8	22		39	11,5		blank	200	73SBIW17MPX
3/8"	G 3/8	22		39	11,5		nickel plated	200	73SBIW17MPN
1/2"	G 1/2	27		48	16		blank	150	74SBIW21MPX
1/2"	G 1/2	27		48	16		nickel plated	150	74SBIW21MPN
3/4"	G 3/4	36		60	24		blank	100	75SBIW26MPX
3/4"	G 3/4	36		60	24		nickel plated	100	75SBIW26MPN
1"	G 1	41		65	24		blank	100	76SBIW33MPX
1"	G 1	41		65	24		nickel plated	100	76SBIW33MPN

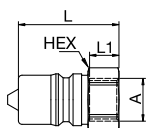

Female Thread

Nominal Diameter

22 = 380 mm²

Tema Series

2100

Series 2100 is used mainly in the area of compressed air. The system is particularly suited to large pneumatic plants and compressed air tools with a very high flow. This series has a special safety function, which requires a turn and push/pull movement during connection and disconnection. It also has an automatic pressure release function, which facilitates easy handling. A coupling system with very high flow rates, robust design, high corrosion resistance and a safety function. Ultra High Flow valve for optimum flow and low pressure drop.

Series 2100 with additional end connections available on request.

**Working Pressure****

20 bar

** maximum static working pressure with design factor 4 to 1.

Material

Coupling: Brass / Steel hardened, zinc plated and passivated

Plug: Steel hardened, zinc plated and passivated

Seals: NBR

Dust Protections (P. 250)
for Coupling Part.-No. 10026
for Plug Part.-No. 5026-QC

Working Temperature*

-20°C up to +100°C (NBR)
depending on the medium.

* For temperatures below -20°C and over +100°C and depending on the medium, other seal variants (FKM, EPDM, FFKM) are available.

Interchangeability (KA only)

- Tema Design

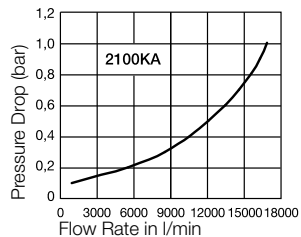
Flow diagrams**Air**



Couplings – with valve

Series 2100KA

	Connection A	HEX mm	L mm	L1 mm	D mm	Part Number
<p>Female Thread</p>	G 1	41	82	14	48	2100KAIW33MPX





Plugs – without valve

Series 2100KA

	Connection A	HEX mm	L mm	L1 mm	D mm	Part Number
<p>Male Thread</p>	G 1	36	57	14		2100SFAW33SXZ
<p>Hose Barb</p>	19 mm		74	36		2100SFTF19SXZ
	25 mm		40	36		2100SFTF25SXZ

Cross-Reference-List

Connection	Thread	Rectus Part Number old	Tema Part Number old	Part Number new	Page
 Couplings – with valve					
Female Thread	G 1		2100	2100KAIW33MPX	129
 Plugs – without valve					
Male Thread	G 1		21210	2100SFAW33SXZ	129
Hose Barb	19 mm		21019-QC	2100SFTF19SXZ	129
	25 mm		21025	2100SFTF25SXZ	129

Nominal Diameter

2,7 = 5 mm²



Rectus Series

20

Low Pressure



Other designs in series 20

The following other designs can be found from page:

► Brass / Steel P. 18

Mini industrial coupling with internationally used profile. Frequent use in medical technology and chemistry/pharmacy. Coupling system with single-hand operation. High flow despite small dimensions plus many applications with a variety of media.

Series 20 with additional end connections available on request.

Working Temperature*

-15°C up to +200°C (FKM) depending on the medium.

* For temperatures below -15°C and over +200°C and depending on the medium, other seal variants (EPDM, FFKM) are available.



Working Pressure**

35 bar
** maximum static working pressure with design factor 4 to 1.

35 bar

Features

- Low pressure drop

Material

Coupling: AISI 303 / AISI 316 L
Plug: AISI 303 / AISI 316 L
Seals: FKM

Coupling: AISI 303 / AISI 316 L
Plug: AISI 303 / AISI 316 L
Seals: FKM

Technical Description

Connecting Force 0 bar: 25 N
Connecting Force 6 bar: 35 N

Connecting Force 0 bar: 25 N
Connecting Force 6 bar: 35 N

Vacuum Coupling: 96%
Vacuum connected: 96%

Vacuum Coupling: 96%
Vacuum Plug: 96%
Vacuum connected: 96%

Interchangeability (KA only)

- Walther 06-003

Flow diagrams

Air

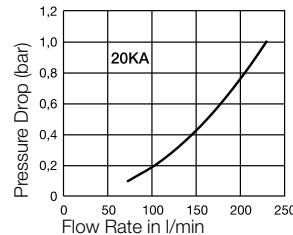

Air

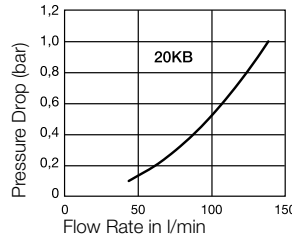

Water

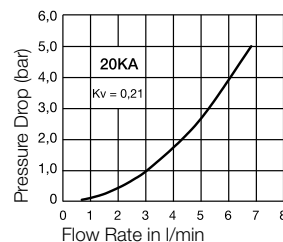

Water

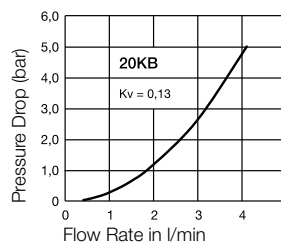



Couplings – with valve

Series 20KA

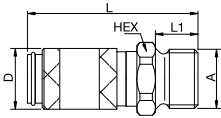
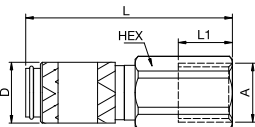
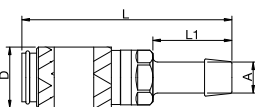
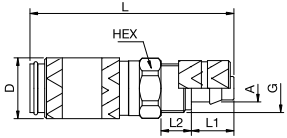
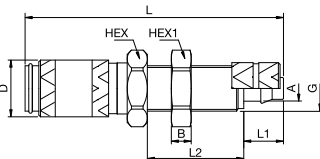
	Connection A	HEX mm	HEX1 mm	L mm	L1 mm	L2 mm	D mm	B mm	G mm	Version	Part Number
 <p>Male Thread</p>	M 5	9		26	5		10			AISI 303	20KAAM05RVX
	M 5	9		26	5		10			AISI 316 L	20KAAM05EVX
	G 1/8	11		28	7		10			AISI 303	20KAAW10RVX
	G 1/8	11		28	7		10			AISI 316 L	20KAAW10EVX
 <p>Female Thread</p>	G 1/8	12		28	7		10			AISI 303	20KAIW10RVX
	G 1/8	12		28	7		10			AISI 316 L	20KAIW10EVX
 <p>Hose Barb</p>	4 mm			35	13		10			AISI 316 L	20KATF04EVX
 <p>with Plastic Hose Connection</p>	3 x 4 mm	9		34	7	5	10		M 7 x 0,5	AISI 316 L	20KAKO04EVX
	3 x 5 mm	9		34	7	5	10		M 7 x 0,5	AISI 316 L	20KAKO05EVX
	4 x 6 mm	9		34	7	5	10		M 8 x 0,5	AISI 303	20KAKO06RVX
	4 x 6 mm	9		34	7	5	10		M 8 x 0,5	AISI 316 L	20KAKO06EVX
 <p>Panel Mount with Plastic Hose Connection</p>	3 x 4 mm	12	11	45	7	17	10	3	M 7 x 0,5	AISI 303	20KAKS04RVX
	3 x 5 mm	12	11	45	7	17	10	3	M 7 x 0,5	AISI 303	20KAKS05RVX
	4 x 6 mm	12	11	45	7	17	10	3	M 8 x 0,5	AISI 303	20KAKS06RVX



Plugs – without valve

Series 20KA

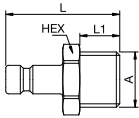
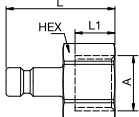
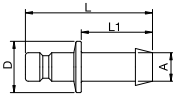
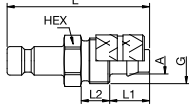
	Connection A	HEX mm	HEX1 mm	L mm	L1 mm	L2 mm	D mm	B mm	G mm	Version	Part Number
 <p>Male Thread</p>	M 5	7		18	5					AISI 303	20SFAM05RXX
	M 5	7		18	5					AISI 316 L	20SFAM05EXX
	G 1/8	11		20	7					AISI 303	20SFAW10RXX
	G 1/8	11		20	7					AISI 316 L	20SFAW10EXX
 <p>Female Thread</p>	G 1/8	12		19	7					AISI 303	20SFIW10RXX
	G 1/8	12		19	7					AISI 316 L	20SFIW10EXX
 <p>Hose Barb</p>	4 mm			24	13		7			AISI 303	20SFTF04RXX
	4 mm			24	13		7			AISI 316 L	20SFTF04EXX
	5 mm			22	13		9			AISI 303	20SFTF05RXX
 <p>with Plastic Hose Connection</p>	3 x 4 mm	8		25	7	5			M 7 x 0,5	AISI 316 L	20SFKO04EXX
	3 x 5 mm	8		25	7	5			M 7 x 0,5	AISI 316 L	20SFKO05EXX
	4 x 6 mm	8		25	7	5			M 8 x 0,5	AISI 303	20SFKO06RXX
	4 x 6 mm	8		25	7	5			M 8 x 0,5	AISI 316 L	20SFKO06EXX

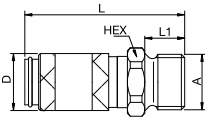
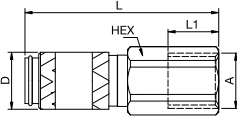
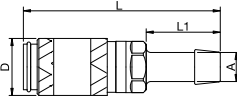
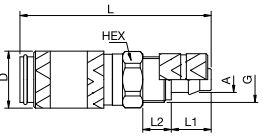
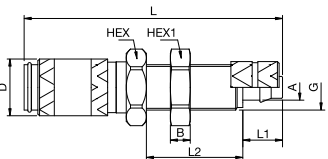

	Connection A	HEX mm	HEX1 mm	L mm	L1 mm	L2 mm	D mm	B mm	G mm	Version	Part Number
 <p>Male Thread</p>	M 5	9		26	5		10			AISI 303	20KBAM05RVX
	M 5	9		26	5		10			AISI 316 L	20KBAM05EVX
	G 1/8	11		28	7		10			AISI 303	20KBAW10RVX
	G 1/8	11		28	7		10			AISI 316 L	20KBAW10EVX
 <p>Female Thread</p>	G 1/8	12		28	7		10			AISI 303	20KBIW10RVX
	G 1/8	12		28	7		10			AISI 316 L	20KBIW10EVX
 <p>Hose Barb</p>	4 mm			35	13		10			AISI 316 L	20KBTf04EVX
 <p>with Plastic Hose Connection</p>	3 x 4 mm	9		34	7	5	10		M 7 x 0,5	AISI 316 L	20KBKO04EVX
	3 x 5 mm	9		34	7	5	10		M 7 x 0,5	AISI 316 L	20KBKO05EVX
	4 x 6 mm	9		34	7	5	10		M 8 x 0,5	AISI 303	20KBKO06RVX
	4 x 6 mm	9		34	7	5	10		M 8 x 0,5	AISI 316 L	20KBKO06EVX
 <p>Panel Mount with Plastic Hose Connection</p>	3 x 4 mm	12	11	45	7	17	10	3	M 7 x 0,5	AISI 303	20KBKS04RVX
	3 x 5 mm	12	11	45	7	17	10	3	M 7 x 0,5	AISI 303	20KBKS05RVX
	4 x 6 mm	12	12	45	7	17	10	3,5	M 8 x 0,5	AISI 303	20KBKS06RVX



Plugs – with valve

Series 20KB

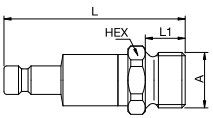
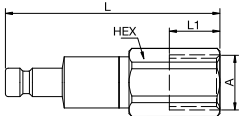
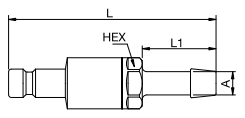
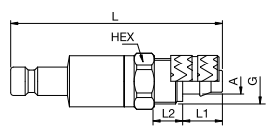
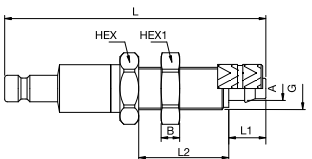
	Connection A	HEX mm	HEX1 mm	L mm	L1 mm	L2 mm	D mm	B mm	G mm	Version	Part Number
 <p>Male Thread</p>	M 5	9		28	5					AISI 303	20SBAM05RVX
	M 5	9		28	5					AISI 316 L	20SBAM05EVX
	G 1/8	11		30	7					AISI 303	20SBAW10RVX
	G 1/8	11		30	7					AISI 316 L	20SBAW10EVX
 <p>Female Thread</p>	G 1/8	12		30	7					AISI 303	20SBIW10RVX
	G 1/8	12		30	7					AISI 316 L	20SBIW10EVX
 <p>Hose Barb</p>	4 mm	8		37	13					AISI 316 L	20SBTF04EVX
 <p>with Plastic Hose Connection</p>	3 x 4 mm	9		36	7	5		M 7 x 0,5	AISI 316 L	20SBKO04EVX	
	3 x 5 mm	9		36	7	5		M 7 x 0,5	AISI 316 L	20SBKO05EVX	
	4 x 6 mm	9		36	7	5		M 8 x 0,5	AISI 303	20SBKO06RVX	
	4 x 6 mm	9		36	7	5		M 8 x 0,5	AISI 316 L	20SBKO06EVX	
 <p>Panel Mount with Plastic Hose Connection</p>	3 x 4 mm	12	11	47	7	17		3	M 7 x 0,5	AISI 303	20SBKS04RVX
	3 x 5 mm	12	11	47	7	17		3	M 7 x 0,5	AISI 303	20SBKS05RVX
	4 x 6 mm	12	12	47	7	17		3,5	M 8 x 0,5	AISI 303	20SBKS06RVX

Nominal Diameter

3 = 7 mm²

Rectus Series

303

Mini industrial coupling with plug profile according to ISO 6150 C. Popular profile in analytical and medical technology. Above average flow rate performance for liquid and gaseous media.

Series 303 with additional end connections available on request.

Working Temperature*

-15°C up to +200°C (FKM)
depending on the medium.

* For temperatures below -15°C and over +200°C and depending on the medium, other seal variants (EPDM, FFKM) are available.

**Working Pressure****

35 bar

** maximum static working pressure with design factor 4 to 1.

Material

Coupling: AISI 316L

Plug: AISI 316L

Seals: FKM

Technical Description

Dead space volume: 0,35 ml

Connecting Force 0 bar: 30 N

Connecting Force 6 bar: 60 N

Vacuum Coupling: 96%

Vacuum Plug: 96%

Vacuum connected: 96%

Interchangeability (KA only)

- ISO 6150 C

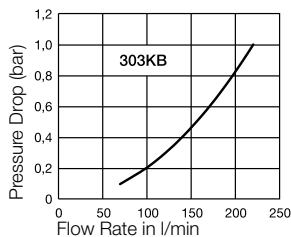
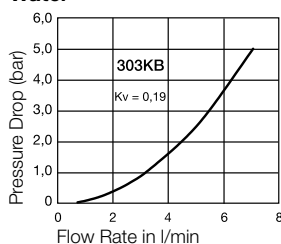
Flow diagrams**Air****Water**



Couplings – with valve

Series 303KB

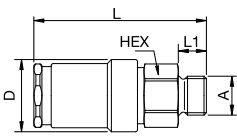
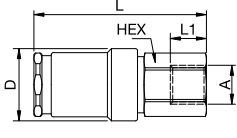
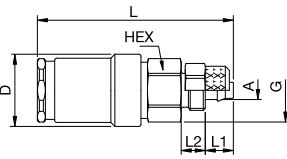
	Connection A	HEX mm	HEX1 mm	L mm	L1 mm	L2 mm	D mm	B mm	G mm	Version	Part Number
 <p>Male Thread</p>	G 1/8	14		43	7		18			AISI 316L	303KBAW10EVX
	G 1/4	17		45	9		18			AISI 316L	303KBAW13EVX
 <p>Female Thread</p>	G 1/8	14		43	9		18			AISI 316L	303KBIW10EVX
	G 1/4	17		45	9		18			AISI 316L	303KBIW13EVX
 <p>with Plastic Hose Connection</p>	4 x 6 mm	14	12	49	7	6	18		M 10 x 1	AISI 316L	303KBKO06EVX
	6 x 8 mm	14	14	49	7	6	18		M 12 x 1	AISI 316L	303KBKO08EVX



Plugs – with valve

Series 303KB

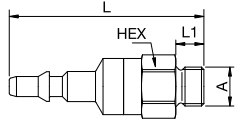
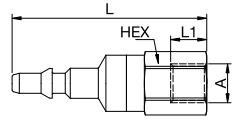
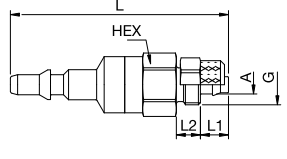
	Connection A	HEX mm	HEX1 mm	L mm	L1 mm	L2 mm	D mm	B mm	G mm	Version	Part Number
 <p>Male Thread</p>	G 1/8	14		48,5	7					AISI 316L	303SBAW10EVX
	G 1/4	17		50,5	9					AISI 316L	303SBAW13EVX
 <p>Female Thread</p>	G 1/8	14		48,5	9					AISI 316L	303SBIW10EVX
	G 1/4	17		50,5	9					AISI 316L	303SBIW13EVX
 <p>with Plastic Hose Connection</p>	4 x 6 mm	14	12	54,5	7	6			M 10 x 1	AISI 316L	303SBKO06EVX
	6 x 8 mm	14	14	54,5	7	6			M 12 x 1	AISI 316L	303SBKO08EVX

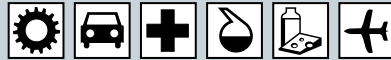

Mini industrial coupling with the world's most popular profile in this nominal diameter. Above average flow performance for liquid and gaseous media. Coupling system with single-hand operation. Small dimensions and large band width in materials and valve variants.

Series 21 with additional end connections available on request.

Dust Protections  (P. 250)
for Coupling Part.-No. SK16S

Working Temperature*
-15°C up to +200°C (FKM)
depending on the medium.

* For temperatures below -15°C and over +200°C and depending on the medium, other seal variants (EPDM, FFKM) are available.



Other designs in series 21

The following other designs can be found from page:

- Brass / Steel P. 26
- Thermoplastic P. 176
- Safety P. 210
- Coded Systems P. 234

Interchangeability (KA only)

- Camozzi
- EWO
- Kani

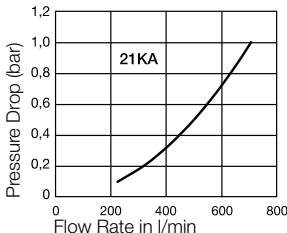
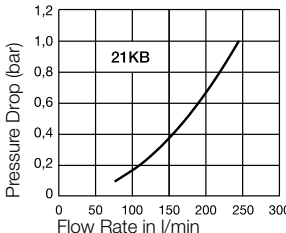
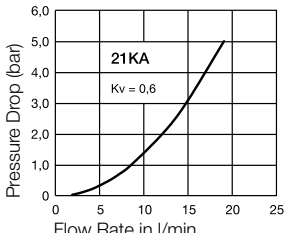
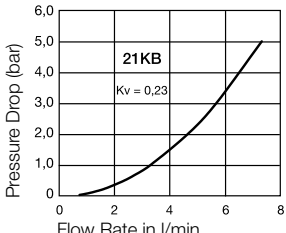
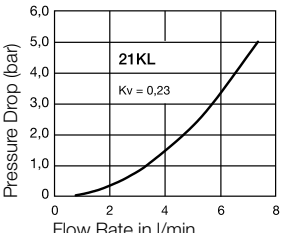
 KA Single Shut-Off	 KB Double Shut-Off	 KL Dry-break
Working Pressure**		
35 bar ** maximum static working pressure with design factor 4 to 1.	35 bar	8 bar
Features		
• All variants interchangeable		• Minimal, almost imperceptible leakage when uncoupling • No air locked into the system during the coupling process
Material		
Coupling: AISI 303 / AISI 316 L Plug: AISI 303 / AISI 316 L Seals: FKM	Coupling: AISI 303 / AISI 316 L Plug: AISI 303 / AISI 316 L Seals: FKM	Coupling: AISI 303 / AISI 316 L Plug: AISI 303 / AISI 316 L Seals: FKM
Technical Description		
Connecting Force 0 bar: 35 N Connecting Force 6 bar: 60 N Vacuum Coupling: 96% Vacuum connected: 96%	Dead space volume: 0,6 ml Connecting Force 0 bar: 40 N Connecting Force 6 bar: 80 N Vacuum Coupling: 96% Vacuum Plug: 96% Vacuum connected: 96%	Dead space volume: 0,0006 ml Connecting Force 0 bar: 35 N Connecting Force 6 bar: 60 N Vacuum Coupling: 96% Vacuum Plug: 96% Vacuum connected: 96%
Flow diagrams		
Air	Air	
		
Water	Water	Water
		



Couplings – with valve

Series 21KA

	Connection A	HEX mm	HEX1 mm	L mm	L1 mm	L2 mm	D mm	B mm	G mm	Version	Part Number
<p>Male Thread</p>	G 1/8	14		36	7		16			AISI 303	21KAAW10RVX
	G 1/8	14		36	7		16			AISI 316 L	21KAAW10EVX
	G 1/4	17		38	9		16			AISI 303	21KAAW13RVX
	G 1/4	17		38	9		16			AISI 316 L	21KAAW13EVX
	G 3/8	19		38	9		16			AISI 303	21KAAW17RVX
	G 3/8	19		38	9		16			AISI 316 L	21KAAW17EVX
<p>Female Thread</p>	G 1/8	14		36	9		16			AISI 303	21KAIW10RVX
	G 1/8	14		36	9		16			AISI 316 L	21KAIW10EVX
	G 1/4	17		38	9		16			AISI 303	21KAIW13RVX
	G 1/4	17		38	9		16			AISI 316 L	21KAIW13EVX
<p>Hose Barb</p>	6 mm	14		46	17		16			AISI 303	21KATF06RVX
	6 mm	14		46	17		16			AISI 316 L	21KATF06EVX
	8 mm	14		46	17		16			AISI 303	21KATF08RVX
	9 mm	14		46	17		16			AISI 303	21KATF09RVX
	10 mm	14		46	17		16			AISI 316 L	21KATF10EVX
<p>with Plastic Hose Connection</p>	4 x 6 mm	14		42	7	6	16		M 10 x 1	AISI 303	21KAKO06RVX
	4 x 6 mm	14		42	7	6	16		M 10 x 1	AISI 316 L	21KAKO06EVX
	6 x 8 mm	14		42	7	6	16		M 12 x 1	AISI 303	21KAKO08RVX



Plugs – without valve

Series 21KA

	Connection A	HEX mm	HEX1 mm	L mm	L1 mm	L2 mm	D mm	B mm	G mm	Version	Part Number
<p>Male Thread</p>	G 1/8	14		25	7					AISI 303	21SFAW10RXX
	G 1/8	14		25	7					AISI 316 L	21SFAW10EXX
	G 1/4	17		28	9					AISI 303	21SFAW13RXX
	G 1/4	17		28	9					AISI 316 L	21SFAW13EXX
	G 3/8	19		28	9					AISI 303	21SFAW17RXX
<p>Female Thread</p>	G 1/8	14		25	8					AISI 303	21SFIW10RXX
	G 1/8	14		25	8					AISI 316 L	21SFIW10EXX
	G 1/4	17		25	9					AISI 303	21SFIW13RXX
	G 1/4	17		25	9					AISI 316 L	21SFIW13EXX
	G 3/8	19		26	9					AISI 303	21SFIW17RXX

 **Plugs – without valve**
Series 21KA

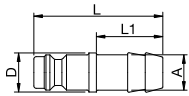
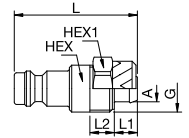
	Connection A	HEX mm	HEX1 mm	L mm	L1 mm	L2 mm	D mm	B mm	G mm	Version	Part Number
 <p>Hose Barb</p>	6 mm			32	17		9			AISI 303	21SFTF06RXX
	6 mm			32	17		9			AISI 316 L	21SFTF06EXX
	8 mm			32	17		9			AISI 303	21SFTF08RXX
	8 mm			32	17		9			AISI 316 L	21SFTF08EXX
	10 mm			33	17		12			AISI 303	21SFTF10RXX
	10 mm			33	17		12			AISI 316 L	21SFTF10EXX
 <p>with Plastic Hose Connection</p>	4 x 6 mm	12	12	32	7	6			M 10 x 1	AISI 303	21SFKO06RXX
	4 x 6 mm	12	12	32	7	6			M 10 x 1	AISI 316 L	21SFKO06EXX
	6 x 8 mm	14	14	32	7	6			M 12 x 1	AISI 303	21SFKO08RXX
	6 x 8 mm	14	14	32	7	6			M 12 x 1	AISI 316 L	21SFKO08EXX

 **Couplings – with valve**
Series 21KB

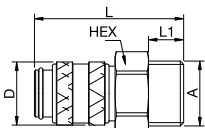
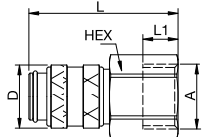
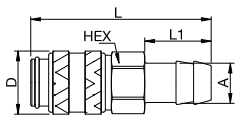
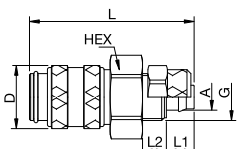
	Connection A	HEX mm	HEX1 mm	L mm	L1 mm	L2 mm	D mm	B mm	G mm	Version	Part Number
 <p>Male Thread</p>	G 1/8	14		36	7		16			AISI 303	21KBAW10RVX
	G 1/8	14		36	7		16			AISI 316 L	21KBAW10EVX
	G 1/4	17		38	9		16			AISI 303	21KBAW13RVX
	G 1/4	17		38	9		16			AISI 316 L	21KBAW13EVX
	G 3/8	19		38	9		16			AISI 303	21KBAW17RVX
	G 3/8	19		38	9		16			AISI 316 L	21KBAW17EVX
 <p>Female Thread</p>	G 1/8	14		36	9		16			AISI 303	21KBIW10RVX
	G 1/8	14		36	9		16			AISI 316 L	21KBIW10EVX
	G 1/4	17		38	7		16			AISI 303	21KBIW13RVX
	G 1/4	17		38	7		16			AISI 316 L	21KBIW13EVX
 <p>Hose Barb</p>	6 mm	14		46	17		16			AISI 303	21KBTF06RVX
	6 mm	14		46	17		16			AISI 316 L	21KBTF06EVX
	8 mm	14		46	17		16			AISI 303	21KBTF08RVX
	9 mm	14		46	17		16			AISI 303	21KBTF09RVX
	10 mm	14		46	17		16			AISI 316 L	21KBTF10EVX
	 <p>with Plastic Hose Connection</p>	4 x 6 mm	14		42	7	6	16		M 10 x 1	AISI 303
4 x 6 mm		14		42	7	6	16		M 10 x 1	AISI 316 L	21KBKO06EVX
6 x 8 mm		14		42	7	6	16		M 12 x 1	AISI 303	21KBKO08RVX

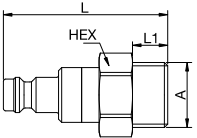
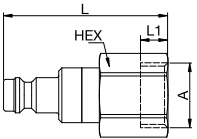
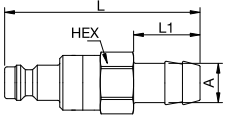
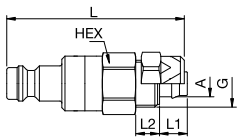

	Connection A	HEX mm	HEX1 mm	L mm	L1 mm	L2 mm	D mm	B mm	G mm	Version	Part Number
 <p>Male Thread</p>	G 1/8	14		40	7					AISI 303	21SBAW10RVX
	G 1/8	14		40	7					AISI 316 L	21SBAW10EVX
	G 1/4	17		42	9					AISI 303	21SBAW13RVX
	G 1/4	17		42	9					AISI 316 L	21SBAW13EVX
	G 3/8	19		42	9					AISI 303	21SBAW17RVX
	G 3/8	19		42	9					AISI 316 L	21SBAW17EVX
 <p>Female Thread</p>	G 1/8	14		40	9					AISI 303	21SBIW10RVX
	G 1/8	14		40	9					AISI 316 L	21SBIW10EVX
	G 1/4	17		42	7					AISI 303	21SBIW13RVX
	G 1/4	17		42	7					AISI 316 L	21SBIW13EVX
 <p>Hose Barb</p>	6 mm	14		50	17					AISI 303	21SBTF06RVX
	6 mm	14		50	17					AISI 316 L	21SBTF06EVX
	8 mm	14		50	17					AISI 303	21SBTF08RVX
	9 mm	14		50	17					AISI 303	21SBTF09RVX
	10 mm	14		50	17					AISI 316 L	21SBTF10EVX
 <p>with Plastic Hose Connection</p>	4 x 6 mm	14		46	7	6			M 10 x 1	AISI 303	21SBKO06RVX
	4 x 6 mm	14		46	7	6			M 10 x 1	AISI 316 L	21SBKO06EVX
	6 x 8 mm	14		46	7	6			M 12 x 1	AISI 303	21SBKO08RVX

Couplings – flat sealing **Series 21KL**

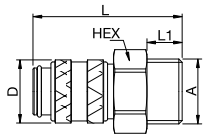
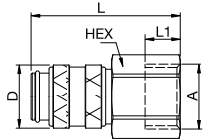
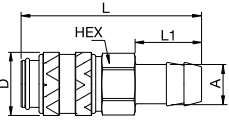
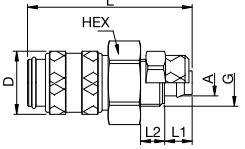
	Connection A	HEX mm	HEX1 mm	L mm	L1 mm	L2 mm	D mm	B mm	G mm	Version	Part Number
 <p>Male Thread</p>	G 1/8	14		36	7		16			AISI 303	21KLAW10RVX
	G 1/8	14		36	7		16			AISI 316 L	21KLAW10EVX
	G 1/4	17		38	9		16			AISI 303	21KLAW13RVX
	G 1/4	17		38	9		16			AISI 316 L	21KLAW13EVX
	G 3/8	19		38	9		16			AISI 303	21KLAW17RVX
	G 3/8	19		38	9		16			AISI 316 L	21KLAW17EVX
 <p>Female Thread</p>	G 1/8	14		36	9		16			AISI 303	21KLIW10RVX
	G 1/8	14		36	9		16			AISI 316 L	21KLIW10EVX
	G 1/4	17		38	9		16			AISI 303	21KLIW13RVX
	G 1/4	17		38	9		16			AISI 316 L	21KLIW13EVX
 <p>Hose Barb</p>	6 mm	14		46	17		16			AISI 316 L	21KLTF06EVX
	8 mm	14		46	17		16			AISI 303	21KLTF08RVX
	8 mm	14		46	17		16			AISI 316 L	21KLTF08EVX
	10 mm	14		46	17		16			AISI 316 L	21KLTF10EVX
 <p>with Plastic Hose Connection</p>	4 x 6 mm	14		42	7	6	16		M 10 x 1	AISI 303	21KLKO06RVX
	4 x 6 mm	14		42	7	6	16		M 10 x 1	AISI 316 L	21KLKO06EVX
	6 x 8 mm	14		42	7	6	16		M 12 x 1	AISI 303	21KLKO08RVX
	6 x 8 mm	14		42	7	6	16		M 12 x 1	AISI 316 L	21KLKO08EVX

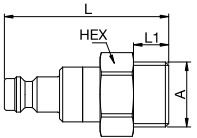
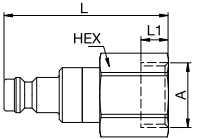
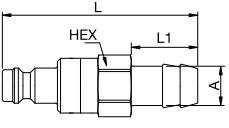
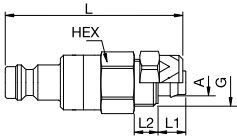

	Connection A	HEX mm	HEX1 mm	L mm	L1 mm	L2 mm	D mm	B mm	G mm	Version	Part Number
 <p>Male Thread</p>	G 1/8	14		40	7					AISI 303	21SLAW10RVX
	G 1/8	14		40	7					AISI 316 L	21SLAW10EVX
	G 1/4	17		42	9					AISI 303	21SLAW13RVX
	G 1/4	17		42	9					AISI 316 L	21SLAW13EVX
	G 3/8	19		42	9					AISI 303	21SLAW17RVX
	G 3/8	19		42	9					AISI 316 L	21SLAW17EVX
 <p>Female Thread</p>	G 1/8	14		40	9					AISI 303	21SLIW10RVX
	G 1/8	14		40	9					AISI 316 L	21SLIW10EVX
 <p>Hose Barb</p>	5 mm	14		50	17					AISI 316 L	21SLTF05EVX
	6 mm	14		50	17					AISI 303	21SLTF06RVX
	6 mm	14		50	17					AISI 316 L	21SLTF06EVX
	10 mm	14		50	17					AISI 303	21SLTF10RVX
	10 mm	14		50	17					AISI 316 L	21SLTF10EVX
 <p>with Plastic Hose Connection</p>	4 x 6 mm	14		46	7	6			M 10 x 1	AISI 303	21SLKO06RVX
	4 x 6 mm	14		46	7	6			M 10 x 1	AISI 316 L	21SLKO06EVX
	6 x 8 mm	14		46	7	6			M 12 x 1	AISI 303	21SLKO08RVX
	6 x 8 mm	14		46	7	6			M 12 x 1	AISI 316 L	21SLKO08EVX

Nominal Diameter

7,4 = 43 mm²

Tema Series

1300**Other designs in series 1300**

The following other designs can be found from page:

► Brass / Steel

P. 64

Interchangeability (KA only)

- Tema Design

Series 1300 is used mainly for applications in the area of compressed air and liquids. Optimally suited to use with liquid and aggressive media. The coupling series stands out for its compact design and corrosion resistance. Ultra High Flow valve for optimum flow and low pressure drop.

Series 1300 with additional end connections available on request.

Dust Protections  (P. 250)
for Coupling Part.-No. 1315-QC
for Plug Part.-No. 1325-QC

Working Temperature*
-25°C up to +200°C (FKM)
depending on the medium.

* For temperatures below -25°C and over +200°C and depending on the medium, other seal variants (EPDM, FFKM) are available.

**Working Pressure****

35 bar

** maximum static working pressure with design factor 4 to 1.

50 bar

Features

- Single-hand operation

- Two-hand operation

Material

Coupling: AISI 316

Plug: AISI 316

Seals: FKM

Coupling: AISI 316

Plug: AISI 316

Seals: FKM

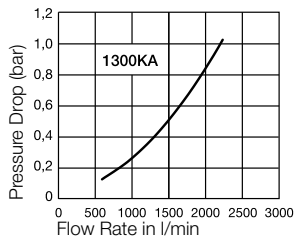
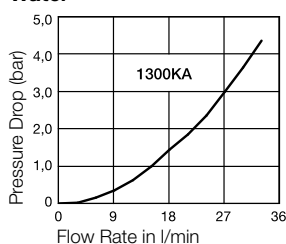
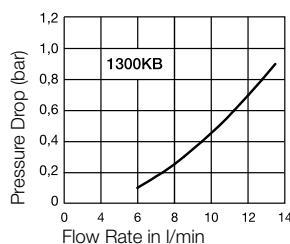
Flow diagrams**Air****Water****Water**



Couplings – with valve

Series 1300KA

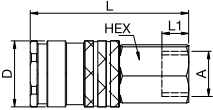
	Connection A	HEX mm	L mm	L1 mm	D mm	Part Number
 <p>Female Thread</p>	G 1/4	18	49	8,75	22	1300KAIW13EVX



Plugs – without valve

Series 1300KA

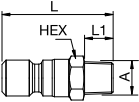
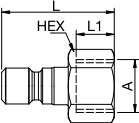
	Connection A	HEX mm	L mm	L1 mm	D mm	Part Number
 <p>Male Thread</p>	G 1/8	13	35	9		1300SFAW10EXX
 <p>Female Thread</p>	G 1/4	16	36	10		1300SFIW13EXX



Couplings – with valve

Series 1300KB

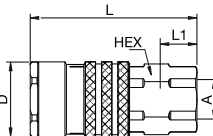
	Connection A	HEX mm	L mm	L1 mm	D mm	Part Number
 <p>Female Thread</p>	G 1/4	18	49	8	22	1300KBIW13EVX





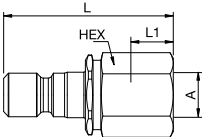

Plugs – with valve

Series 1300KB

	Connection A	HEX mm	L mm	L1 mm	D mm	Part Number
 <p>Female Thread</p>	G 1/4	18	44	9		1300SBIW13EVX

Cross-Reference-List

Connection	Thread	Rectus Part Number old	Tema Part Number old	Part Number new	Page
 Couplings – with valve					
Female Thread	G 1/4		1300 RV	1300KAIW13EVX	147
 Plugs – without valve					
Male Thread	G 1/8		13110 R	1300SFAW10EXX	147
Female Thread	G 1/4		13410 R	1300SFIW13EXX	147
 Couplings – with valve					
Female Thread	G 1/4		1300 NRV	1300KBIW13EVX	147
 Plugs – with valve					
Female Thread	G 1/4		13410 RV	1300SBIW13EVX	147



Other designs in series 25

The following other designs can be found from page:

- Brass / Steel P. 70
- Safety P. 214
- Safety Self-Venting P. 230
- Coded Systems P. 236

Interchangeability (KA only)

- Rectus 26
- Cejn 320
- various German Products

Universal industrial coupling with standard European profile for use with gaseous, liquid and aggressive media.

Coupling system with single-hand operation. High Flow valve for optimum flow and low pressure drop. The series stands out for its robust design and long service life even with the harshest use. The collar design minimises damage to the valve body.

Series 25 with additional end connections available on request.

Dust Protections (P. 250)
for Coupling Part.-No. SK23S
for Plug Part.-No. SK12S

Working Temperature*
-15°C up to +200°C (FKM)
depending on the medium.

* For temperatures below -15°C and over +200°C and depending on the medium, other seal variants (EPDM, FFKM) are available.



Working Pressure**

35 bar
** maximum static working pressure with design factor 4 to 1.

35 bar

8 bar

Features

- Minimal, almost imperceptible leakage when uncoupling
- No air locked into the system during the coupling process

Material

Coupling: AISI 303 / AISI 316 L
Plug: AISI 303 / AISI 316 L
Seals: FKM

Coupling: AISI 303 / AISI 316 L
Plug: AISI 303 / AISI 316 L
Seals: FKM

Coupling: AISI 303 / AISI 316 L
Plug: AISI 303 / AISI 316 L
Seals: FKM

Technical Description

Connecting Force 0 bar: 40 N
Connecting Force 6 bar: 120 N

Dead space volume: 1,5 ml

Dead space volume: 0,001 ml

Vacuum Coupling: 96%
Available on request with O-ring seal for vacuum when coupled.

Connecting Force 0 bar: 40 N
Connecting Force 6 bar: 120 N

Connecting Force 0 bar: 40 N
Connecting Force 6 bar: 120 N

Vacuum Coupling: 96%
Vacuum Plug: 96%
Available on request with O-ring seal for vacuum when coupled.

Vacuum Coupling: 96%
Vacuum Plug: 96%
Vacuum connected: 96%

Flow diagrams

Air

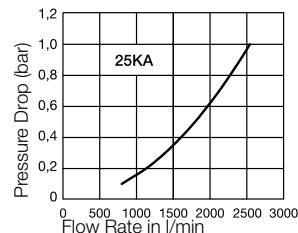

Air

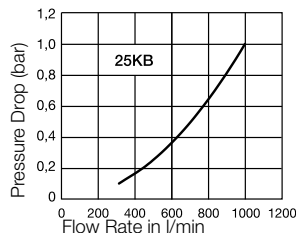

Water

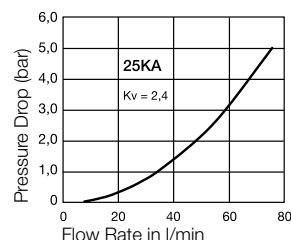

Water

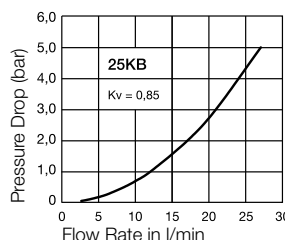

Water

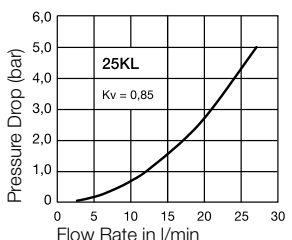



Couplings – with valve

Series 25KA

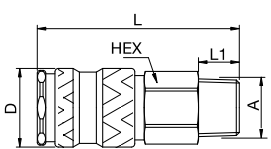
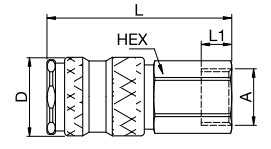
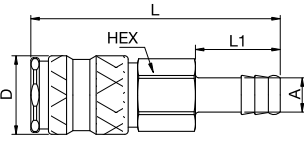
	Connection A	HEX mm	L mm	L1 mm	D mm	Version	Part Number
 <p>Male Thread</p>	G 1/4	19	59,5	10,5	23	AISI 303	25KAAW13RVX
	G 1/4	19	59,5	10,5	23	AISI 316 L	25KAAW13EVX
	G 3/8	19	57,5	9	23	AISI 303	25KAAW17RVX
	G 3/8	19	57,5	9	23	AISI 316 L	25KAAW17EVX
	G 1/2	24	60,5	12	23	AISI 303	25KAAW21RVX
	G 1/2	24	60,5	12	23	AISI 316 L	25KAAW21EVX
 <p>Female Thread</p>	G 1/4	19	55,5	10	23	AISI 303	25KAIW13RVX
	G 1/4	19	55,5	10	23	AISI 316 L	25KAIW13EVX
	G 3/8	19	54,5	9	23	AISI 303	25KAIW17RVX
	G 3/8	19	54,5	9	23	AISI 316 L	25KAIW17EVX
	G 1/2	24	57,5	12	23	AISI 303	25KAIW21RVX
	G 1/2	24	57,5	12	23	AISI 316 L	25KAIW21EVX
 <p>Hose Barb</p>	6 mm	19	73,5	25	23	AISI 316 L	25KATF06EVX
	8 mm	19	73,5	25	23	AISI 316 L	25KATF08EVX
	9 mm	19	73,5	25	23	AISI 316 L	25KATF09EVX
	10 mm	19	73,5	25	23	AISI 303	25KATF10RVX
	13 mm	19	73,5	25	23	AISI 303	25KATF13RVX



Plugs – without valve

Series 25KA

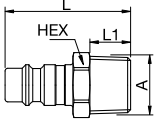
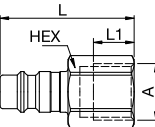
	Connection A	HEX mm	L mm	L1 mm	D mm	Version	Part Number
 <p>Male Thread</p>	G 1/8	14	31	7		AISI 303	25SFAW10RXX
	G 1/4	17	33	9		AISI 303	25SFAW13RXX
	G 1/4	17	33	9		AISI 316 L	25SFAW13EXX
	G 3/8	19	33	9		AISI 303	25SFAW17RXX
	G 3/8	19	33	9		AISI 316 L	25SFAW17EXX
	G 1/2	24	38	12		AISI 303	25SFAW21RXX
 <p>Female Thread</p>	G 1/2	24	38	12		AISI 316 L	25SFAW21EXX
	G 1/8	14	30	7		AISI 303	25SFIW10RXX
	G 1/4	17	33	10		AISI 303	25SFIW13RXX
	G 1/4	17	33	10		AISI 316 L	25SFIW13EXX
	G 3/8	19	33	10		AISI 303	25SFIW17RXX
	G 3/8	19	33	10		AISI 316 L	25SFIW17EXX
	G 1/2	24	35	12		AISI 303	25SFIW21RXX
	G 1/2	24	35	12		AISI 316 L	25SFIW21EXX



Plugs – without valve

Series 25KA

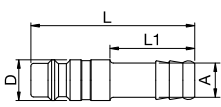
	Connection A	HEX mm	L mm	L1 mm	D mm	Version	Part Number
 <p>Hose Barb</p>	6 mm		48	25	12	AISI 303	25SFTF06RXX
	6 mm		48	25	12	AISI 316 L	25SFTF06EXX
	8 mm		48	25	12	AISI 303	25SFTF08RXX
	8 mm		48	25	12	AISI 316 L	25SFTF08EXX
	9 mm		48	25	12	AISI 303	25SFTF09RXX
	9 mm		48	25	12	AISI 316 L	25SFTF09EXX
	10 mm		48	25	12	AISI 303	25SFTF10RXX
	10 mm		48	25	12	AISI 316 L	25SFTF10EXX
	13 mm		48	25	15	AISI 303	25SFTF13RXX
	13 mm		48	25	15	AISI 316 L	25SFTF13EXX



Couplings – with valve

Series 25KB

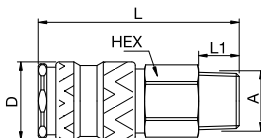
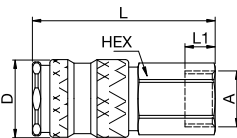
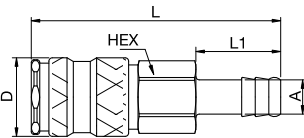
	Connection A	HEX mm	L mm	L1 mm	D mm	Version	Part Number
 <p>Male Thread</p>	G 1/4	19	59,5	10,5	23	AISI 303	25KBAW13RVX
	G 1/4	19	59,5	10,5	23	AISI 316 L	25KBAW13EVX
	G 3/8	19	57,5	9	23	AISI 303	25KBAW17RVX
	G 3/8	19	57,5	9	23	AISI 316 L	25KBAW17EVX
	G 1/2	24	60,5	12	23	AISI 303	25KBAW21RVX
	G 1/2	24	60,5	12	23	AISI 316 L	25KBAW21EVX
 <p>Female Thread</p>	G 1/4	19	55,5	10	23	AISI 303	25KBIW13RVX
	G 1/4	19	55,5	10	23	AISI 316 L	25KBIW13EVX
	G 3/8	19	54,5	9	23	AISI 303	25KBIW17RVX
	G 3/8	19	54,5	9	23	AISI 316 L	25KBIW17EVX
	G 1/2	24	57,5	12	23	AISI 316 L	25KBIW21EVX
 <p>Hose Barb</p>	6 mm	19	73,5	25	23	AISI 316 L	25KBTf06EVX
	8 mm	19	73,5	25	23	AISI 316 L	25KBTf08EVX
	9 mm	19	73,5	25	23	AISI 316 L	25KBTf09EVX

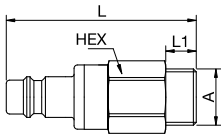
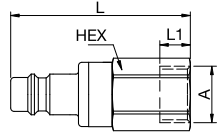
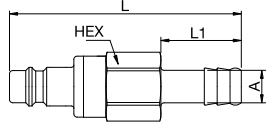

	Connection A	HEX mm	L mm	L1 mm	D mm	Version	Part Number
 <p>Male Thread</p>	G 1/4	19	58	10,5		AISI 303	25SBAW13RVX
	G 1/4	19	58	10,5		AISI 316 L	25SBAW13EVX
	G 3/8	19	56	9		AISI 303	25SBAW17RVX
	G 3/8	19	56	9		AISI 316 L	25SBAW17EVX
	G 1/2	24	59	12		AISI 303	25SBAW21RVX
	G 1/2	24	59	12		AISI 316 L	25SBAW21EVX
 <p>Female Thread</p>	G 1/4	19	54	10		AISI 303	25SBIW13RVX
	G 1/4	19	54	10		AISI 316 L	25SBIW13EVX
	G 3/8	19	53	9		AISI 303	25SBIW17RVX
	G 3/8	19	53	9		AISI 316 L	25SBIW17EVX
	G 1/2	24	56	12		AISI 316 L	25SBIW21EVX
	 <p>Hose Barb</p>	6 mm	19	72	25		AISI 316 L
8 mm		19	72	25		AISI 316 L	25SBTF08EVX
9 mm		19	72	25		AISI 316 L	25SBTF09EVX

Couplings – flat sealing Series 25KL

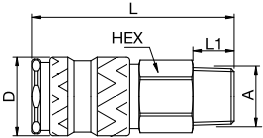
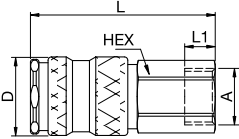
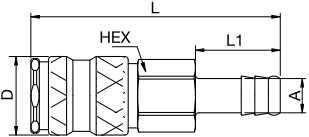
	Connection A	HEX mm	L mm	L1 mm	D mm	Version	Part Number
 <p>Male Thread</p>	G 1/4	19	59,5	10,5	23	AISI 303	25KLAW13RVX
	G 1/4	19	59,5	10,5	23	AISI 316 L	25KLAW13EVX
	G 3/8	19	57,5	9	23	AISI 303	25KLAW17RVX
	G 3/8	19	57,5	9	23	AISI 316 L	25KLAW17EVX
	G 1/2	24	60,5	12	23	AISI 303	25KLAW21RVX
	G 1/2	24	60,5	12	23	AISI 316 L	25KLAW21EVX
 <p>Female Thread</p>	G 1/4	19	55,5	10	23	AISI 303	25KLIW13RVX
	G 1/4	19	55,5	10	23	AISI 316 L	25KLIW13EVX
	G 3/8	19	54,5	9	23	AISI 303	25KLIW17RVX
	G 3/8	19	54,5	9	23	AISI 316 L	25KLIW17EVX
	G 1/2	24	57,5	12	23	AISI 303	25KLIW21RVX
	G 1/2	24	57,5	12	23	AISI 316 L	25KLIW21EVX
 <p>Hose Barb</p>	9 mm	19	73,5	25	23	AISI 303	25KLTf09RVX
	9 mm	19	73,5	25	23	AISI 316 L	25KLTf09EVX

Plugs – flat sealing Series 25KL

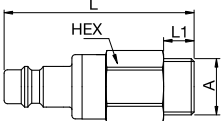
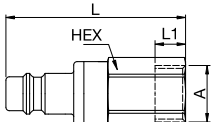
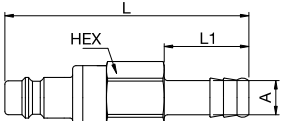
	Connection A	HEX mm	L mm	L1 mm	D mm	Version	Part Number
 <p>Male Thread</p>	G 1/4	19	58	10,5		AISI 303	25SLAW13RVX
	G 1/4	19	58	10,5		AISI 316 L	25SLAW13EVX
	G 3/8	19	56	9		AISI 303	25SLAW17RVX
	G 3/8	19	56	9		AISI 316 L	25SLAW17EVX
	G 1/2	24	59	12		AISI 303	25SLAW21RVX
	G 1/2	24	59	12		AISI 316 L	25SLAW21EVX
 <p>Female Thread</p>	G 1/4	19	54	10		AISI 303	25SLIW13RVX
	G 1/4	19	54	10		AISI 316 L	25SLIW13EVX
	G 3/8	19	53	9		AISI 303	25SLIW17RVX
	G 3/8	19	53	9		AISI 316 L	25SLIW17EVX
	G 1/2	24	56	12		AISI 303	25SLIW21RVX
	G 1/2	24	56	12		AISI 316 L	25SLIW21EVX
 <p>Hose Barb</p>	6 mm	19	75	25		AISI 303	25SLTF06RVX
	9 mm	19	72	25		AISI 303	25SLTF09RVX
	9 mm	19	72	25		AISI 316 L	25SLTF09EVX

Nominal Diameter

10 = 80 mm²

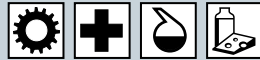

Rectus Series

27

Low Pressure



1/2" universal industrial coupling with standard European profile for use with large pneumatic consumers. Coupling system with single-hand operation. High Flow valve for optimum flow and low pressure drop. The series stands out for its robust design, extremely high flow and long service life even with the harshest use. The collar design minimises damage to the valve body.

Dust Protections  (P. 250)
for Coupling Part.-No. SK27S

Working Temperature*
-15°C up to +200°C (FKM)
depending on the medium.

* For temperatures below -15°C and over +200°C and depending on the medium, other seal variants (EPDM, FFKM) are available.

Series 27 with additional end connections available on request.

Other designs in series 27

The following other designs can be found from page:

- ▶ Brass / Steel P. 86
- ▶ Safety Self-Venting P. 232

Interchangeability (KA only)

- Cejn 410



Working Pressure**

35 bar
** maximum static working pressure with design factor 4 to 1.

35 bar

Material

Coupling: AISI 303 / AISI 316 L
Plug: AISI 303 / AISI 316 L
Seals: FKM

Coupling: AISI 303 / AISI 316 L
Plug: AISI 303 / AISI 316 L
Seals: FKM

Technical Description

Connecting Force 0 bar: 60 N
Connecting Force 6 bar: 180 N

Dead space volume: 2,2 ml

Vacuum Coupling: 87%
Available on request with O-ring seal for vacuum when coupled.

Connecting Force 0 bar: 60 N
Connecting Force 6 bar: 180 N

Vacuum Coupling: 96%
Vacuum Plug: 96%
Available on request with O-ring seal for vacuum when coupled.

Flow diagrams

Air

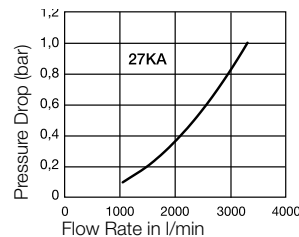

Air

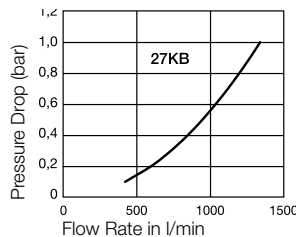

Water

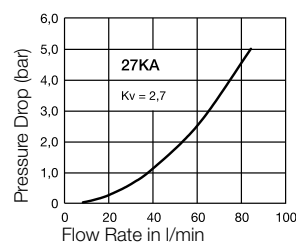

Water

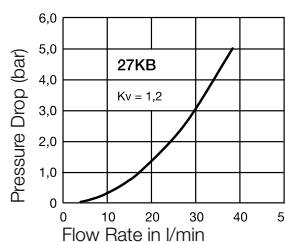



Couplings – with valve

Series 27KA

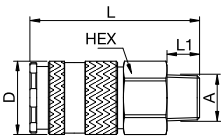
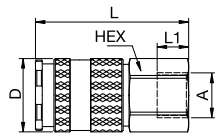
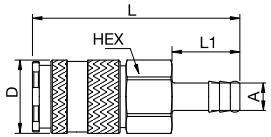
	Connection A	HEX mm	L mm	L1 mm	D mm	Version	Part Number
 <p>Male Thread</p>	G 3/8	24	57,5	9	27	AISI 303	27KAAW17RVX
	G 3/8	24	57,5	9	27	AISI 316 L	27KAAW17EVX
	G 1/2	24	59,5	12	27	AISI 303	27KAAW21RVX
	G 1/2	24	59,5	12	27	AISI 316 L	27KAAW21EVX
	G 3/4	32	60,5	16	27	AISI 303	27KAAW26RVX
	G 3/4	32	60,5	16	27	AISI 316 L	27KAAW26EVX
 <p>Female Thread</p>	G 1/2	24	56,5	12	27	AISI 303	27KAIW21RVX
	G 1/2	24	56,5	12	27	AISI 316 L	27KAIW21EVX
	G 3/4	32	60,5	16	27	AISI 316 L	27KAIW26EVX
 <p>Hose Barb</p>	13 mm	24	76,5	25	27	AISI 303	27KATF13RVX
	13 mm	24	76,5	25	27	AISI 316 L	27KATF13EVX



Plugs – without valve

Series 27KA

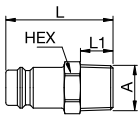
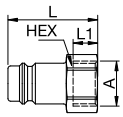
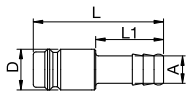
	Connection A	HEX mm	L mm	L1 mm	D mm	Version	Part Number
 <p>Male Thread</p>	G 1/4	17	36,5	9		AISI 303	27SFAW13RXX
	G 1/4	17	36,5	9		AISI 316 L	27SFAW13EXX
	G 3/8	19	36,5	9		AISI 303	27SFAW17RXX
	G 1/2	24	40	12		AISI 303	27SFAW21RXX
	G 1/2	24	40	12		AISI 316 L	27SFAW21EXX
 <p>Female Thread</p>	G 1/2	24	37	12		AISI 303	27SFIW21RXX
	G 1/2	24	37	12		AISI 316 L	27SFIW21EXX
	G 3/4	32	42	16		AISI 303	27SFIW26RXX
 <p>Hose Barb</p>	8 mm		48	25	15	AISI 303	27SFTF08RXX
	9 mm		48	25	15	AISI 303	27SFTF09RXX
	13 mm		48	25	15	AISI 303	27SFTF13RXX
	13 mm		48	25	15	AISI 316 L	27SFTF13EXX
	19 mm		49	25	21	AISI 303	27SFTF19RXX



Couplings – with valve

Series 27KB

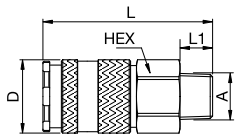
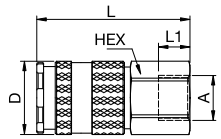
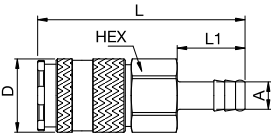
	Connection A	HEX mm	L mm	L1 mm	D mm	Version	Part Number
 <p>Male Thread</p>	G 3/8	24	57,5	9	27	AISI 303	27KBAW17RVX
	G 3/8	24	57,5	9	27	AISI 316 L	27KBAW17EVX
	G 1/2	24	59,5	12	27	AISI 303	27KBAW21RVX
	G 1/2	24	59,5	12	27	AISI 316 L	27KBAW21EVX
	G 3/4	32	60,5	16	27	AISI 316 L	27KBAW26EVX
 <p>Female Thread</p>	G 1/2	24	56,5	12	27	AISI 303	27KBIW21RVX
	G 1/2	24	56,5	12	27	AISI 316 L	27KBIW21EVX
 <p>Hose Barb</p>	13 mm	24	76,5	25	27	AISI 316 L	27KBTF13EVX



Plugs – with valve

Series 27KB

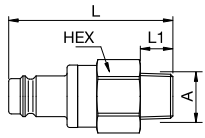
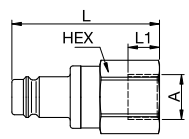
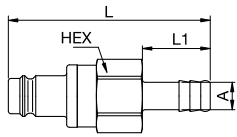
	Connection A	HEX mm	L mm	L1 mm	D mm	Version	Part Number
 <p>Male Thread</p>	G 1/2	24	57,5	12		AISI 303	27SBAW21RVX
	G 1/2	24	57,5	12		AISI 316 L	27SBAW21EVX
 <p>Female Thread</p>	G 1/4	24	54,5	10		AISI 316 L	27SBIW13EVX
	G 1/2	24	54,5	12		AISI 303	27SBIW21RVX
	G 1/2	24	54,5	12		AISI 316 L	27SBIW21EVX
 <p>Hose Barb</p>	13 mm	24	74,5	25		AISI 303	27SBTF13RVX
	13 mm	24	74,5	25		AISI 316 L	27SBTF13EVX

Nominal Diameter

9,5 = 71 mm²

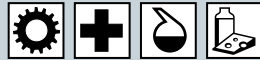

Tema Series

1800



Other designs in series 1800

The following other designs can be found from page:

- Brass / Steel P. 94

The 1800 series in stainless steel is used mainly for applications in the area of liquids with aggressive media. The coupling system stands out for its robust, compact design and high corrosion resistance. Ultra High Flow valve for optimum flow and low pressure drop.

Series 1800 with additional end connections available on request.

Dust Protections  (P. 250)
for Coupling Part.-No. 5026-QC
for Plug Part.-No. 2526-QC

Working Temperature*
-25°C up to +200°C (FKM)
depending on the medium.

* For temperatures below -25°C and over +200°C and depending on the medium, other seal variants (EPDM, FFKM) are available.



Working Pressure**

35 bar
** maximum static working pressure with design factor 4 to 1.

50 bar

Features

- Single-hand operation
- Two-hand operation

Material

Coupling: AISI 303 / AISI 316
Plug: AISI 303 / AISI 316
Seals: FKM

Coupling: AISI 316
Plug: AISI 316
Seals: FKM

Interchangeability (KA only)

- Tema Design

Flow diagrams

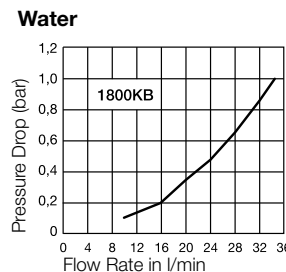
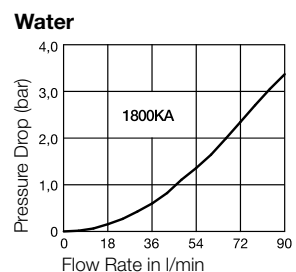
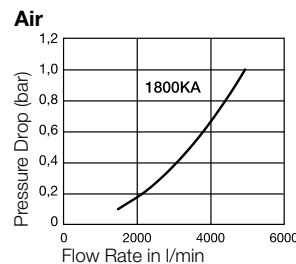



Couplings – with valve

Series 1800KA

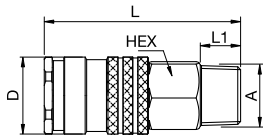
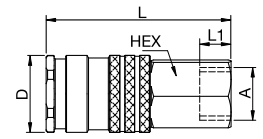
	Connection A	HEX mm	L mm	L1 mm	D mm	Version	Part Number
 <p>Male Thread</p>	G 1/2	22	54	13	27	AISI 316	1800KAAW21EVX
 <p>Female Thread</p>	G 3/8	22	54	10	27	AISI 316	1800KAIW17EVX
	G 1/2	24	55	10	27	AISI 316	1800KAIW21EVX



Plugs – without valve

Series 1800KA

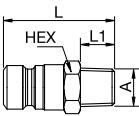
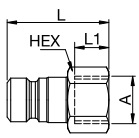
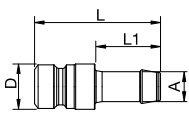
	Connection A	HEX mm	L mm	L1 mm	D mm	Version	Part Number
 <p>Male Thread</p>	G 3/8	19	36	10		AISI 316	1800SFAW17EXX
 <p>Female Thread</p>	G 3/8	22	36	10		AISI 316	1800SFIW17EXX
 <p>Hose Barb</p>	6 mm		44	23	16	AISI 303	1800SFTF06RXX



Couplings – with valve

Series 1800KB

	Connection A	HEX mm	L mm	L1 mm	D mm	Version	Part Number
<p>Male Thread</p>	G 1/2	22	54	10	27	AISI 316	1800KBAW21EVX
<p>Female Thread</p>	G 3/8	22	54	9	27	AISI 316	1800KBIW17EVX
	G 1/2	24	55	9	27	AISI 316	1800KBIW21EVX







Plugs – with valve

Series 1800KB

	Connection A	HEX mm	L mm	L1 mm	D mm	Version	Part Number
<p>Female Thread</p>	G 3/8	22	49	10		AISI 316	1800SBIW17EVX
	G 1/2	25	50	9		AISI 316	1800SBIW21EVX

Cross-Reference-List

Connection	Thread	Rectus Part Number old	Tema Part Number old	Part Number new	Page
 Couplings – with valve					
Male Thread	G 1/2		1800 ARV	1800KAAW21EVX	161
Female Thread	G 3/8		1800 RV	1800KAIW17EVX	161
	G 1/2		1800 BRV	1800KAIW21EVX	161
 Plugs – without valve					
Male Thread	G 3/8		18210 R	1800SFAW17EXX	161
Female Thread	G 3/8		18410 R	1800SFIW17EXX	161
Hose Barb	6 mm		18006 RF	1800SFTF06RXX	161
 Couplings – with valve					
Male Thread	G 1/2		1800 NARV	1800KBAW21EVX	162
Female Thread	G 3/8		1800 NRV	1800KBIW17EVX	162
	G 1/2		1800 NBRV	1800KBIW21EVX	162
 Plugs – with valve					
Female Thread	G 3/8		18410 RV	1800SBIW17EVX	162
	G 1/2		18422 RV	1800SBIW21EVX	162



Coupling series in sizes 1/8" to 1" with plug profile compliant with ISO 7241-1 series B. Particularly suited to use with liquid media. Coupling system with two-hand operation, i.e. both hands are required when coupling/uncoupling. The coupling series stands out for its high flow rates against a low pressure drop.

Working Temperature*

-15°C up to +200°C (FKM) depending on the medium.

* For temperatures below -15°C and over +200°C and depending on the medium, other seal variants (EPDM, FFKM) are available.

Series 70 with additional end connections available on request.



Working Pressure**

see charts

** maximum static working pressure with design factor 4 to 1.

Material

Coupling: AISI 303 / AISI 316 L

Plug: AISI 303 / AISI 316 L

Seals: FKM

Technical Description

Dead space volume: 0,45 ml

Connecting Force 0 bar: 55 N

Connecting Force 6 bar: 140 N

Vacuum Coupling: 96% *

Vacuum Plug: 96% *

Vacuum connected: 96% *

* Except for series 76, which is not suitable for vacuum applications.

Other designs in series 70

The following other designs can be found from page:

- ▶ Brass / Steel P. 126
- ▶ Thermoplastic P. 190

Interchangeability

- ISO 7241-1 Series B

Flow diagrams Water

71KB - 1/8"

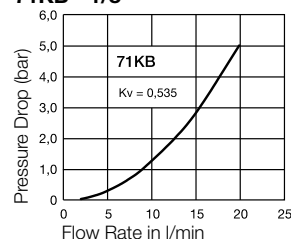

72KB - 1/4"

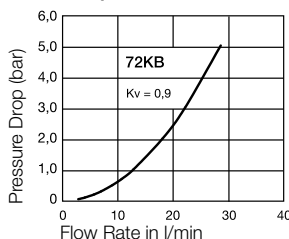

73KB - 3/8"

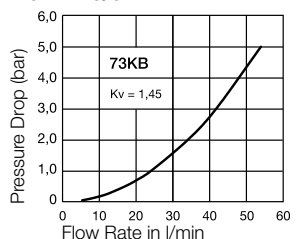

74KB - 1/2"

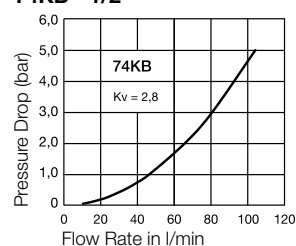

75KB - 3/4"

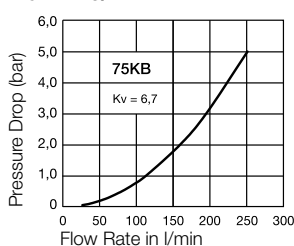

76KB - 1"

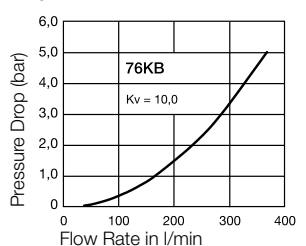



Couplings – with valve

Series 70KB

Size	Connection A	HEX mm	HEX1 mm	L mm	L1 mm	L2 mm	D mm	B mm	Working Pressure max. / bar	Version	Part Number
1/8	G 1/8	14		48,5	7		25		250	AISI 303	71KBIW10RVX
1/8	G 1/8	14		48,5	7		25		250	AISI 316 L	71KBIW10EVX
1/4	G 1/4	19		57,5	10		29		250	AISI 303	72KBIW13RVX
1/4	G 1/4	19		57,5	10		29		250	AISI 316 L	72KBIW13EVX
3/8	G 3/8	22		64	11,5		35		250	AISI 303	73KBIW17RVX
3/8	G 3/8	22		64	11,5		35		250	AISI 316 L	73KBIW17EVX
1/2	G 1/2	27		76	16		44,5		250	AISI 303	74KBIW21RVX
1/2	G 1/2	27		76	16		44,5		250	AISI 316 L	74KBIW21EVX
3/4	G 3/4	34		96	24		55		160	AISI 303	75KBIW26RVX
3/4	G 3/4	34		96	24		55		160	AISI 316 L	75KBIW26EVX
1	G 1	41		105,5	24		62		100	AISI 303	76KBIW33RVX
1	G 1	41		105,5	24		62		100	AISI 316 L	76KBIW33EVX

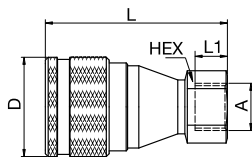

Female Thread



Plugs – with valve

Series 70KB

Size	Connection A	HEX mm	HEX1 mm	L mm	L1 mm	L2 mm	D mm	B mm	Working Pressure max. / bar	Version	Part Number
1/8	G 1/8	14		29,5	7				250	AISI 303	71SBIW10RVX
1/8	G 1/8	14		29,5	7				250	AISI 316 L	71SBIW10EVX
1/4	G 1/4	19		35	10				250	AISI 303	72SBIW13RVX
1/4	G 1/4	19		35	10				250	AISI 316 L	72SBIW13EVX
3/8	G 3/8	22		39	11,5				250	AISI 303	73SBIW17RVX
3/8	G 3/8	22		39	11,5				250	AISI 316 L	73SBIW17EVX
1/2	G 1/2	27		48	16				250	AISI 303	74SBIW21RVX
1/2	G 1/2	27		48	16				250	AISI 316 L	74SBIW21EVX
3/4	G 3/4	36		60	24				160	AISI 303	75SBIW26RVX
3/4	G 3/4	36		60	24				160	AISI 316 L	75SBIW26EVX
1	G 1	41		65	24				100	AISI 303	76SBIW33RVX
1	G 1	41		65	24				100	AISI 316 L	76SBIW33EVX

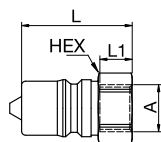

Female Thread

RectuChem / RectuPom

Chemical Resistance

RectuChem

This quick connect coupling system made of polyvinyl fluoride (PVDF) has been designed for increased resistance of chemicals. The stable spring made of high quality stainless steel guarantees a secure connection and permanent functionality.

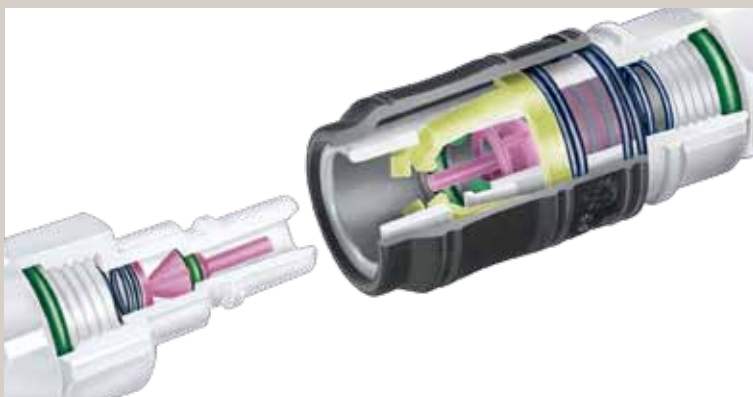

RectuChem+

This quick connect coupling system completely made of solid plastic is extremely resistant to all organic and mineral media. The resistance of the sealing materials, the PVDF base material and the spring fittings made of PEEK offer virtually unlimited application possibilities. The system is excellently suited for media that must not be contaminated by metal radicals.



RectuPom

The tried and tested, quick connect coupling system made of thermoplastic polymer stands out for its unparalleled, high mechanical strength and outstanding resistance to liquids and high temperatures. The plug is automatically locked in position when pushed in. To disconnect, simply pull back the sleeve.

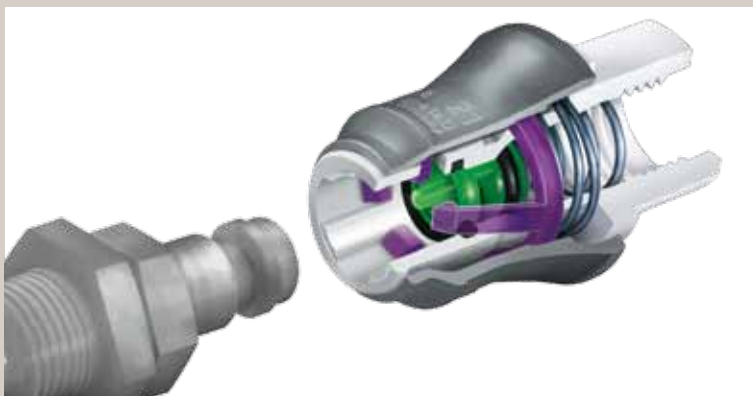

The following details are non-binding guide values to determine chemical resistance.
If in doubt, please ask your consultant.

RectuChem (PVDF) chemical resistance

1 = resistant

2 = limited resistance

3 = not resistant

Chemicals	Temperature					
	20°C	50°C	70°C	100°C	110°C	120°C
Acetaldehyde	3					
Acetanhydride	3	3	3			
Acetic acid (100%)	1	1	2	3	3	
Acetic acid (50%)	1	1	1	1	1	
Acetic acid (80%)	1	1	1	1		
Acetone	3	3				
Acetone (50% water)	2	2	3			
Acetone nitrile	1	1	2			
Acetophenone	1	2	3	3		
Acetyl acetone	3			3		
Acetyl chloride	3	3				
Acryl nitrile	1	2				
Adipic acid, diluted	1	1	1			
Allyl chloride	1	1	1	1		
Aluminium chloride	1	1	1	1	1	1
Aluminium chloride (50%)	1	1	1			
Aluminium fluoride	1	1	1	1	1	1
Aluminium fluoride (50%)	1	1	1			
Aluminium hydroxide	1	1	1	1	1	1
Aluminium nitrate	1	1	1	1	1	1
Aluminium nitrate (50%)	1	1	1			
Aluminium potassium sulphate	1	1	1	1	1	1
Aluminium sulphate	1	1	1			
Ammonia (30%)	1	1	1	1		
Ammonia, anhydrous	1	1	1	1	1	1
Ammonium aluminium sulphate	1	1	1	1	1	1
Ammonium carbonate	1	1	1	1	1	1
Ammonium chloride	1	1	1	1	1	1
Ammonium chloride (50%)	1	1	1	1	1	1
Ammonium fluoride	1	1	1	1	1	1
Ammonium fluoride (20%)	1	1	1	1	1	1
Ammonium hydroxide	1	1	1	1	1	1
Ammonium nitrate	1	1	1	1	1	1
Ammonium nitrate (50%)	1	1	1	1	1	1
Ammonium phosphate	1	1	1	1	1	1
Ammonium phosphate (50%)	1	1	1	1	1	1
Ammonium sulphate	1	1	1	1	1	1
Ammonium sulphate (50%)	1	1	1	1	1	1
Ammonium sulphide	1	1	1	1	1	1
Amyl acetate	1	1	2	3	3	
Amyl alcohol	1	1	1	1	1	1
Amyl chloride	1	1	1	1	1	1
Amyl chloride (50%)	1	1	1	1	1	1
Aniline	1	2	2	3		
Antimony trichloride	1					
Aqua regia			3			
Arsenic acid	1	1	1	1	1	1
Barium carbonate	1	1	1	1	1	1
Barium chloride	1	1	1	1	1	1
Barium hydroxide	1	1	1	1	1	1
Barium sulphide	1	1	1	1	1	1
Benzaldehyde	2	2	3			
Benzene	1	2	2			

Chemicals	Temperature					
	20°C	50°C	70°C	100°C	110°C	120°C
Benzene-sulphonic acid	1	3				
Benzoic acid	1	1	1	1	1	1
Benzoic acid methyl ester	1		3			
Benzyl alcohol	1	1	1	1	1	1
Benzyl chloride	1	2	2	3	3	3
Borax	1	1	1	1	1	1
Boric acid	1	1	1	1	1	1
Bromic acid	1	1	1	1	1	
Bromine water	1	1	1	1		
Bromine, dry	1	1	1			
Butadiene	1	1	1	1		
Butene	1	1	1	1	1	1
Butyl acetate	1	2	3	3		
Butyl acrylate	1	2	3	3		
Butyl glycol	1	1	1	1	1	1
Butyl phenol	1	1	1	1		
Butyric acid	1	1	1	1	1	
Calcium carbonate	1	1	1	1	1	1
Calcium chlorate	1	1	1	1	1	1
Calcium chloride	1	1	1	1	1	1
Calcium disulphate	1	1	1	1	1	1
Calcium hydrogen sulphite	1	1	1	1	1	1
Calcium hydroxide	1	1	1	1	1	1
Calcium hypochlorite	1	1	1	1	1	1
Calcium nitrate (50%)	1	1	1	1		
Calcium nitrate	1	1	1	1	1	1
Calcium sulphate	1	1	1	1	1	1
Capric acid	1	1	1			
Caprylic acid	1	1	1	2		
Carbon dioxide, wet or dry	1	1	1	1	1	1
Carbon disulphide	1					
Carbon tetrachloride	1	1	1	1	1	1
Caustic soda (10%), Caustic soda (30%)	1	1	1	1		
Caustic soda (50%)	1	1	1	3		
Chlorine (50%)	1	1	1	1		
Chlorine dioxine (15%)	1	1	1			
Chlorine, dry	1	1	1	1		
Chlorine, wet	1	1	1	1		
(Mono-)chloroacetic acid (50%)	1	1	1	1		
(Mono-)chloroacetic acid (100%)	1	1	1	1		
Chlorobenzene	1	1	1	2		
Chlorodifluoromethane	1	1	1	1		
Chloroform	1	1	1	1		
Chlorosulphonic acid	1	1				
Chromic acid (50%)	1	1	2			
Chromyl chloride	1	1				
Citric acid (50%)	1	1	1	1	1	1
Coconut oil	1	1	1	1	1	1
Coke oven gas	1	1	1	1	1	1
Copper chloride	1	1	1	1	1	1
Copper cyanide	1	1	1	1	1	1
Copper fluoride	1	1	1	1	1	1
Copper nitrate	1	1	1	1	1	1

Chemicals	Temperature					
	20°C	50°C	70°C	100°C	110°C	120°C
Copper sulphate	1	1	1	1		
Corn oil	1	1	1	1	1	1
Credonaldehyde	1	1	1	1	1	1
Crude oil	1	1	1	1	1	1
Cyclohexane	1	1	1	1	1	1
Cyclohexanol	1	1	1	2		
Cyclohexanone	1	3	3	3		
Dextrine	1	1	1	1	1	
Diacetone alcohol	1	2	3	3		
Dichlorodiflourmethane	1	1	1	1		
Diesel fuel	1	1	1	1	1	1
Diethyl ether	1	2				
Diethylamine	1	3	3			
Diethylenetriamine	1	1	2	3		
Diglycolic acid	1					
Diisobutyl ketone	1	1	1	1		
Diisopropyl ether	1	1				
Dimethyl amine	3	3	3	3		
Dimethyl aniline	1	2	3	3	3	
Dimethyl formamide			3			
Dimethyl phthalate	1	2	3	3		
1, 4-Dioxane	3	3	3			
Epichlorohydrine	3	3				
Ethyl acetate	1	2	3	3		
Ethyl acrylate	1	2	3	3		
Ethyl alcohol	1	1	1	1	1	1
Ethyl chloride	1	1	1	1	1	1
Ethylene bromide (1,2-Dibromoethane)	1	1	1	1	1	1
Ethylene chloride (1,2-Dichloroethane)	1	1	1	1	1	1
Ethylene chlorohydrine	1	2	3	3		
Ethylene diamine	3	3				
Ethylene glycol	1	1	1	1	1	1
Ethylene oxide	1	1				
Fats (triglycerides of long or medium chain fatty acids)	1	1	1	1		
Fatty acids (long chain)	1	1	1	1	1	1
Fatty acids (medium chain)	1	1	1			
Fluoric acid (70%), hydrogen fluoride (100%)	1	1	1	1		
Fluoric acid (hydrogen fluoride) (35%)	1	1	1	1	1	1
Fluorine	1					
Formaldehyde (37%, Formalin, Wz)	1	1				
Formic acid	1	1	1	1	1	1
Fuel oil (EL)	1	1	1	1	1	1
Furane	3	3				
Furfurol	2	3	3	3		
Gallic acid	1	2				
Gear oil ARAL Energol HL 32	1	1				
Gear oil ARAL Montanol GM 220	1	1	1			
Gear oil BP Energol H-PC 220	1	1	1			
Gear oil Shell Tellus oil 32	1	1	1			
Gear oil Shell Tonna oil T 220	1	1	1			
Glucose	1	3				
Glycerin	1	1	1	1	1	1
1, 2-Glycol	1	2	2	3	3	3
Glycolic acid (hydroxyacetic acid)	1	1	1	1	1	1
Heptane	1	1	1	1	1	1
Hexamethyldisilazane (HMDS)	1	1	1	1	1	1
Hexane	1	1	1			
Hydrazine UDMH 50/50	1	1	1	1	1	
Hydrobromic acid	1	1	1	1	1	1
Hydrochloric acid (20%), hydrochloric acid (conc.)	1	1	1	1	1	1

Chemicals	Temperature					
	20°C	50°C	70°C	100°C	110°C	120°C
Hydrochloric acid (gaseous)	1	1	1	1	1	1
Hydrogen	1	1	1	1	1	1
Hydrogen cyanide	1	1	1	1	1	1
Hydrogen peroxide (30%)	1	1	1	1	1	1
Hydrogen peroxide (90%)	1					
Hydrogen phosphide	1	1				
Hydrogen sulphide, wet or dry	1	1	1	1	1	1
Hydroiodic acid (48% + 12%J2)	1	1	1	1	1	1
Hypochlorous acid	1	1	1	1	1	1
Iodine, wet; Iodine, dry	1	1	1	1	1	1
Iodoform	1	1	1	1		
Iron (II) chloride	1	1	1	1	1	1
Iron (II) nitrate, Iron (III) nitrate	1	1	1	1	1	1
Iron (II) sulphate, Iron (III) sulphate	1	1	1	1	1	1
Iron (III) chloride (50%)	1	1	1	1	1	1
Iron (III) sulphate (50%)	1	1	1	1		
Isooctane	1	1	1	1		
Jet fuel IP4 and IP5	1	1	1	1		
Kerosine	1	1	1	1		
Lactic acid	1	2	3	3		
Lauric acid	1	1	1	1	1	1
Lauryl chloride	1	1	1			
Lead acetate	1	1	1	1	1	1
Lead tetraethyl	1	1	1	1	1	1
Linoleic acid	1	1	1	1		
Linseed oil	1	1	1	2		
Magnesium carbonate	1	1	1	1		
Magnesium chloride	1	1	1	1		
Magnesium hydroxide	1	1	1	2		
Magnesium nitrate	1	1	1	1		
Magnesium sulphate	1	1	1			
Maleic acid	1	1	1	1		
Mercuric chloride	1	1	1	1	1	1
Mercuric cyanide	1	1	1	1	1	1
Mercuric nitrate	1	1	1	1	1	1
Mercury	1	1	1	1	1	1
Methane	1	1	1	1		
Methane sulphonic acid (50%)	1	1	1	1		
Methyl alcohol	1	1				
Methyl bromide	1	1	1	1	1	1
Methyl chloride	1	1	2			
Methyl ethyl ketone	3	3	3	3		
Methyl isobutyl ketone	1	2	3	3		
Methylene chloride	2	2				
Milk	1	1	1	1		
Mineral oil	1	1	1	1	1	
Mineral oil	1	1	1	1	1	1
Monoethanolamine	3	3				
Morpholine	2	3	3			
N, N-Dimethyl acetamide			3			
Naphtha	1	1	1	1	1	1
Naphthalene	1	1	1	2		
Natural gas	1	1	1	1	1	1
n-Butanol	1	1	1	1	1	1
n-Butyl amine	3	3				
n-Butyl bromide	1	1	1	1	1	1
n-Butyl chloride	1	1	1	1	1	1
n-Butyl mercaptane	1	1	1	1	1	1
Nickel chloride	1	1	1	1	1	1
Nickel nitrate	1	1	1	1	1	1

Chemicals	Temperature					
	20°C	50°C	70°C	100°C	110°C	120°C
Nickel sulphate	1	1	1	1	1	1
Nicotine	1	2	2			
Nicotinic acid	1	1	1	1	1	1
Nitrating acid	1	1	2			
Nitric acid (15%), Nitric acid (30%)	1	1	1	1		
Nitric acid (65%)	1	1	1			
Nitric acid (fuming)	2	2				
Nitrobenzene	1	2	3			
Nitrogen dioxide	1	1	1	1		
Nitromethane	2	3				
Nitrous acid	1	1	1	1		
N-Methylpyrrolidone			3			
Octane	1	1	1	1	1	1
Octene	1	1	1	1	1	1
o-Dichlorobenzene						
Oil (triglyceride)	1	1	1	1		
Oleic acid	1	1	1	1	1	1
Oleum	3					
Oxalic acid	1	1	2	3		
Oxygen	1	1	1	1	1	1
Ozone	1	1	1	1	1	1
Palmitic acid	1	1	1	1	1	1
Paraldehyde	1	1	1			
Perchloroethylene	1	1	1	1	1	1
Perchloric acid (10%)	1	1	1	1		
Perchloric acid (72%)	1	1				
Petrol (leaded)	1	1	1	1	1	1
Petrol (unleaded)	1	1	1	1	1	1
Phenol (10%)	1	1	1	1		
Phenol (100%)	1	1	1	2		
Phenylhydrazine	1	1				
Phosphoric acid (30%)	1	1	1	1	1	1
Phosphoric acid (85%)	1	1	1	1	1	
Phosphorous pentoxide	1	1	1	1		
Phosphorous trichloride	1	1	1	1		
Phthalic acid	1	1	1	1		
Picric acid	1					
Potassium bromide	1	1	1	1	1	1
Potassium carbonate	1	1	1	1	1	1
Potassium chlorate	1	1	1	1	1	
Potassium chloride	1	2	3	3		
Potassium cyanide	1	2	3	3		
Potassium dichromate	3	3				
Potassium hydroxide	1	2	2	3		
Potassium nitrate	1	1	1	1	1	1
Potassium permanganate	1	1	1	1	1	1
Potassium sulphate	1	1	1	1	1	1
Potassium sulphide	1	1	1	1	1	1
Potassium terrocyanide	3	3				
Propane	1	1	1	1	1	1
Propanol	1	1	2	3		
Propylene carbonate			3			
Propylene oxide	3					
Pyridine	3	3	3			
Pyrogalllic acid	1	1				
Salicylic acid	1	1	1	1		
sec-Butanol	1	1	1	1	1	1
sec-Butyl amine	3	3				
Silicon tetrachloride	1					
Silver cyanide	1	1	1	1	1	1

Chemicals	Temperature					
	20°C	50°C	70°C	100°C	110°C	120°C
Silver nitrate	1	1	1	1	1	1
Sodium acetate	1	1	1	1	1	1
Sodium benzoate	1	1	1	1	1	1
Sodium bicarbonate (Sodium hydrogen carbonate)	1	1	1	1	1	1
Sodium bisulphate (Sodium hydrogen sulphate)	1	1	1	1	1	1
Sodium bisulphite (Sodium hydrogen sulphite)	1	1	1	1	1	1
Sodium bromide	1	1	1	1	1	1
Sodium carbonate	1	1	1	1	1	1
Sodium carbonate (40%)	1	1	1			
Sodium chlorate	1	1	1	1	1	1
Sodium chloride	1	1	1	1	1	1
Sodium cyanide	1	1	1	1	1	1
Sodium fluoride	1	1	1	1	1	1
Sodium hypochloride	1	1	1	1	1	1
Sodium nitrate	1	1	1	1	1	1
Sodium nitrite	1	1	1	1	1	1
Sodium peroxide	1	1	1	1	1	1
Sodium phosphate	1	1	1	1	1	1
Sodium silicate	1	1	1	1	1	1
Sodium sulphate	1	1	1	1	1	1
Sodium sulphide	1	1	1	1	1	1
Sodium sulphite	1	1	1	1	1	1
Sodium thiosulphate	1	1	1	1	1	1
Stearic acid	1	1	1	1	1	1
Sulphur	1	1	1	1	1	1
Sulphur chloride	1					
Sulphur dichloride	1					
Sulphur dioxide	1	1	1	1		
Sulphur trioxide	3	3				
Sulphuric acid (50%)	1	1	1	1	1	
Sulphuric acid (60%)	1	1	1	1		
Sulphuric acid (80%)	1	1	1	1	1	2
Sulphuric acid (95%)	1	1	2	3		
Sulphuric acid (fuming/monohydrate)	3	3				
Sulphurous acid	1	1	1	1		
Synthesis gas	1	1	1	1	1	1
Tall oil	1	1	1	1	1	1
tert-Butanol	1	1	1	1	1	1
tert-Butyl amine	1	2	2	3		
Tetrachloroethylene	1	1	1	2		
Tetrahydrofuran	2	3				
Tetramethyl ammonium hydroxide (50%)	1	1	1	1		
Thionyl chloride	1	2				
Titanium tetrachloride	1	1				
Toluol	1	1	1	2		
Tributyl phosphate	1	1	1	1		
Trichloroacetic acid	1	2	3	3		
1.1.1-Trichloroethane	1	1	2			
Trichloroethylene	1	1	1	1	1	1
Trichlorofluoromethane	1	1	1	1		
Triethyl amine	1	1	2	3		
Urea (50%)	1	1	1	1	1	1
Vinyl acetate	1	1	1	1	1	1
Water, seawater	1	1	1	1	1	1
Xylol	1	1	1			
y-Butyrol acetone			3			
Zinc chloride (50%)	1	1	1	1	1	1
Zinc nitrate (50%)	1	1	1	1	1	1
Zinc sulphate (50%)	1	1	1	1	1	1

RectuPom chemical resistance

1 = resistant
2 = limited resistance
3 = not resistant

Weight increase < 3% or weight loss < 0.5% and/or decrease in tensile strength < 15%
Weight increase 3 - 8% or weight loss 0.5 - 3% and/or decrease in tensile strength 15 - 30%
Weight increase > 8% or weight loss > 3% and/or decrease in tensile strength > 30%

Chemicals	Temperature		Chemicals	Temperature		Chemicals	Temperature	
	20°C	50°C		20°C	50°C		20°C	50°C
Acetic acid (10%)*	1	1	Glycerin	1	1	Sodium bisulphite lye (pH 4.5)	3	3
Acetic acid (80%)	2	3	Glycol	1	1	Sodium carbonate (10%)	1	1
Acetone	1	2	Glycol/distilled water 48 : 52	1	1	Sodium chloride	1	1
Acetylene tetrabromide (10%)*	2	3	@Grisiron GBF 1 (5g to 100g H2O)	1	1	Sodium hydroxide (sodium lye, caustic soda)	1	1
Ammonia (10%)	1	1	Hydrochloric acid (10%)	3	3	Sodium hypochlorite (bleaching sol. about 12.5% active chlorine)	2	3
Ammonia (conc.)	1	1	Hydrogen peroxide (30%)*	1	3	Sodium nitrate @Hoechst (10%, pH 0.8)	1	1
Ammonium sulphate @Hoechst (10%, pH 5.8)	1	3	Hydroxycitronellal	1	1	Sodium o-phosphate, primary (10%)	1	1
Benzol	2	2	Ink (@Pelikan ink, blue-black)	1	3	Sodium o-phosphate, sec. (10%)	1	1
Butanol	1	1	Iron chloride (10%)	2	3	Sodium o-phosphate, tert. (10%)	1	1
Butyl acetate	1	2	Isopropyl alcohol	1	1	Soya oil	1	1
Butyraldehyde	2	2	JP 1 fuel (Shell)	1	1	Sulphur dioxide gas	3	3
Butyric acid (1%)*	1	1	JP 4 fuel (Shell)	1	1	Sulphuric acid (10%)*	1	3
Butyric acid (98)	2	2	Lactic acid (10%)*	1	2	Sulphuric acid (50%)	3	3
Calcium ammonium nitrate	1	1	Lactic acid (90%)*	1	3	Tetrahydrofuran	2	2
Calcium chloride (10%)	1	1	Lavender oil, finest	1	1	@Tetralin (Henkel)	1	2
Calcium nitrate @Hoechst (pH 6.4) (10%)	1	1	Lemongrass oil	1	1	Thiophene	2	2
Cananga oil	1	1	Methanol	1	1	Toluol	1	1
Carbon disulphide	1	1	Methyl acetate	2	2	Transformer oil (@Univolt 36, Esso)	1	1
Carbon tetrachloride	1	2	Methyl bromide	3	3	Trichlorethylene	2	2
CFC (partially halogenated)	3	3	Methyl ethyl ketone	2	2	Urine	1	1
CFC (perhalogenated)	1	1	Methyl glycol	2	2	Water, distilled	1	1
Chlorinated lime (approx. 10%)	3	3	Methyl glycol acetate	2	3	Xylol	1	1
Chlorobenzene	2	2	Methylene bromide	3	3			
Chloroethyl (DAB 6)	1	2	Methylene chloride, technical	3	3			
Chloroform	3	3	Methylisobutylketone	1	1			
Chromic acid (3%)	2	2	Methylisopropylketone	1	1			
@Complezal Type Blue 12+12+17+2 (10%, pH 5.8)	1	1	Mineral oil	1	1			
Citric acid (10%)	1	3	Mobil oil HD SAE 20 after 3000 km	1	1			
Clophen A 60 (Bayer)	1	1	Mobil oil SAE 20	1	1			
Coffee (@Nescafe)	1	1	Natural gas	1	1			
Copper sulphate (10%)	1	1	n-Hexane	1	1			
Developer solution 1:50 (pH 10.9) (@Rodinal Agfa)	1	1	Nickel sulphate (10%)	1	1			
Developer solution 1:100 (pH 10.4) (@Rodinal Agfa)	1	1	Nitric acid (10%)	3	3			
Dibutyl phthalate	1	1	Nitrogen phosphate @Hoechst (10%, pH 5.1)	1	1			
Diesel oil	1	1	Nitrous gases	3	3			
Dimethyl phthalate	1	2	Normal car petrol	1	1			
Diocetyl sebacate	1	1	Oil of cloves	1				
Dioxane	2	2	Olive oil	1	2			
Engine oil BP HP 20	1	1	Ozone	3	3			
Engine oil SAW 40 (Caltrex)	1	1	Peat water (pH 3.7)	1	1			
Ethanol (96%)	1	1	Perchloroethylene	1	2			
Ether (DAB 6)	1	1	@Persil 59 (5%, Henkel)	1	1			
Ethyl acetate	2	2	Petrol (BP 100-140°C)	1	1			
Ethyl glycol	1	2	Petrol with 15 ... 20% methanol	1	1			
Fixing bath solution (pH 5.4)	1	2	Petrol/benzol mixture (super grade petrol)	1	1			
Formaldehyde (40%)	1	1	Petroleum	1	1			
Formic acid (10%)*	1	3	Phenol	3	3			
Fuel oil EL	1	1	Phosphoric acid (25%)	1	3			
Galbanum resin	1		Potassium hydroxide (potash lye, caustic potash)	1	1			
@Genantin drinking water 1:1 (+1% @Donax C, Shell)	1		Potassium permanganate (10%)*	1	1			
Glacial acetic acid	2	3	Seawater (North Sea)	1	1			
			Sodium bicarbonate (10%)	1	1			

* Because of the acid or oxidizing nature of these chemicals, practical trials are recommended before prolonged contact with Rectus products.

The results were obtained using injection-moulded, 1 mm thick test samples after a test duration of 60 days. During this, the test samples were under the influence of no external tension.

Resistance table for O-rings

1 = resistant
2 = limited resistance
3 = not resistant

Chemicals	Seals		
	NBR	EPDM	FKM
Acetone	3	1	3
Acetylene gas	1	1	1
Alcohol	2	1	1
Alkalis	1	1	3
Aluminium sulphate	1	1	1
Ammonia, liquid	2	1	2
Ammonium hydroxide	1	1	3
Aniline	3	2	1
Anol	2	3	1
Argon gas	1	1	1
ATE Brake fluid	3	1	3
Beer	1	1	1
Benzol	2	3	1
Borax	1	1	1
Boric acid	1	1	1
Brine lye	3	3	1
Butane gas	1	2	1
Butanone	3	1	3
Butyl benzoate	3	1	1
Camphor	1	3	2
Carbolic acid	3	3	1
Carbon dioxide	1	1	1
Carbonic acid gas	1	1	1
Caustic soda	3	3	1
Chlorine	3	1	2
Chromic acid	3	2	1
Citric acid	2	1	1
Citrus oils	2	1	3
Coal gas	3	3	1
Coconut oil	1	3	1
Coke oven gas	1	3	3
Cooling water	2	1	1
Cresol	3	3	1
Diesel oil	1	3	1
Dioxane	3	2	3
Diphenyl	3	3	1
Dodecanol	2	2	2
Ether	1	2	2
Ethyl alcohol	2	1	1
Ethyl alcohol	2	1	2
Ethylene gas	1	3	1
Fatty acids	2	3	2
Fish oil	1	2	1
Fluorine	3	3	2
Formaldehyde	2	2	1
Formic acid	3	1	1
Freon 11	1	3	2
Freon 12	2	2	2
Fuel oil	1	3	1
Gallic acid	2	2	1
Gasoline	2	3	1
Gear oil	1	3	1
Glucose	1	1	1
Glycerin	1	1	1

Chemicals

Seals

	NBR	EPDM	FKM
Glycol	1	1	3
Helium gas	1	1	1
Hexane	1	3	1
Hot air up to 120°C	3	1	1
Hot air up to 200°C	3	3	1
Hydraulic oil	3	1	1
Hydrocarbon	1	3	1
Hydrogen	1	3	1
Hydrogen cyanide	2	2	1
Hydrogen sulphide, dry	3	2	1
Hydrosulphide	2	1	1
Iodine, Iodine tincture	2	2	1
Iron chloride	1	1	1
Iron nitrate	1	1	1
Isooctane	1	3	1
Lanolin	1	3	1
Lead acetate	1	2	1
Linseed oil	1	3	1
Lubricating oil	1	2	1
Magnesium sulphate (Epsom salt)	2	1	1
Mains gas	1	3	1
Mercury (Hydrargyrum)	1	1	1
Methane gas	2	3	1
Methanol	1	1	3
Methy alcohol	3	1	3
Milk	1	2	3
Mine gas	1	3	1
Mineral oil	1	3	3
Mineral oil	1	3	1
Naphtalene (stone oil)	3	3	1
Natural gas	1	2	1
Nitric acid up to 35%	3	1	2
Nitrogen	1	1	1
Nitrous oxide (laughing gas)	1	2	1
Oxygen, cold	2	1	1
Pararffin	1	3	1
Petrol	3	3	1
Petroleum	1	3	1
Potash lye	2	1	2
Potassium cyanide	3	1	1
Potassium sulphate	1	1	1
Propane gas	1	3	1
Salt solutions	1	3	3
Seawater	1	1	1
Silicic acid	1	1	1
Sodium sulphide	3	1	1
Steam up to 150°C	3	1	2
Steam up to 250°C	3	FFKM	2
Synthetic resin thinner (no nitrosolvent)	3	3	1
Tar	1	3	3
Trichloroethylene	3	3	2
Urea	1	1	1
Varnish	2	3	1
Vinegar, acetic acid	3	1	3
Water above 80°C	3	1	1
Water up to 80°C	1	1	1
Water, demineralised	3	1	3
Water, distilled	2	1	1
Xylol	3	3	2
Yeast	1	1	1

Nominal Diameter

3 = 7 mm²

Rectus Series

PPM

Low Pressure



Plastic coupling in nominal diameter 3 mm. The system is particularly suited to use with weak alkalis and acids. The coupling stands out for its light weight and intuitive operation. Secure sealing is indicated by an audible click.

Working Temperature
-40°C up to +82°C

**KF** Straight-Through**Working Pressure****

0-8 bar

** maximum static working pressure with design factor 4 to 1.

Material

Coupling: Acetal (POM), natural color, USP Class VI
Plug: Acetal (POM), natural color, USP Class VI
Seals: NBR

**KA** Single Shut-Off

0-8 bar

Coupling: Acetal (POM), natural color, USP Class VI
Plug: Acetal (POM), natural color, USP Class VI
Seals: NBR

**KB** Double Shut-Off

0-8 bar

Coupling: Acetal (POM), natural color, USP Class VI
Plug: Acetal (POM), natural color, USP Class VI
Seals: NBR

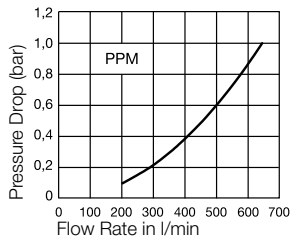
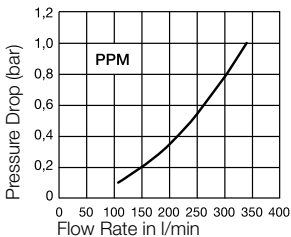
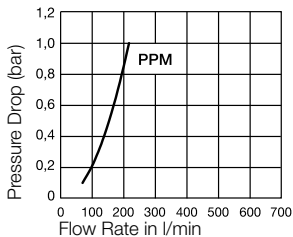
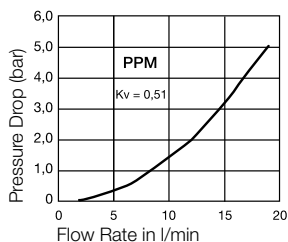
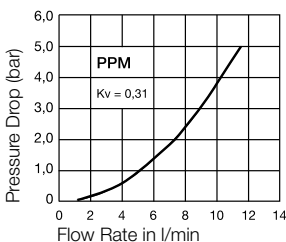
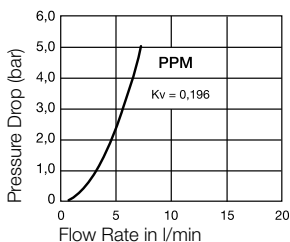
Flow diagrams**Air****Air****Air****Water****Water****Water**



Couplings – without valve

Series PPM

	Connection A	W mm	L mm	H mm	Part Number
 Male Thread	1/8" BSPT	15,7	25,4	20,3	PPM-123-2MBT
	1/4" BSPT	15,7	27,9	20,3	PPM-123-4MBT
 Hose Barb	3,2 mm	15,7	41,9	20,3	PPM-123-2HB
 Panel Mount with Hose Barb	6,0 mm	15,7	45,7	20,3	PPM-123-H4HB



Couplings – with valve

Series PPM

	Connection A	W mm	L mm	H mm	Part Number
 Hose Barb	3,2 mm	15,7	41,9	20,3	PPM-121-2HB
	4,8 mm	15,7	43,7	20,3	PPM-121-3HB
	6,0 mm	15,7	45,7	20,3	PPM-121-4HB
 Panel Mount with Hose Barb	1,6 mm	15,7	38,1	20,3	PPM-121-H1HB
	4,8 mm	15,7	43,7	20,3	PPM-121-H3HB

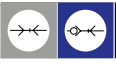

Plugs – without valve

Series PPM

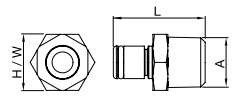
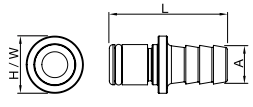
	Connection A	W mm	L mm	H mm	Part Number
 <p>Male Thread</p>	1/8" BSPT	12,4	26,2	12,4	PPM-124-2MBT
 <p>Hose Barb</p>	3,2 mm	12,7	24,6	12,7	PPM-124-2HB
	4,8 mm	12,7	26,4	12,7	PPM-124-3HB
	6,0 mm	12,7	28,4	12,7	PPM-124-4HB



Plugs – with valve

Series PPM

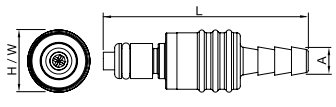
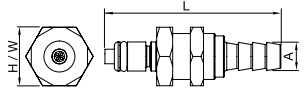
	Connection A	W mm	L mm	H mm	Part Number
 <p>Hose Barb</p>	3,2 mm	14,0	41,9	14,0	PPM-122-2HB
	6,0 mm	14,0	45,7	14,0	PPM-122-4HB
 <p>Panel Mount with Hose Barb</p>	3,2 mm	15,7	43,9	15,7	PPM-122-H2HB

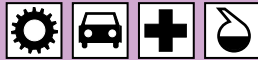
5 = 20 mm²

21

**Other designs in series 21**

The following other designs can be found from page:

- Brass / Steel P. 26
- Stainless Steel P. 140
- Safety P. 210
- Coded Systems P. 234

Mini industrial coupling in plastics POM and PVDF with the world's most popular profile in this nominal diameter. Above average flow performance for liquid and gaseous media.

Coupling system with single-hand operation. This new type of plastic locking system with handy sleeve considerably expands the applications of this series. Two sleeve forms - tapered and cylindrical, where the tapered sleeve form facilitates handling with gloves. The color coding of the coupling and plug offers a guarantee for avoiding mix-ups between media when coupling.

Working Temperature

-20°C up to +80°C (POM)
-20°C up to +120°C (PVDF)
depending on the medium.

Other seal variants are available on request (FKM, EPDM, FFKM).

RectuPOM**RectuChem****Working Pressure****

10 bar (POM, at 20°C)
** maximum static working pressure with design factor 4 to 1.

8 bar (PVDF, at 20°C)

Material

Coupling: POM black
Plug: POM black
Seals: NBR

Coupling: PVDF white
Plug: PVDF white
Seals: FKM

Technical Description

Connecting Force 0 bar (KA): 35 N
Connecting Force 6 bar (KA): 60 N

Connecting Force 0 bar (KA): 35 N
Connecting Force 6 bar (KA): 60 N

Dead space volume (KB): 0,6 ml
Connecting Force 0 bar (KB): 40 N
Connecting Force 6 bar (KB): 80 N

Dead space volume (KB): 0,6 ml
Connecting Force 0 bar (KB): 40 N
Connecting Force 6 bar (KB): 80 N

Valve types

single shut-off



single shut-off



double shut-off

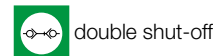

double shut-off

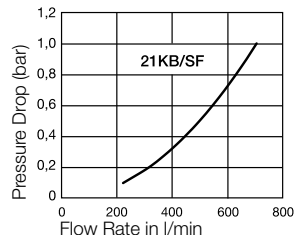
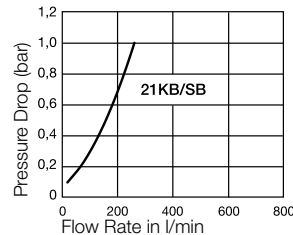
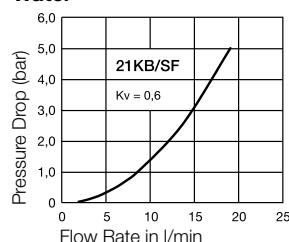
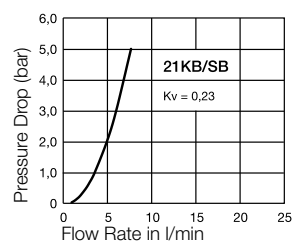
Flow diagrams**Air****Air****Water****Water**



Couplings – with valve

Series 21KB

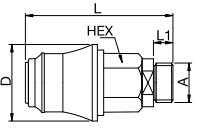
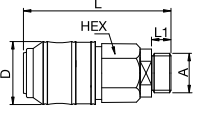
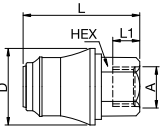
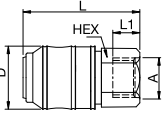
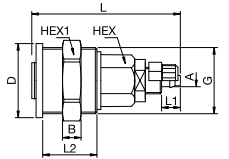
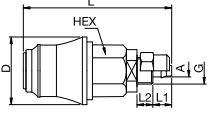
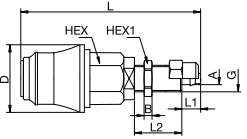
	Connection A	HEX mm	HEX1 mm	L mm	L1 mm	L2 mm	D mm	B mm	G mm	Color Sleeve	Part Number POM	Part Number CHEM
 <p>Male Thread with tapered sleeve</p>	G 1/8	17		50	7		25,5			Standard	21KBAW10DPX	21KBAW10FVX
	G 1/4	17		50	7		25,5			Standard	21KBAW13DPX	21KBAW13FVX
 <p>Male Thread with cylindrical sleeve</p>	G 1/4	17		50	7		21			blue		21KBAW13FVXGB
	G 1/4	17		50	7		21			green		21KBAW13FVXGG
	G 1/4	17		50	7		21			red		21KBAW13FVXGR
	G 1/4	17		50	7		21			yellow		21KBAW13FVXGY
 <p>Female Thread with tapered sleeve</p>	G 1/8	17		53	8		25,5			Standard	21KBIW10DPX	
	G 1/4	17		39	9		25,5			Standard	21KBIW13DPX	21KBIW13FVX
 <p>Female Thread with cylindrical sleeve</p>	G 1/4	17		39	9		21			Standard	21KBIW13DPXG	
	G 1/4	17		39	9		21			blue	21KBIW13DPXGB	21KBIW13FVXGB
	G 1/4	17		39	9		21			green	21KBIW13DPXGG	21KBIW13FVXGG
	G 1/4	17		39	9		21			red	21KBIW13DPXGR	21KBIW13FVXGR
	G 1/4	17		39	9		21			yellow	21KBIW13DPXGY	21KBIW13FVXGY
 <p>Panel Mount for Plastic Hose Connection for Front Panel Installation</p>	4 x 6 mm	17	27	56	7	20,5	28	7	M 25 x 1	Standard	21KBKE06DPX	
	6 x 8 mm	17	27	56	7	20,5	28	7	M 25 x 1	Standard	21KBKE08DPX	
 <p>with Plastic Hose Connection with tapered sleeve</p>	4 x 6 mm	17		56	6	7	25,5		M 10 x 1	Standard	21KBKO06DPX	21KBKO06FVX
	6 x 8 mm	17		56	6	7	25,5		M 12 x 1	Standard	21KBKO08DPX	21KBKO08FVX
 <p>Panel Mount with Plastic Hose Connection with tapered sleeve</p>	4 x 6 mm	17	14	68	7	18	25,5	4	M 10 x 1	Standard	21KBKS06DPX	
	6 x 8 mm	17	17	68	7	18	25,5	4	M 12 x 1	Standard	21KBKS08DPX	

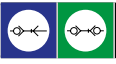

Couplings – with valve

Series 21KB

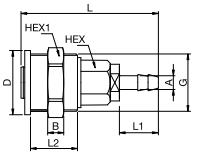
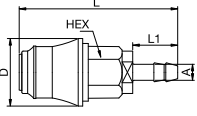
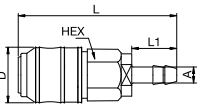
	Connection A	HEX mm	HEX1 mm	L mm	L1 mm	L2 mm	D mm	B mm	G mm	Color Sleeve	Part Number POM	Part Number CHEM
 <p>Panel Mount for Hose Barb for Front Panel Installation</p>	6 mm	17	27	60	17	20,5	28	7	M 25 x 1	Standard	21KBTE06DPX	21KBTE06FVX
 <p>Hose Barb with tapered sleeve</p>	4 mm	17		60	17		25,5			Standard	21KBTF04DPX	21KBTF04FVX
	6 mm	17		60	17		25,5			Standard	21KBTF06DPX	21KBTF06FVX
 <p>Hose Barb with cylindrical sleeve</p>	6 mm	17		60	17		21			Standard	21KBTF06DPXG	
	6 mm	17		60	17		21			blue	21KBTF06DPXGB	
	6 mm	17		60	17		21			green	21KBTF06DPXGG	
	6 mm	17		60	17		21			red	21KBTF06DPXGR	
	6 mm	17		60	17		21			yellow	21KBTF06DPXGY	



Plugs – without valve

Series 21SF

Thermoplastic

Low Pressure

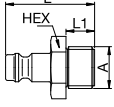
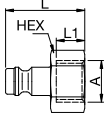
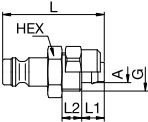
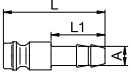
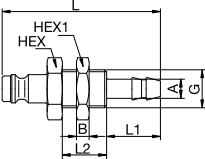
	Connection A	HEX mm	HEX1 mm	L mm	L1 mm	L2 mm	D mm	B mm	G mm	Color Sleeve	Part Number POM	Part Number CHEM
 <p>Male Thread</p>	G 1/8	14		25	7					Standard		21SFAW10FXX
	G 1/4	17		28	9					Standard		21SFAW13FXX
 <p>Female Thread</p>	G 1/8	14		24	8					Standard		21SFIW10FXX
	G 1/4	17		25	9					Standard	21SFIW13DXX	21SFIW13FXX
	G 1/4	17		25	9					blue		21SFIW13FXXB
	G 1/4	17		25	9					green		21SFIW13FXXG
	G 1/4	17		25	9					red		21SFIW13FXXR
	G 1/4	17		25	9					yellow		21SFIW13FXXY
 <p>with Plastic Hose Connection</p>	4 x 6 mm	14		32	7	6			M 10 x 1	Standard	21SFKO06DXX	21SFKO06FXX
	6 x 8 mm	14		32	7	6			M 12 x 1	Standard	21SFKO08DXX	
 <p>Hose Barb</p>	4 mm			32	17					Standard	21SFTF04DXX	21SFTF04FXX
	6 mm			32	17					Standard	21SFTF06DXX	21SFTF06FXX
	6 mm			32	17					blue	21SFTF06DPXB	21SFTF06FVXB
	6 mm			32	17					green	21SFTF06DPXG	21SFTF06FVXG
	6 mm			32	17					red	21SFTF06DPXR	21SFTF06FVXR
	6 mm			32	17					yellow	21SFTF06DPXY	21SFTF06FVXY
 <p>Panel Mount with Hose Barb</p>	4 mm	14	14	50	17	14		4	M 10 x 1	Standard	21SFTS04DXX	
	4 mm	14	14	50	17	14		4	M 10 x 1	blue		21SFTS04FVXB
	4 mm	14	14	50	17	14		4	M 10 x 1	green		21SFTS04FVXG
	4 mm	14	14	50	17	14		4	M 10 x 1	red		21SFTS04FVXR
	4 mm	14	14	50	17	14		4	M 10 x 1	yellow		21SFTS04FVXY
	6 mm	14	17	50	17	14		4	M 12 x 1	Standard	21SFTS06DXX	



Plugs – with valve

Series 21KB

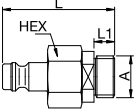
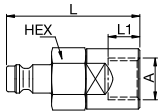
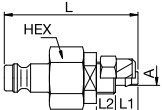
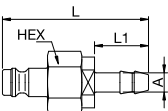
	Connection A	HEX mm	HEX1 mm	L mm	L1 mm	L2 mm	D mm	B mm	G mm	Color Sleeve	Part Number POM	Part Number CHEM
 <p>Male Thread</p>	G 1/8	17		36	7					Standard	21SBAW10DPX	
	G 1/8	17		36	7					blue	21SBAW10DPXB	
	G 1/8	17		36	7					green	21SBAW10DPXG	
	G 1/8	17		36	7					red	21SBAW10DPXR	
	G 1/8	17		36	7					yellow	21SBAW10DPXY	
	G 1/4	17		38	7					Standard	21SBAW13DPX	21SBAW13FVX
	G 1/4	17		38	7					blue		21SBAW13FVXB
	G 1/4	17		38	7					green		21SBAW13FVXG
	G 1/4	17		38	7					red		21SBAW13FVXR
	G 1/4	17		38	7					yellow		21SBAW13FVXY
 <p>Female Thread</p>	G 1/4	17		42	10					Standard	21SBIW13DPX	21SBIW13FVX
 <p>with Plastic Hose Connection</p>	4 x 6 mm	17		42	7	6				Standard	21SBKO06DPX	21SBKO06FVX
	6 x 8 mm	17		42	7	6				Standard	21SBKO08DPX	21SBKO08FVX
 <p>Hose Barb</p>	4 mm	17		46	17					Standard	21SBTF04DPX	
	6 mm	17		46	17					Standard		21SBTF06FVX
	6 mm	17		46	17					blue	21SBTF06DPXB	21SBTF06FVXB
	6 mm	17		46	17					green	21SBTF06DPXG	21SBTF06FVXG
	6 mm	17		46	17					red	21SBTF06DPXR	21SBTF06FVXR
	6 mm	17		46	17					yellow	21SBTF06DPXY	21SBTF06FVXY





Technical Description

Plastic coupling in nominal diameter 6 mm. The system is particularly suited to use with weak alkalis and acids. The coupling stands out for its light weight and intuitive operation. Secure sealing is indicated by an audible click.

Working Temperature

-40°C up to +82°C

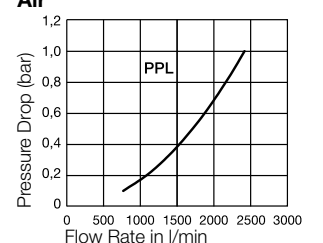
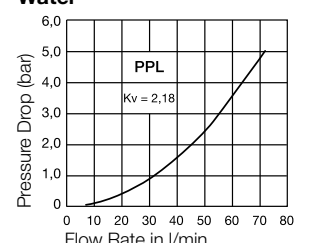
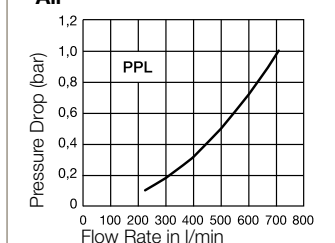
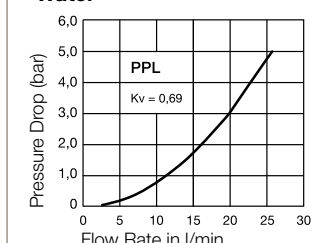
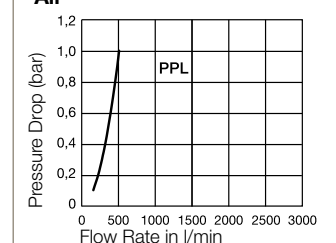
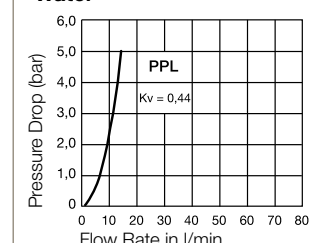
 KF Straight-Through	 KA Single Shut-Off	 KB Double Shut-Off
<p>Working Pressure**</p> <p>0-8 bar ** maximum static working pressure with design factor 4 to 1.</p>	<p>0-8 bar</p>	<p>0-8 bar</p>
<p>Material</p> <p>Coupling: Acetal (POM), natural color, USP Class VI Plug: Acetal (POM), natural color, USP Class VI Seals: NBR</p>	<p>Coupling: Acetal (POM), natural color, USP Class VI Plug: Acetal (POM), natural color, USP Class VI Seals: NBR</p>	<p>Coupling: Acetal (POM), natural color, USP Class VI Plug: Acetal (POM), natural color, USP Class VI Seals: NBR</p>
<p>Flow diagrams</p> <p>Air</p>  <p>Water</p> 	<p>Air</p>  <p>Water</p> 	<p>Air</p>  <p>Water</p> 

Couplings – without valve **Series PPL**

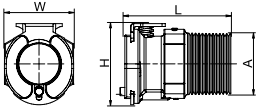
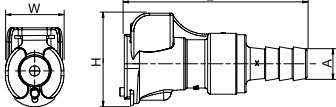
	Connection A	W mm	L mm	H mm	Part Number
 <p>Male Thread</p>	3/8" BSPT	19,1	29,2	23,6	PPL-253-6MBT
 <p>Hose Barb</p>	10 mm	19,1	48,3	23,6	PPL-253-6HB

Couplings – with valve **Series PPL**

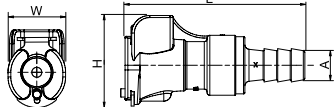
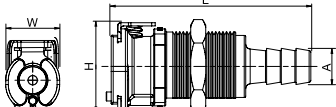
	Connection A	W mm	L mm	H mm	Part Number
 <p>Hose Barb</p>	6 mm	19,1	48,3	23,6	PPL-251-4HB
	10 mm	19,1	48,3	23,6	PPL-251-6HB
 <p>Panel Mount with Hose Barb</p>	10 mm	19,1	48,3	23,6	PPL-251-H6HB

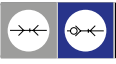

Plugs – without valve

Series PPL

	Connection A	W mm	L mm	H mm	Part Number
<p>Hose Barb</p>	6 mm	15,7	31,8	15,7	PPL-254-4HB
	8 mm	15,7	31,8	15,7	PPL-254-5HB
	10 mm	15,7	31,8	15,7	PPL-254-6HB
<p>Panel Mount with Hose Barb</p>	6 mm	18,8	47,8	18,8	PPL-254-H4HB
	10 mm	18,8	47,8	18,8	PPL-254-H6HB



Plugs – with valve

Series PPL

	Connection A	W mm	L mm	H mm	Part Number
<p>Hose Barb</p>	6 mm	17,8	49,3	17,8	PPL-252-4HB
	10 mm	17,8	46,5	17,8	PPL-252-6HB
<p>Hose Barb 90°</p>	10 mm	15,7	27,9	32,5	PPL-252-C6HB
<p>Panel Mount with Hose Barb</p>	10 mm	18,8	50,8	18,8	PPL-252-H6HB

7 = 38 mm²

48







Coupling series made of POM and PVDF has been developed for use in the medical, chemical, food handling, pharmaceutical and laboratory technology industries. The system is also available in a solid plastic design (RectuChem+). Here the metal springs are replaced by springs made of PEEK, an extremely resistant synthetic material. Coupling system with single-hand operation. The color coding of the coupling and plug offers a guarantee for avoiding mix-ups between media when coupling. The coupling is also available with no valve for a straight-through system.

Working Temperature

-20°C up to +80°C (POM)
-20°C up to +120°C (PVDF)
depending on the medium.

Other seal variants are available on request (FKM, EPDM, FFKM).

RectuPOM	RectuChem	RectuChem+
Working Pressure**		
0-10 bar (POM, at 20°C) ** maximum static working pressure with design factor 4 to 1.	0-8 bar (PVDF, with metal springs)	1-8 bar (PVDF, with PEEK-spring)
Material		
Coupling: POM black Plug: POM black Seals: NBR	Coupling: PVDF white Plug: PVDF white Seals: FKM	Coupling: PVDF white, PEEK-spring Plug: PVDF white, PEEK-spring Seals: FKM
Technical Description		
Connecting Force 0 bar (KA): 40 N Connecting Force 6 bar (KA): 100 N Vacuum Coupling (KA): 87% Vacuum connected (KA): 87%	Connecting Force 0 bar (KA): 40 N Connecting Force 6 bar (KA): 100 N Vacuum Coupling (KA): 87% Vacuum connected (KA): 87%	Connecting Force 0 bar (KA): 40 N Connecting Force 6 bar (KA): 100 N Vacuum Coupling (KA): 87% Vacuum connected (KA): 87%
Dead space volume (KB): 0,9 ml Connecting Force 0 bar (KB): 60 N Connecting Force 6 bar (KB): 120 N	Dead space volume (KB): 0,9 ml Connecting Force 0 bar (KB): 60 N Connecting Force 6 bar (KB): 120 N	Dead space volume (KB): 0,9 ml Connecting Force 0 bar (KB): 60 N Connecting Force 6 bar (KB): 120 N
Valve types		
 single shut-off	 single shut-off	
 double shut-off	 double shut-off	 double shut-off

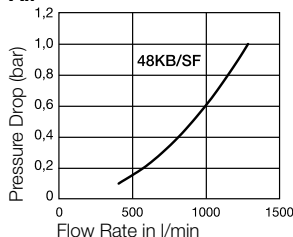
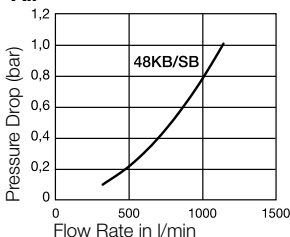
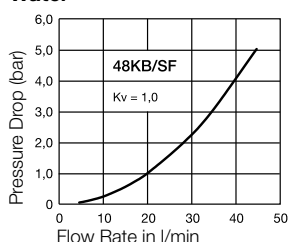
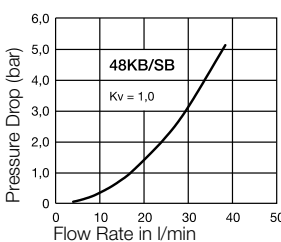
Flow diagrams**Air****Air****Water****Water**



Couplings – with valve

Series 48KB

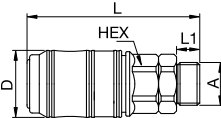
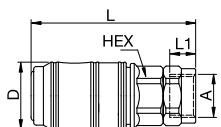
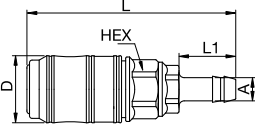
	Connection A	HEX mm	L mm	L1 mm	D mm	Color Sleeve	Part Number POM	Part Number CHEM	Part Number CHEM+
 <p>Male Thread</p>	G 1/4	21	70,5	9	26	Standard	48KBAW13DPX		
	G 3/8	21	67	9	26	Standard	48KBAW17DPX	48KBAW17FVX	48KBAW17FVP
	G 1/2	21	73,5	12	26	Standard	48KBAW21DPX	48KBAW21FVX	
 <p>Female Thread</p>	G 1/4	21	63,5	10	26	Standard	48KBIW13DPX	48KBIW13FVX	48KBIW13FVP
	G 3/8	21	63,5	13	26	Standard	48KBIW17DPX	48KBIW17FVX	48KBIW17FVP
	G 3/8	21	63,5	13	26	blue	48KBIW17DPXB	48KBIW17FVXB	
	G 3/8	21	63,5	13	26	green	48KBIW17DPXG	48KBIW17FVXG	
	G 3/8	21	63,5	13	26	red	48KBIW17DPXR	48KBIW17FVXR	
	G 3/8	21	63,5	13	26	yellow	48KBIW17DPXY	48KBIW17FVXY	
 <p>Hose Barb</p>	6 mm	21	81	22	26	Standard			48KBTf06FVP
	9 mm	21	81	22	26	Standard	48KBTf09DPX	48KBTf09FVX	48KBTf09FVP
	13 mm	21	84	25	26	Standard	48KBTf13DPX	48KBTf13FVX	



Plugs – without valve

Series 48SF

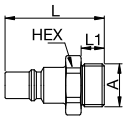
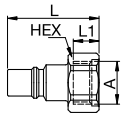
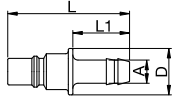
	Connection A	HEX mm	L mm	L1 mm	D mm	Color Sleeve	Part Number POM	Part Number CHEM	Part Number CHEM+
 <p>Male Thread</p>	G 1/4	17	38,5	9		Standard	48SFAW13DXX	48SFAW13FXX	
	G 3/8	21	38,5	9		Standard	48SFAW17DXX	48SFAW17FXX	
	G 1/2	21	41,5	12		Standard		48SFAW21FXX	
 <p>Female Thread</p>	G 1/4	17	35,5	9		Standard	48SFIW13DXX		
	G 3/8	21	35,5	10		Standard	48SFIW17DXX	48SFIW17FXX	
	G 3/8	21	35,5	10		blue	48SFIW17DXXB	48SFIW17FXXB	
	G 3/8	21	35,5	10		green	48SFIW17DXXG	48SFIW17FXXG	
	G 3/8	21	35,5	10		red	48SFIW17DXXR	48SFIW17FXXR	
	G 3/8	21	35,5	10		yellow	48SFIW17DXXY	48SFIW17FXXY	
	G 1/2	24	59	13		Standard	48SFIW21DXX		
 <p>Hose Barb</p>	6 mm		47	22	18	Standard		48SFTf06FXX	
	9 mm		47	22	18	Standard	48SFTf09DXX	48SFTf09FXX	
	13 mm		50	25	18	Standard	48SFTf13DXX	48SFTf13FXX	



Plugs – with valve

Series 48SB

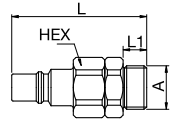
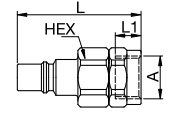
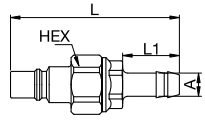
	Connection A	HEX mm	L mm	L1 mm	D mm	Color Sleeve	Part Number POM	Part Number CHEM	Part Number CHEM+
 <p>Male Thread</p>	G 1/4	21	55	9		Standard	48SBAW13DPX		48SBAW13FVP
	G 3/8	21	51,5	9		Standard	48SBAW17DPX	48SBAW17FVX	
 <p>Female Thread</p>	G 1/4	21	48	10		Standard	48SBIW13DPX		
	G 3/8	21	48	10		Standard	48SBIW17DPX		48SBIW17FVP
	G 3/8	21	48	10		blue	48SBIW17DPXB		
	G 3/8	21	48	10		green	48SBIW17DPXG		
	G 3/8	21	48	10		red	48SBIW17DPXR		
	G 3/8	21	48	10		yellow	48SBIW17DPXY		
	G 1/2	21	59	13		Standard		48SBIW21FVX	
	G 1/2	21	59	13		blue		48SBIW21FVXB	
	G 1/2	21	59	13		green		48SBIW21FVXG	
	G 1/2	21	59	13		red		48SBIW21FVXR	
	G 1/2	21	59	13		yellow		48SBIW21FVXY	
 <p>Hose Barb</p>	6 mm	21	65,5	22		Standard	48SBTF06DPX		
	9 mm	21	65,5	22		Standard	48SBTF09DPX	48SBTF09FVX	
	9 mm	21	65,5	22		blue		48SBTF09FVXB	
	9 mm	21	65,5	22		green		48SBTF09FVXG	
	9 mm	21	65,5	22		red		48SBTF09FVXR	
	9 mm	21	65,5	22		yellow		48SBTF09FVXY	
	13 mm	21	68,5	25		Standard	48SBTF13DPX	48SBTF13FVX	48SBTF13FVP



Coupling range in sizes from 1/8" to 1 1/2" with plug profile in accordance with ISO 7241-1 series B. Particularly suitable for use with liquid media.

Coupling system with two-hand operation, i.e. the locking sleeve must be pushed back manually when coupling. The coupling range stands out for its high flow rates against a low pressure drop. 1 1/2" design (series 77) with locking pin and EPDM seal.

Working Temperature*

-20°C up to +90°C (NBR)
-40°C up to +90°C (EPDM)
depending on the medium.

* For temperatures below -20°C and over +90°C and depending on the medium, other seal variants (FKM, FFKM) are available.

**Working Pressure****

see chart

** maximum static working pressure with design factor 4 to 1.

Material

Coupling: POM white

Plug: POM white

Seals: NBR

Interchangeability

• ISO 7241-1 Series B

Technical Description

See Rectus series 70 - brass/steel from page 126

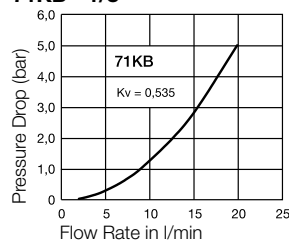
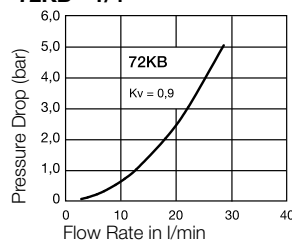
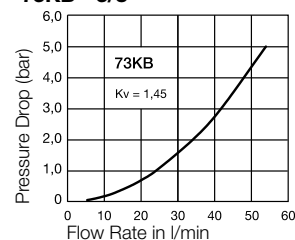
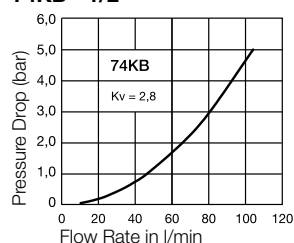
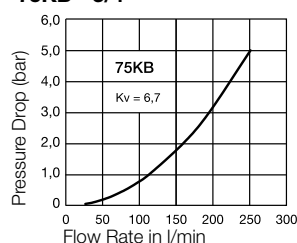
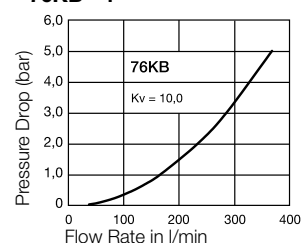
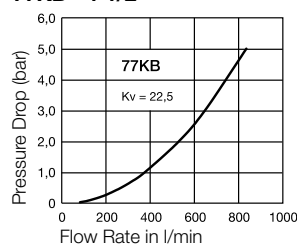
Flow diagrams Water**71KB - 1/8"****72KB - 1/4"****73KB - 3/8"****74KB - 1/2"****75KB - 3/4"****76KB - 1"****77KB - 1 1/2"****Other designs in series 70**

The following other designs can be found from page:

- Brass / Steel P. 126
- Stainless Steel P. 164



Couplings – with valve

Series 70KB

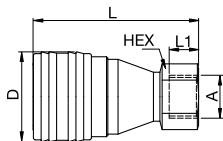

Female Thread

Size	Connection A	HEX mm	HEX1 mm	L mm	L1 mm	L2 mm	D mm	B mm	Working Pressure max. / bar	Part Number
1/4"	G 1/4	19		57,5	10		28,5		15	72KBIW13DPX
3/8"	G 3/8	22		64	11,5		35		15	73KBIW17DPX
1/2"	G 1/2	27		76	16		44,5		10	74KBIW21DPX
3/4"	G 3/4	34		96	24		55		10	75KBIW26DPX
1"	G 1	41		105,5	24		62		10	76KBIW33DPX
1 1/2"	G 1 1/2	60		133	23		76		10	77KBIW48DEXS



Plugs – with valve

Series 70KB

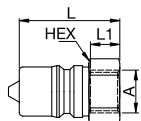

Female Thread

Size	Connection A	HEX mm	HEX1 mm	L mm	L1 mm	L2 mm	D mm	B mm	Working Pressure max. / bar	Part Number
1/4"	G 1/4	19		35	10				15	72SBIW13DPX
3/8"	G 3/8	22		39	11,5				15	73SBIW17DPX
1/2"	G 1/2	27		48	16				10	74SBIW21DPX
3/4"	G 3/4	36		60	24				10	75SBIW26DPX
1"	G 1	41		56	24				10	76SBIW33DPX
1 1/2"	G 1 1/2	60		132	23				10	77SBIW48DEX

Plastic fittings

Male x Male Nipple

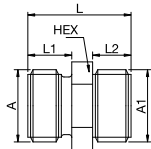

Connection A	Connection A1	HEX mm	HEX1 mm	L mm	L1 mm	L2 mm	L3 mm	B mm	G mm	POM design Part Number	CHEM design Part Number
G 1/4	G 1/8	14		19	8	7				DN13/10DX	DN13/10FX
G 1/4	G 1/4	14		19	8	7				DN13/13DX	DN13/13FX
G 3/8	G 1/4	17		28,5	9	9				DN17/13DX	DN17/13FX
G 3/8	G 3/8	21		25	9	9				DN17/17DX	DN17/17FX
G 3/8	G 1/2	21		31,5	9	12				DN17/21DX	DN17/21FX

Reducing Bush

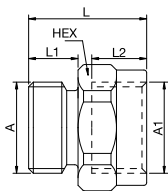

Connection A	Connection A1	HEX mm	HEX1 mm	L mm	L1 mm	L2 mm	L3 mm	B mm	G mm	POM design Part Number	CHEM design Part Number
G 1/4	G 1/8	14		22	8	8				RL13/10DX	
G 1/4	G 1/4	17		25	8	10				RL13/13DX	RL13/13FX
G 3/8	G 1/4	17		21,5	9	10				RL17/13DX	RL17/13FX
G 3/8	G 3/8	21		21,5	9	10				RL17/17DX	RL17/17FX
G 3/8	G 1/2	17		32,5	9	13				RL17/21DX	RL17/21FX

Hose Tail Barb

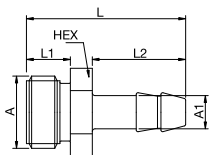

Connection A	Connection A1	HEX mm	HEX1 mm	L mm	L1 mm	L2 mm	L3 mm	B mm	G mm	POM design Part Number	CHEM design Part Number
G 1/4	4 mm	14		29	8	17				GT13/04DX	GT13/04FX
G 1/4	6 mm	14		29	8	17				GT13/06DX	GT13/06FX
G 3/8	6 mm	17		39	9	22				GT17/06DX	GT17/06FX
G 3/8	9 mm	17		39	9	22				GT17/09DX	GT17/09FX
G 3/8	10 mm	17		39	9	22				GT17/10DX	
G 3/8	13 mm	17		42	9	25				GT17/13DX	GT17/13FX

Plastic Screw Connector

Connection A	Connection A1	HEX mm	HEX1 mm	L mm	L1 mm	L2 mm	L3 mm	B mm	G mm	POM design Part Number	CHEM design Part Number
G 1/4	4 x 6 mm	14		25	8	13			M 10 x 1	EV13/06DX	EV13/06FX
G 1/4	6 x 8 mm	14		25	8	13			M 12 x 1	EV13/08DX	EV13/08FX

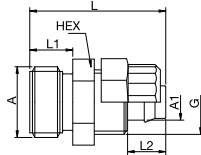

Panel Mount, Plastic Hose Connection

Connection A	Connection A1	HEX mm	HEX1 mm	L mm	L1 mm	L2 mm	L3 mm	B mm	G mm	POM design Part Number	CHEM design Part Number
G 1/4	4 x 6 mm	14	14	37	7	8	18	4	M 10 x 1	EK13/06DX	
G 1/4	6 x 8 mm	14	17	37	8	8	18	4	M 12 x 1	EK13/08DX	

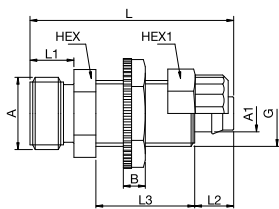



The NSI are dry-break couplings with flat face valves. The compact design make them suitable for reduced spaces. Coupling system with two-hand operation, i.e. both hands are required when connect/disconnect.

No spillage during connection/disconnection. Low pressure drop. Excellent resistance to vibrations and mechanical stresses.

Working Temperature*

-20°C up to +200°C (FKM)
depending on the medium.

* For temperatures below -20°C and over +200°C and depending on the medium, other seal variants (NBR, EPDM, FFKM) are available.

**Working Pressure**

60 bar

Material

Coupling: Brass/Stainless Steel

Plug: Brass/Stainless Steel

Seals: FKM

Technical Description

Dead space volume DN 3: 0 ml

Dead space volume DN 6: 0,01 ml

Dead space volume DN 9: 0,04 ml

Dead space volume DN 12: 0,1 ml

Connecting Force 0 bar DN 3: 25 N

Connecting Force 0 bar DN 6: 100 N

Connecting Force 0 bar DN 9: 85 N

Connecting Force 0 bar DN 12: 190 N

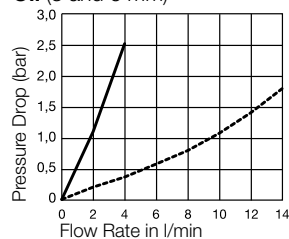
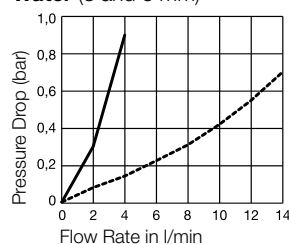
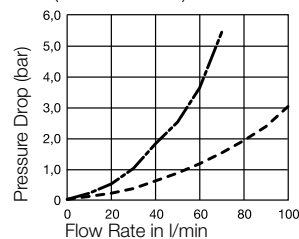
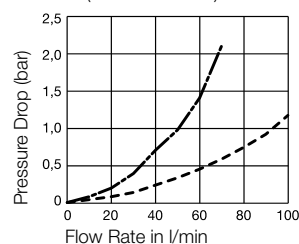

Flow diagrams**Oil (3 and 6 mm)****Water (3 and 6 mm)****Oil (9 and 12 mm)****Water (9 and 12 mm)**

— DN 3 mm
- - - DN 6 mm
— DN 9 mm
- - - DN 12 mm

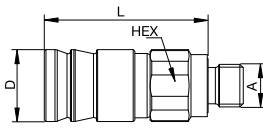

Couplings – flat sealing

Series NSI

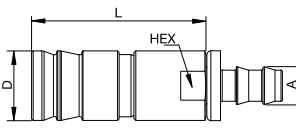
	DN	Connection A	HEX mm	L mm	D mm	Part Number
 <p>Male Thread</p>	3	G 1/8	14	38	17	NSI-121-2MBE ¹
	6	M 16 x 1,5	20	44,8	22	NSI-251-16MCL-2 ²
	9	G 3/8	27	63	30	NSI-371-6MBO
	12	G 1/2	35	90,4	42	NSI-501-8MBO
 <p>Female Thread</p>	6	G 1/4	20	57,9	22	NSI-251-4FB
	9	G 3/8	27	72	30	NSI-371-6FB
	12	G 1/2	35	99,4	42	NSI-501-8FB
 <p>Parker Push-Lok</p>	6	10 mm	20	55,2	22	NSI-251-6PL



Plugs – flat sealing

Series NSI

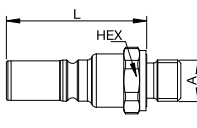
	DN	Connection A	HEX mm	L mm	D mm	Part Number
 <p>Male Thread</p>	3	G 1/8	14	36,5		NSI-122-2MBE ¹
	6	G 1/4	19	44		NSI-252-4MBE ¹
	9	G 3/8	24	60,2		NSI-372-6MBO
	12	G 1/2	32	79,1		NSI-502-8MBO

¹ End connection according to ISO1179-2 ED seal

² End connection according to DIN 2353 24°cone



Dry-break cartridge couplings without locking mechanism made of stainless steel. Available in six different sizes for modular block/plate assembly in sensitive environments. Different coupling sizes can be combined to one multicoupling depending on the application requirements.

No spillage and minimum dead space volume. No air inclusion when connecting. Tolerates deviations in axial alignment when installing.

Working Temperature*

-15°C up to +200°C (FKM)
depending on the medium.

* For temperatures below -15°C and over +200°C and depending on the medium, other seal variants (NBR, EPDM, FFKM) are available.

**Working Pressure****

15 bar

** maximum static working pressure with design factor 4 to 1.

Material

Coupling: AISI 316 L
Plug: AISI 316 L
Seals: FKM

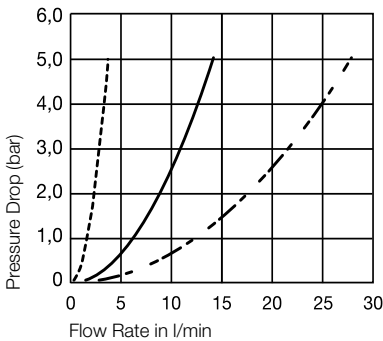
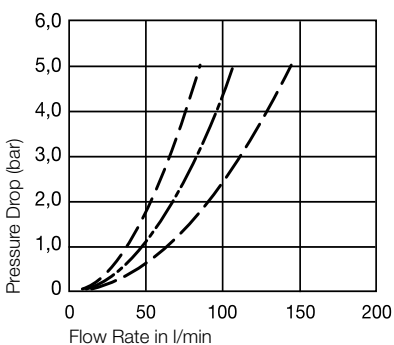
Flow diagrams**Water (3, 4 and 6 mm)****Water (9, 12 and 19 mm)**

----- 3 mm - - - - - 9 mm
————— 4 mm - - - - - 12 mm
- - - - - 6 mm - - - - - 19 mm

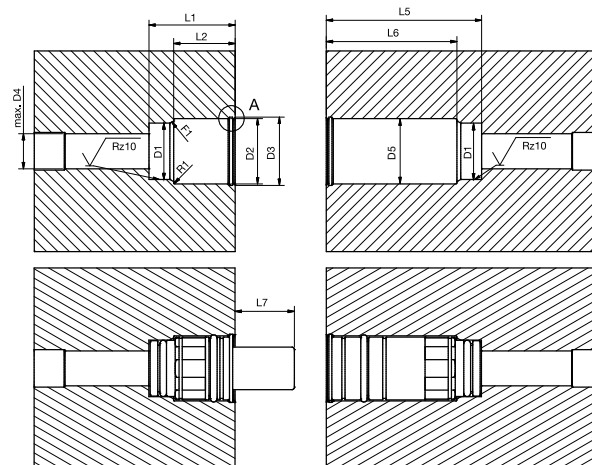
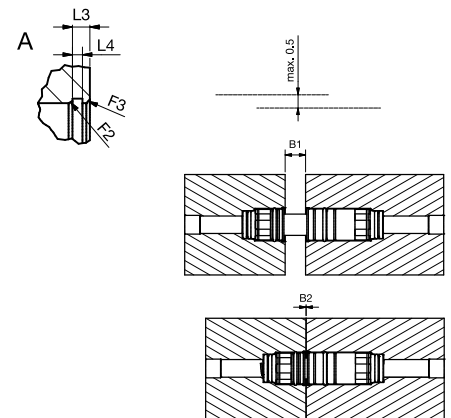
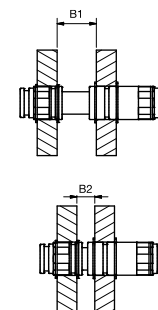
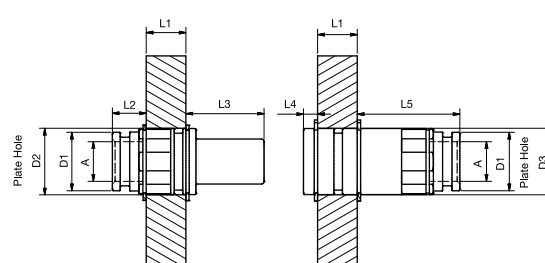
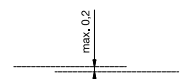
Technical Features for block- and plate assembly – Tolerances for production of the holder on request.**Block Assembly****Misalignment for block assembly****Plate Assembly****Misalignment for plate assembly**



Couplings – flat sealing

Series 200KLEK

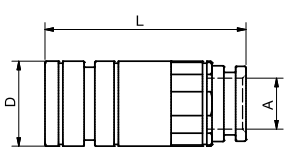
	Nominal Diameter mm	Connection A	L mm	L1 mm	D mm	D1 mm	Part Number
 <p>Female Thread</p>	3	G 1/16	21,50		11,00		203KLIW08EVXEK
	4	G 1/8	35,70		16,00		204KLIW10EVXEK
	6	G 1/4	53,70		21,00		206KLIW13EVXEK
	9	G 3/8	59,10		25,00		209KLIW17EVXEK
	12	G 1/2	70,90		32,00		212KLIW21EVXEK
	19	G 3/4	77,00		44,00		219KLIW26EVXEK



Plugs – flat sealing

Series 200KLEK

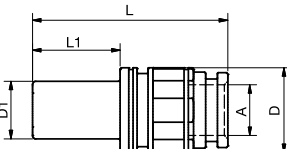
	Nominal Diameter mm	Connection A	L mm	L1 mm	D mm	D1 mm	Part Number
 <p>Female Thread</p>	3	G 1/16	28,70	10,75	11,00	5,30	203SLIW08EVXEK
	4	G 1/8	41,90	15,00	16,00	8,40	204SLIW10EVXEK
	6	G 1/4	51,15	19,00	21,00	12,50	206SLIW13EVXEK
	9	G 3/8	57,40	25,80	25,00	17,00	209SLIW17EVXEK
	12	G 1/2	69,70	28,00	30,00	20,00	212SLIW21EVXEK
	19	G 3/4	82,40	32,45	41,00	30,00	219SLIW26EVXEK

Block Assembly

ND mm	L1 mm	L2 mm	L3 mm	L4 mm	L5 mm	L6 mm	L7 mm	D1 mm	D2 mm	D3 mm	D4 max. mm	D5 mm	R1 max. mm	F1	F2	F3	B1	B2
3	20,10	15,00	2,10	1,10	23,60	18,50	8,75	10,00	12,00	12,50	8,00	12,00	0,50	0,8x30°	–	0,5x45°	5,00	0
4	29,00	22,50	2,10	1,10	37,80	31,35	13,00	14,00	17,00	17,80	10,00	17,00	0,50	1,2x30°	0,5x30°	0,5x45°	8,65	0
6	34,25	26,65	2,10	1,10	55,80	48,20	17,00	18,50	22,00	23,00	12,00	22,00	0,50	1,3x30°	0,5x30°	0,5x45°	11,40	0
9	33,80	24,30	2,30	1,30	61,30	51,80	23,60	22,50	26,00	27,20	14,00	26,00	0,50	1,5x30°	0,5x30°	0,5x45°	16,30	0
12	44,00	34,40	2,30	1,30	73,20	63,60	25,80	28,00	31,00	32,70	16,00	33,00	0,50	1,5x30°	0,8x30°	0,5x45°	15,80	0
19	53,15	41,50	3,15	1,85	80,20	68,50	29,25	33,00	42,00	44,50	23,00	45,00	1,50	1,5x30°	1,0x30°	0,8x45°	20,30	0

Plate Assembly

ND mm	L1 mm	L2 mm	L3 mm	L4 mm	L5 mm	L6 mm	L7 mm	D1 mm	D2 mm	D3 mm	Connecton A	F1	F2	F3	B1	B2
3	5,00	11,00	12,75	5,50	11,00			9,80	11,2	11,2	G 1/16				16,70	11,70
4	15,00	9,80	17,20	5,50	15,35			13,80	16,2	16,2	G 1/8				20,50	12,70
6	15,00	13,15	23,00	5,50	33,20			18,30	21,2	21,2	G 1/4				25,00	13,50
9	15,00	12,80	29,60	5,30	38,80			22,30	25,2	25,2	G 3/8				29,80	13,50
12	15,00	22,90	31,80	5,30	50,60			27,80	30,2	32,2	G 1/2				29,40	12,30
19	15,00	32,00	35,40	4,40	57,60			32,80	41,2	44,2	G 3/4				33,85	12,30

⚠ Please consider our security advices on the pages 12/13 ⚠



Dry-break coupling system for applications in sensitive environments, for example in analysis technology, in cooling systems, in transport systems and many applications with aggressive media.

Coupling system with single-hand operation, extremely low leakage rates and minimal dead space volume. Absolutely no air pockets when coupling and only a barely noticeable film of the medium being channelled on the valve bodies when uncoupling. Ergonomic sleeve design. Low coupling forces. Valve body protected by collar design.

Working Temperature*

-20°C up to +100°C (NBR)
-15°C bis +200°C (FKM)
depending on the medium.

* For temperatures below -20°C and over +200°C and depending on the medium, other seal variants (EPDM, FFKM) are available.

**Working Pressure****

15 bar

** maximum static working pressure with design factor 4 to 1.

Material

Coupling: Brass nickel plated or Stainless Steel

Plug: Brass nickel plated or Stainless Steel

Seals: NBR or FKM

Technical Description**Series 204KL**

Dead space volume: 0,015 ml

Connecting Force 0 bar: 70 N
Connecting Force 6 bar: 100 N

Vacuum Coupling: 95%
Vacuum Plug: 95%
Vacuum connected: 95%

Series 206KL

Dead space volume: 0,035 ml

Connecting Force 0 bar: 80 N
Connecting Force 6 bar: 150 N

Vacuum Coupling: 95%
Vacuum Plug: 95%
Vacuum connected: 95%

Series 209KL

Dead space volume: 0,072 ml

Connecting Force 0 bar: 130 N
Connecting Force 6 bar: 270 N

Vacuum Coupling: 95%
Vacuum Plug: 95%
Vacuum connected: 95%

Interchangeability

- Rectus Design

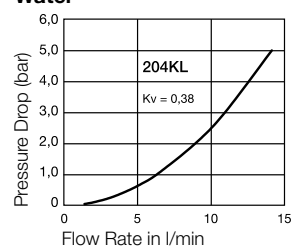
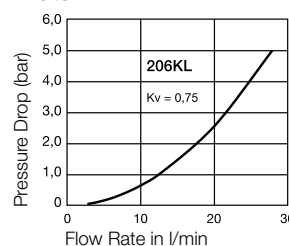
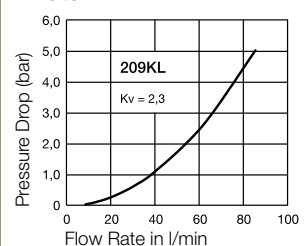
Flow diagrams**Water****Water****Water**



Couplings – flat sealing

Series 200KL

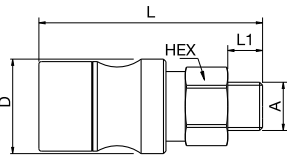
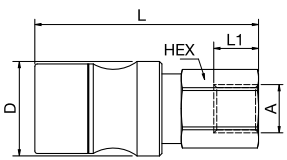
	NW	Connection A	HEX mm	L mm	L1 mm	D mm	Version	Part Number
 <p>Male Thread</p>	4	G 1/8	14	45	7	19	Brass	204KLAW10MPN
	4	G 1/8	14	45	7	19	AISI 316 L	204KLAW10EVX
	4	G 1/4	17	47	9	19	Brass	204KLAW13MPN
	4	G 1/4	17	47	9	19	AISI 316 L	204KLAW13EVX
	6	G 3/8	22	68,5	9	25,5	Brass	206KLAW17MPN
	6	G 3/8	22	68,5	9	25,5	AISI 316 L	206KLAW17EVX
	6	G 1/2	22	71,5	12	25,5	Brass	206KLAW21MPN
	6	G 1/2	24	71,5	12	25,5	AISI 316 L	206KLAW21EVX
 <p>Female Thread</p>	4	G 1/8	14	45	9	19	Brass	204KLIW10MPN
	4	G 1/8	14	45	9	19	AISI 316 L	204KLIW10EVX
	4	G 1/4	17	47	9	19	Brass	204KLIW13MPN
	4	G 1/4	17	47	9	19	AISI 316 L	204KLIW13EVX
	6	G 3/8	22	68,5	7	25,5	Brass	206KLIW17MPN
	6	G 3/8	22	68,5	9	25,5	AISI 316 L	206KLIW17EVX
	6	G 1/2	24	71,5	10	25,5	Brass	206KLIW21MPN
	6	G 1/2	24	71,5	12	25,5	AISI 316 L	206KLIW21EVX
	9	G 1/2	27	92	14	33	Brass	209KLIW21MPN
	9	G 1/2	27	92	16	33	AISI 316 L	209KLIW21EVX
	9	G 3/4	32	94	14	33	Brass	209KLIW26MPN
	9	G 3/4	32	94	16	33	AISI 316 L	209KLIW26EVX



Plugs – flat sealing

Series 200KL

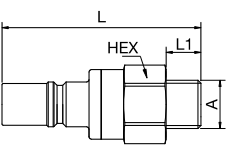
	NW	Connection A	HEX mm	L mm	L1 mm	D mm	Version	Part Number
 <p>Male Thread</p>	4	G 1/8	14	40	7		Brass	204SLAW10MPN
	4	G 1/8	14	40	7		AISI 316 L	204SLAW10EVX
	4	G 1/4	17	42	9		Brass	204SLAW13MPN
	4	G 1/4	17	42	9		AISI 316 L	204SLAW13EVX
	6	G 3/8	22	51	9		Brass	206SLAW17MPN
	6	G 3/8	22	55	9		AISI 316 L	206SLAW17EVX
	6	G 1/2	22	54	12		Brass	206SLAW21MPN
	6	G 1/2	24	54	12		AISI 316 L	206SLAW21EVX



Plugs – flat sealing

Series 200KL

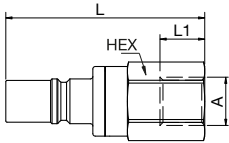
	NW	Connection A	HEX mm	L mm	L1 mm	D mm	Version	Part Number
 <p>Female Thread</p>	4	G 1/8	14	40	9		Brass	204SLIW10MPN
	4	G 1/8	14	40	9		AISI 316 L	204SLIW10EVX
	4	G 1/4	17	42	7		Brass	204SLIW13MPN
	4	G 1/4	17	42	9		AISI 316 L	204SLIW13EVX
	6	G 3/8	22	51	7		Brass	206SLIW17MPN
	6	G 3/8	22	51	9		AISI 316 L	206SLIW17EVX
	6	G 1/2	24	54	10		Brass	206SLIW21MPN
	6	G 1/2	24	54	12		AISI 316 L	206SLIW21EVX
	9	G 1/2	27	79,5	14		Brass	209SLIW21MPN
	9	G 1/2	27	79,5	16		AISI 316 L	209SLIW21EVX
	9	G 3/4	32	81,5	14		Brass	209SLIW26MPN
	9	G 3/4	32	81,5	16		AISI 316 L	209SLIW26EVX



The RNS are rigid couplings with flat face valves. They can be mounted on rigid manifolds or tubing and assure connection/disconnection without spillage. Base material is brass and stainless steel.

Push-Pull connection/disconnection, break-away function. Dry-break connection/disconnection. Connection guiding system and compensation of misalignment during connection on rack systems (when both are mounted on rigid devices). Specific design for cooling applications.

Working Temperature*

-30°C up to +100°C (NBR)
depending on the medium.

* For temperatures below -30°C and over +100°C and depending on the medium, other seal variants (FKM, EPDM, FFKM) are available.



Working Pressure**

60 bar

** maximum static working pressure with safety factor 4 to 1.

Material

Coupling: Brass/Stainless Steel

Plug: Brass/Stainless Steel

Seals: NBR

Technical Description

Dead space volume: 0,1 ml

Connecting Force 0 bar: 95 N

Flow diagrams

Oil

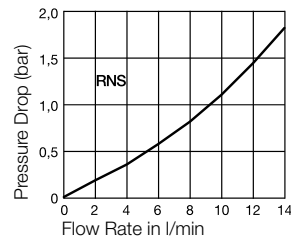

Water

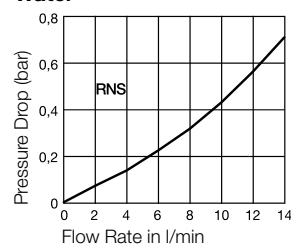



Couplings – flat sealing

Series RNS

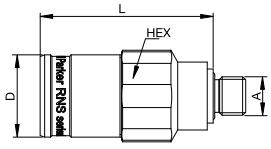
	DN	Connection A	HEX mm	L mm	D mm	Part Number
 <p>Male Thread</p>	6	G 1/4	30	58,6	28	RNS-251-4MBO



Plugs – flat sealing

Series RNS

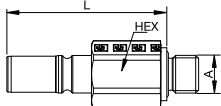
	DN	Connection A	HEX mm	L mm	D mm	Part Number
 <p>Male Thread</p>	6	G 1/4	21	55,2		RNS-252-4MBO



The NSP are dry-break couplings with flat face valves. The compact design make them suitable for reduced spaces. Coupling system with single-hand operation.

No spillage during connection/disconnection. Push to connect function. Low pressure drop. Specific design for cooling applications. Can be used either with water and heat transfer oils. Excellent resistance to vibrations and mechanical stresses.

Working Temperature*

-20°C up to +200°C (FKM)
depending on the medium.

* For temperatures below -20°C and over +200°C and depending on the medium, other seal variants (NBR, EPDM, FFKM) are available.

**Working Pressure****

60 bar

** maximum static working pressure with safety factor 4 to 1.

Material

Coupling: Brass/Stainless Steel

Plug: Brass/Stainless Steel

Seals: FKM

Technical Description

Dead space volume DN 6: 0,01 ml

Dead space volume DN 9: 0,04 ml

Dead space volume DN 12: 0,1 ml

Connecting Force 0 bar DN 6: 110 N

Connecting Force 0 bar DN 9: 95 N

Connecting Force 0 bar DN 12: 195 N

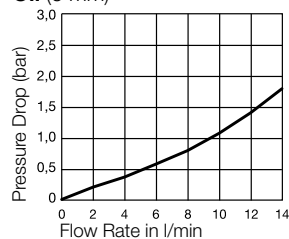
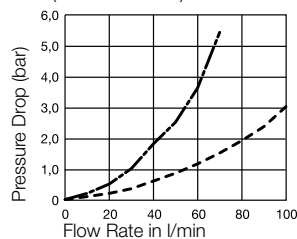
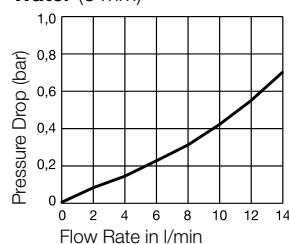
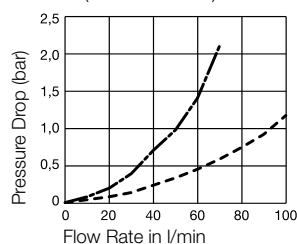
Flow diagrams**Oil (6 mm)****Oil (9 and 12 mm)****Water (6 mm)****Water (9 and 12 mm)**

— DN 6 mm
 - - - DN 9 mm
 - - - DN 12 mm



Couplings – flat sealing

Series NSP

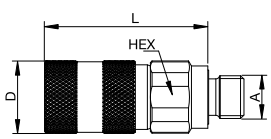
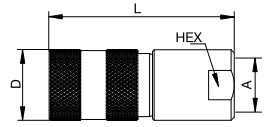
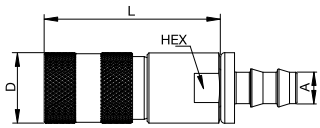
	DN	Connection A	HEX mm	L mm	D mm	Part Number
 <p>Male Thread</p>	6	G 1/4	21	51,7	22	NSP-251-4MBE ¹
	6	M 16 x 1,5	20	44,8	22	NSP-251-16MCL ²
	9	G 3/8	27	63	30	NSP-371-6MBO
	12	G 1/2	35	90,4	42	NSP-501-8MBO
 <p>Female Thread</p>	6	G 1/4	20	57,9	22	NSP-251-4FB
	9	G 3/8	27	72	30	NSP-371-6FB
	12	G 1/2	35	99,4	42	NSP-501-8FB
 <p>Hose Barb</p>	6	10 mm	20	55,2	22	NSP-251-6PL



Plugs – flat sealing

Series NSI

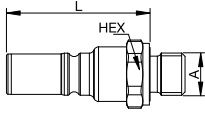
	DN	Connection A	HEX mm	L mm	D mm	Part Number
 <p>Male Thread</p>	6	G 1/4	19	44		NSI-252-4MBE ¹
	9	G 3/8	24	60,2		NSI-372-6MBO
	12	G 1/2	32	79,1		NSI-502-8MBO

¹ End connection according to ISO1179-2 ED seal

² End connection according to DIN 2353 24°cone



Minimal fluid loss during disconnection. NSA couplings have minimal pressure drop and no inclusion of air or dust during connection.

Dry-break poppet valve for reduced spillage during connection/disconnection. Light weight due to aluminium construction. Push-Lok connection for fast assembly - time saving.

Working Temperature*

-50°C up to +175°C (Fluorosilicone) depending on the medium.

* For temperatures below -50°C and over +175°C and depending on the medium, other seal variants (NBR, FKM, EPDM, FFKM) are available.

**Working Pressure**

20 bar

Material

Coupling: Anodized Aluminium

Plug: Anodized Aluminium

Seals: Fluorosilicone

Technical Description

Dead space volume DN 10: 0,08 ml

Dead space volume DN 12: 0,1 ml

Connecting Force 0 bar DN 10: 100 N

Connecting Force 0 bar DN 12: 167 N

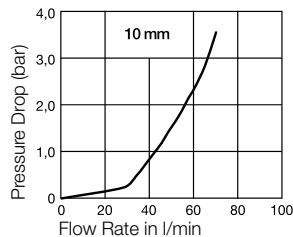
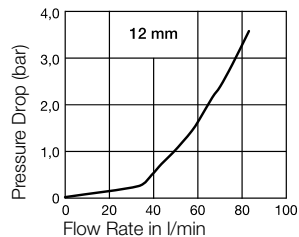
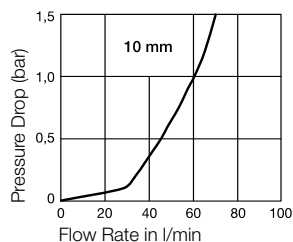
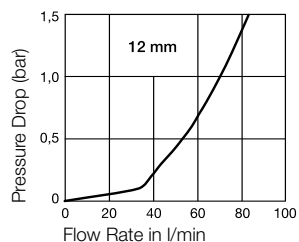
Flow diagrams**Oil****Oil****Water****Water**



Couplings – flat sealing

Series NSA

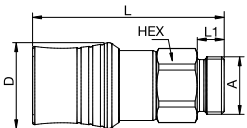
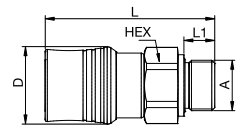
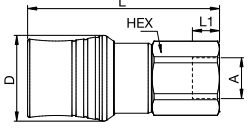
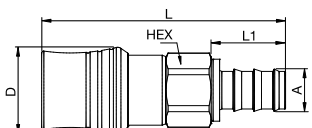
	DN	Connection A	HEX mm	L mm	L1 mm	D mm	Part Number
 <p>Male Thread metric DIN 2353</p>	12	M 30 x 1,5	35	99,4	14	44,5	NSA-501-30MCL
 <p>Male Thread BSPP</p>	10	G 3/4	35	88	16	40	NSA-391-12MBO
 <p>Female Thread BSPP</p>	12	G 1/2	35	99,4	14	44,5	NSA-501-8FB
 <p>Parker Push-Lok</p>	12	19 mm	35	126,40	38,30	44,5	NSA-501-12PL



Plugs – flat sealing

Series NSA

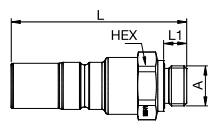
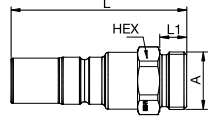
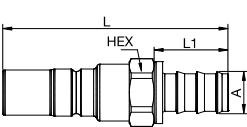
	DN	Connection A	HEX mm	L mm	L1 mm	D mm	Part Number	
 <p>Male Thread BSPP with O-ring Seal</p>	10	G 1/2	27	81	14		NSA-392-8MBO	
	12	G 1/2	32	91,1	12		NSA-502-8MBO	
 <p>Male Thread BSPP</p>	12	M 30 x 1,5	32	91,1	14		NSA-502-30MCL	
 <p>Parker Push-Lok</p>	12	19 mm	32	117,1	38,3		NSA-502-12PL	



The NSE are dry-break couplings with flat face valves. The compact design makes it suitable for reduced spaces when high flow is needed. Coupling system with two-hand operation, i.e. both hands are required when connect/disconnect.

High flow with low pressure drop. No spillage during connection/disconnection. Specific design for cooling applications. Reduced dimensions compared to flow capacities.

Working Temperature*

-20°C up to +200°C (FKM)
depending on the medium.

* For temperatures below -20°C and over +200°C and depending on the medium, other seal variants (NBR, EPDM, FFKM) are available.



Working Pressure**

15 bar

** maximum static working pressure with safety factor 4 to 1.

Material

Coupling: Stainless Steel

Plug: Stainless Steel

Seals: FKM

Technical Description

Dead space volume DN 16: 0,12 ml

Dead space volume DN 19: 0,15 ml

Dead space volume DN 25: 0,18 ml

Connecting Force 0 bar DN 16: 137 N

Connecting Force 0 bar DN 19: 160 N

Connecting Force 0 bar DN 25: 175 N

Flow diagrams

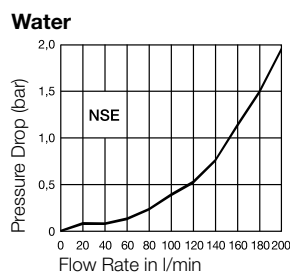
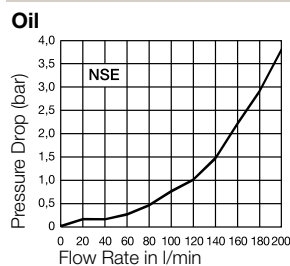



Couplings – flat sealing

Series NSE

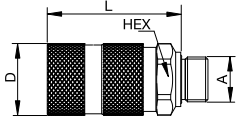
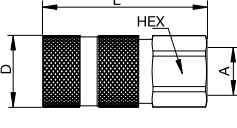
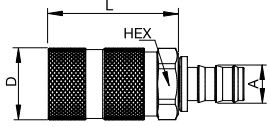
	DN	Connection A	HEX mm	L mm	D mm	Part Number
 Male Thread	16	G 3/4	34	68,8	37	NSE-621-12MBO
	19	G 3/4	38	78,5	42	NSE-751-12MBO
 Female Thread	19	G 1	38	96,6	42	NSE-751-16FB
	25	G 1 1/4	50	120,5	53	NSE-1001-20FB
 Parker Push-Lok	19	12,5 mm	38	76,4	42	NSE-751-8PL
	19	19 mm	38	76,4	42	NSE-751-12PL



Plugs – flat sealing

Series NSE

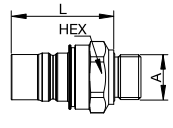
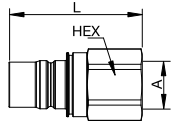
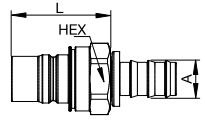
	DN	Connection A	HEX mm	L mm	D mm	Part Number
 Male Thread	16	G 3/4	34	56,5		NSE-622-12MBO
	19	G 3/4	38	60,3		NSE-752-12MBO
 Female Thread	19	G 1	38	78,4		NSE-752-16FB
	25	G 1 1/4	50	96,8		NSE-1002-20FB
 Parker Push-Lok	19	12,5 mm	38	58,2		NSE-752-8PL
	19	19 mm	38	58,2		NSE-752-12PL



Mini industrial coupling with the world's most popular profile in this nominal diameter. Above average flow performance for liquid and gaseous media. It also uses an additional safety locking system. This prevents unintentional disconnection. When being disconnected, the plug must first be pushed further into the coupling before it can be disconnected.

Series 21 in brass material without nickel plating and with additional end connections available on request.

Dust Protections  (P. 250)
for Coupling Part.-No. SK16S

Working Temperature*
-20°C up to +100°C (NBR)
depending on the medium.

* For temperatures below -20°C and over +100°C and depending on the medium, other seal variants (FKM, EPDM, FFKM) are available.

Other designs in series 21
The following other designs can be found from page:

- ▶ Brass / Steel P. 26
- ▶ Stainless Steel P. 140
- ▶ Thermoplastic P. 176
- ▶ Coded Systems P. 234



Working Pressure**

35 bar
** maximum static working pressure with design factor 4 to 1.

35 bar

Material

Coupling: Brass nickel plated
Plug: Brass nickel plated
Seals: NBR

Coupling: Brass nickel plated
Plug: Brass nickel plated
Seals: NBR

Technical Description

Connecting Force 0 bar: 35 N
Connecting Force 6 bar: 60 N

Dead space volume: 0,6 ml

Vacuum Coupling: 87%
Vacuum connected: 87%

Connecting Force 0 bar: 40 N
Connecting Force 6 bar: 80 N

Vacuum Coupling: 96%
Vacuum Plug: 96%
Vacuum connected: 96%

Flow diagrams

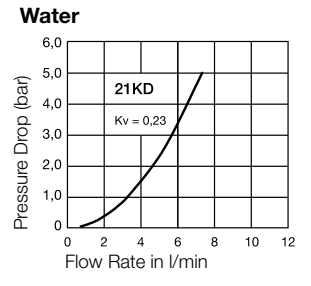
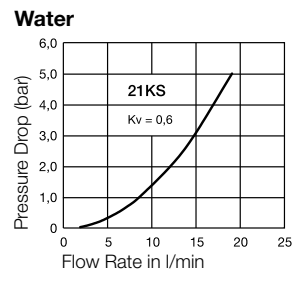
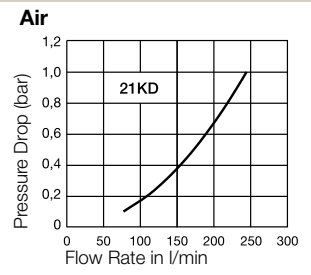
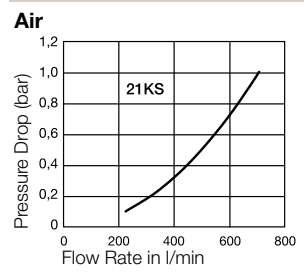



Couplings – with valve

Series 21KS

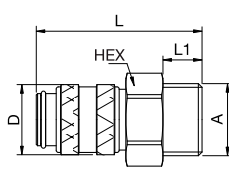
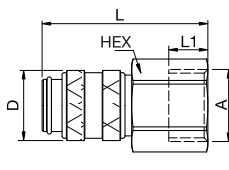
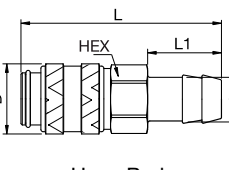
	Connection A	HEX mm	L mm	L1 mm	D mm	Part Number
 <p>Male Thread</p>	G 1/8	14	36	7	16	21KSAW10MPN
	G 1/4	17	38	9	16	21KSAW13MPN
	G 3/8	19	38	9	16	21KSAW17MPN
 <p>Female Thread</p>	G 1/8	14	36	9	16	21KSIW10MPN
	G 1/4	17	38	9	16	21KSIW13MPN
	G 3/8	19	38	6	16	21KSIW17MPN
 <p>Hose Barb</p>	4 mm	14	46	17	16	21KSTF04MPN
	5 mm	14	46	17	16	21KSTF05MPN
	6 mm	14	46	17	16	21KSTF06MPN
	8 mm	14	46	17	16	21KSTF08MPN
	9 mm	14	46	17	16	21KSTF09MPN
	10 mm	14	46	17	16	21KSTF10MPN



Plugs – without valve

Series 21KS

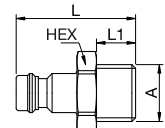
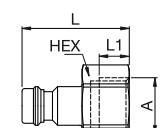
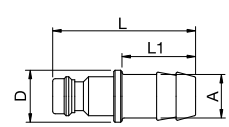
	Connection A	HEX mm	L mm	L1 mm	D mm	Part Number
 <p>Male Thread</p>	G 1/8	14	25	7		21SSAW10MXN
	G 1/4	17	28	9		21SSAW13MXN
 <p>Female Thread</p>	G 1/8	14	25	8		21SSIW10MXN
	G 1/4	17	25	9		21SSIW13MXN
 <p>Hose Barb</p>	6 mm		32	17	9	21SSTF06MXN
	8 mm		32	17	9	21SSTF08MXN
	10 mm		33	17	12	21SSTF10MXN

Couplings – with valve **Series 21KD**

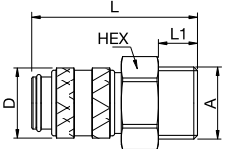
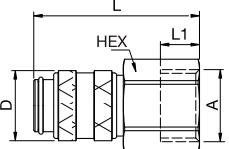
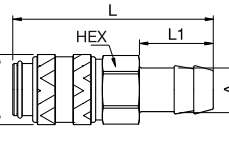
	Connection A	HEX mm	L mm	L1 mm	D mm	Part Number	
 <p>Male Thread</p>	G 1/8	14	36	7	16	21KDAW10MPN	
	G 1/4	17	38	9	16	21KDAW13MPN	
	G 3/8	19	38	9	16	21KDAW17MPN	
 <p>Female Thread</p>	G 1/8	14	36	9	16	21KDIW10MPN	
	G 1/4	17	38	9	16	21KDIW13MPN	
	G 3/8	19	38	9	16	21KDIW17MPN	
 <p>Hose Barb</p>	6 mm	14	46	17	16	21KDTF06MPN	
	10 mm	14	46	17	16	21KDTF10MPN	

Plugs – with valve **Series 21KD**

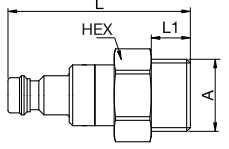
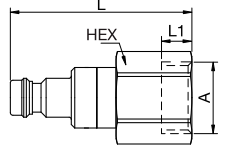
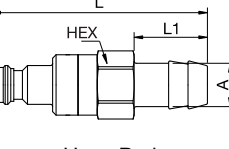
	Connection A	HEX mm	L mm	L1 mm	D mm	Part Number	
 <p>Male Thread</p>	G 1/8	14	40	7		21SDAW10MPN	
	G 1/4	17	42	9		21SDAW13MPN	
	G 3/8	19	42	9		21SDAW17MPN	
 <p>Female Thread</p>	G 1/8	14	40	7		21SDIW10MPN	
	G 1/4	17	42	7		21SDIW13MPN	
 <p>Hose Barb</p>	6 mm	14	50	17		21SDTF06MPN	
	10 mm	14	50	17		21SDTF10MPN	



Safety coupling with UltraFlo-Valve for optimum flow and low pressure drop. The series stands out for its robust design (steel sleeve) and long service life even with the harshest use. Additional safety locking system. This safety lock prevents unintentional disconnection. To disconnect, the plug must first be pushed further into the coupling before it can be unlocked. The brass version has been developed specifically for use with water in the pressure range up to 35 bar.

Working Temperature*
-20°C up to +100°C (NBR) depending on the medium.

* For temperatures below -20°C and over +100°C and depending on the medium, other seal variants (FKM, EPDM, FFKM) are available.

Series 25 in brass material with and without nickel plating and with additional end connections available on request.

Other designs in series 25

The following other designs can be found from page:

- Brass / Steel P. 70
- Stainless Steel P. 150
- Safety Self-Venting P. 230
- Coded Systems P. 236



Working Pressure**

35 bar (Brass-Version)
70 bar (with steel body and steel sleeve)
** maximum static working pressure with design factor 4 to 1.

35 bar

Features

- Double profiled plug design against wear of material during operation

- Handy sleeve for optimum operation even with gloves

Material

Coupling: Brass / Steel or Brass
Plug: Steel zinc plated or Brass
Seals: NBR

Coupling: Brass nickel plated
Plug: Brass nickel plated
Seals: NBR

Technical Description

Connecting Force 0 bar: 40 N
Connecting Force 6 bar: 120 N

Dead space volume: 1,5 ml

Vacuum Coupling: 87%
Available on request with O-ring seal for vacuum when coupled.

Connecting Force 0 bar: 40 N
Connecting Force 6 bar: 120 N

Vacuum Coupling: 96%
Vacuum Plug: 96%
Vacuum connected: 96%

Flow diagrams

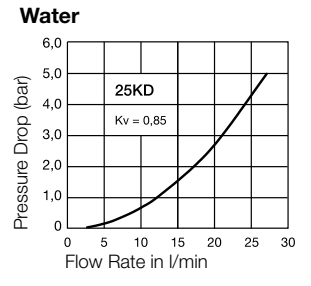
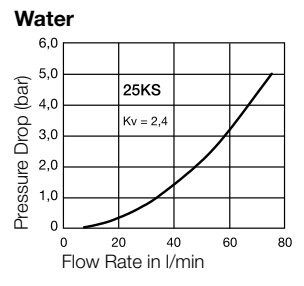
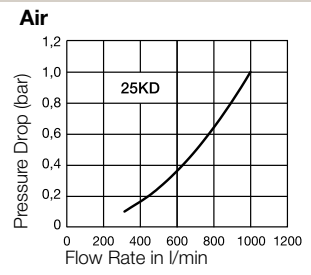
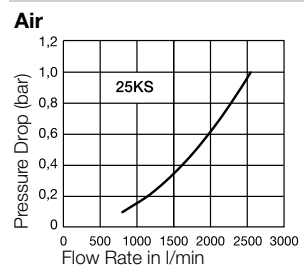



Couplings – with valve

Series 25KS

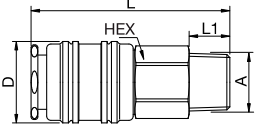
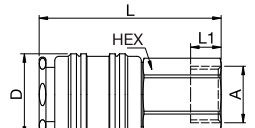
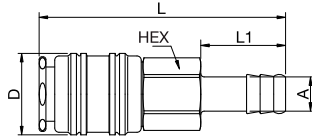
	Connection A	HEX mm	L mm	L1 mm	D mm	Part Number
 <p>Male Thread</p>	R 1/4	19	60	12	23	25KSAK13SPN
	R 3/8	19	60	12	23	25KSAK17SPN
	R 1/2	22	61	17	23	25KSAK21SPN
 <p>Female Thread</p>	G 1/4	19	56	10	23	25KSIW13SPN
	G 3/8	19	55	9	23	25KSIW17SPN
	G 1/2	24	58	12	23	25KSIW21SPN
 <p>Hose Barb</p>	6 mm	19	74	25	23	25KSTF06SPN
	8 mm	19	74	25	23	25KSTF08SPN
	9 mm	19	74	25	23	25KSTF09SPN
	10 mm	19	74	25	23	25KSTF10SPN
	13 mm	19	74	25	23	25KSTF13SPN



Plugs – without valve

Series 25KS

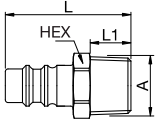
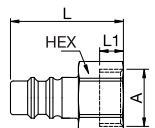
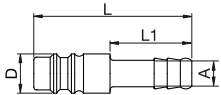
	Connection A	HEX mm	L mm	L1 mm	D mm	Part Number
 <p>Male Thread</p>	R 1/8	13	33	9		25SSAK10SXZ
	R 1/4	14	37	12		25SSAK13SXZ
	R 3/8	17	37	12		25SSAK17SXZ
	R 1/2	22	43	17		25SSAK21SXZ
 <p>Female Thread</p>	G 1/4	17	33	9		25SSIW13SXZ
	G 3/8	19	33	9		25SSIW17SXZ
 <p>Hose Barb</p>	9 mm		48	25	12	25SSTF09SXZ
	10 mm		48	25	12	25SSTF10SXZ

Couplings – with valve **Series 25KD**

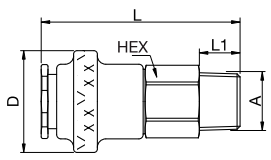
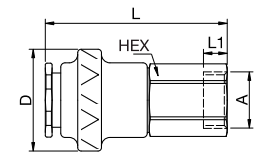
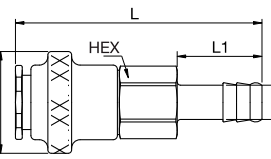
	Connection A	HEX mm	L mm	L1 mm	D mm	Part Number
 <p>Male Thread</p>	R 1/4	19	60	12	30	25KDAK13BPN
	R 3/8	19	60	12	30	25KDAK17BPN
	R 1/2	22	61	17	30	25KDAK21BPN
 <p>Female Thread</p>	G 1/4	19	56	10	30	25KDIW13BPN
	G 3/8	19	55	9	30	25KDIW17BPN
	G 1/2	24	58	12	30	25KDIW21BPN
 <p>Hose Barb</p>	6 mm	19	74	25	30	25KDTF06BPN
	8 mm	19	74	25	30	25KDTF08BPN
	10 mm	19	74	25	30	25KDTF10BPN
	13 mm	19	74	25	30	25KDTF13BPN

Plugs – with valve **Series 25KD**

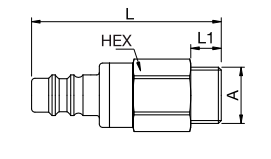
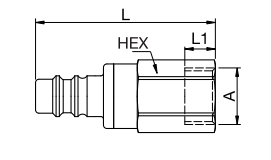
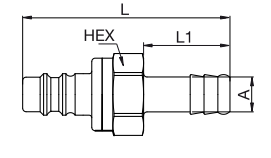
	Connection A	HEX mm	L mm	L1 mm	D mm	Part Number
 <p>Male Thread</p>	G 1/4	22	43	9		25SDAW13MPN
	G 3/8	22	43	9		25SDAW17MPN
	G 1/2	22	46	12		25SDAW21MPN
 <p>Female Thread</p>	G 1/4	22	43	10		25SDIW13MPN
	G 3/8	22	43	9		25SDIW17MPN
	G 1/2	24	46	12		25SDIW21MPN
 <p>Hose Barb</p>	6 mm	21	60	25		25SDTF06MPN
	8 mm	21	60	25		25SDTF08MPN
	10 mm	21	60	25		25SDTF10MPN
	13 mm	21	60	25		25SDTF13MPN

7,4

 = 43 mm²

95



This coupling system has been developed specifically for the area of breathing protection.

Coupling system with single-hand operation. High Flow valve for optimum flow and low pressure drop. Additional safety locking system. This safety lock prevents unintentional disconnection. To disconnect, the plug must first be pushed further into the coupling before it can be unlocked.

Profile cannot be interconnected with the 96KS series. Tested according DIN EN 14593.

Series 95 with additional end connections available on request.

Dust Protections  (P. 250)
for Coupling Part.-No. SK23S

Working Temperature*
-20°C up to +100°C (NBR)
depending on the medium.

* For temperatures below -20°C and over +100°C and depending on the medium, other seal variants (FKM, EPDM, FFKM) are available.



Working Pressure**

35 bar

** maximum static working pressure with design factor 4 to 1.

Material

Coupling: Brass / Stainless Steel
or Brass nickel plated

Plug: Brass nickel plated

Seals: NBR

Technical Description

Connecting Force 0 bar: 30 N

Connecting Force 6 bar: 105 N

Flow diagrams

Air

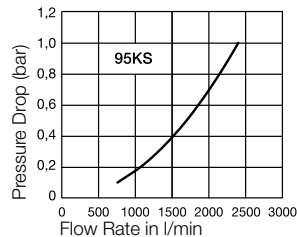



Couplings – with valve

Series 95KS

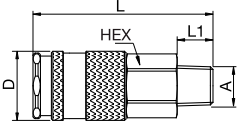
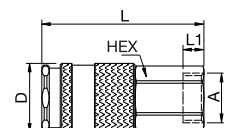
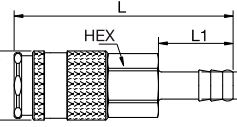
	Connection A	HEX mm	L mm	L1 mm	D mm	Version	Part Number
 <p>Male Thread</p>	R 1/4	19	61	12	23	nickel plated	95KSAK13BPN
	R 1/4	19	61	12	23	Stainless Steel	95KSAK13RPN
	R 3/8	19	60	12	23	nickel plated	95KSAK17BPN
	R 3/8	19	60	12	23	Stainless Steel	95KSAK17RPN
	R 1/2	22	61	17	23	nickel plated	95KSAK21BPN
	R 1/2	22	61	17	23	Stainless Steel	95KSAK21RPN
 <p>Female Thread</p>	G 1/4	19	56	10	23	nickel plated	95KSIW13BPN
	G 1/4	19	56	10	23	Stainless Steel	95KSIW13RPN
	G 3/8	19	55	9	23	nickel plated	95KSIW17BPN
	G 3/8	19	55	9	23	Stainless Steel	95KSIW17RPN
 <p>Hose Barb</p>	6 mm	19	74	25	23	nickel plated	95KSTF06BPN
	8 mm	19	74	25	23	nickel plated	95KSTF08BPN
	9 mm	19	74	25	23	nickel plated	95KSTF09BPN
	9 mm	19	74	25	23	Stainless Steel	95KSTF09RPN
	10 mm	19	74	25	23	nickel plated	95KSTF10BPN
	10 mm	19	74	25	23	Stainless Steel	95KSTF10RPN



Plugs – without valve

Series 95KS

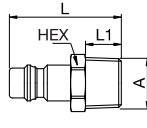
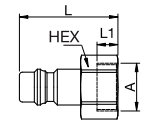
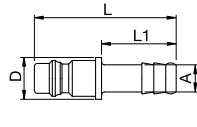
	Connection A	HEX mm	L mm	L1 mm	D mm	Version	Part Number	
 <p>Male Thread</p>	R 1/4	14	38,5	12			95SSAK13MXN	
	R 3/8	17	38,5	12			95SSAK17MXN	
 <p>Female Thread</p>	G 1/4	17	33	9			95SSIW13MXN	
 <p>Hose Barb</p>	6 mm		47,5	25	14		95SSTF06MXN	
	10 mm		47,5	25	14		95SSTF10MXN	

7,4

 = 43 mm²

96



This coupling system has been developed specifically for the area of breathing protection. Coupling system with single-hand operation. High Flow valve for optimum flow and low pressure drop. Additional safety locking system. This safety lock prevents unintentional disconnection. To disconnect, the plug must first be pushed further into the coupling before it can be unlocked. Tested according DIN EN 14593.

Series 96 with additional end connections available on request.

Dust Protections  (P. 250)
for Coupling Part.-No. SK23S
for Plug Part.-No. SK12S

Working Temperature*
-20°C up to +100°C (NBR)
depending on the medium.

* For temperatures below -20°C and over +100°C and depending on the medium, other seal variants (FKM, EPDM, FFKM) are available.



Working Pressure**

35 bar

** maximum static working pressure with design factor 4 to 1.

Material

Coupling: Brass nickel plated

Plug: Brass nickel plated or
Stainless Steel

Seals: NBR or FKM

Technical Description

Connecting Force 0 bar: 30 N

Connecting Force 6 bar: 105 N

Flow diagrams

Air

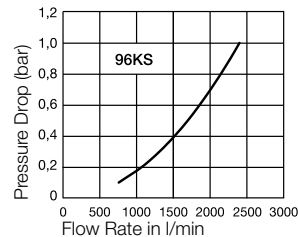



Couplings – with valve

Series 96KS

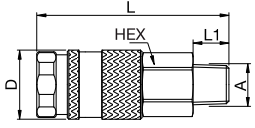
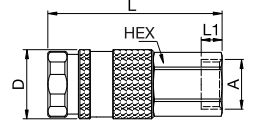
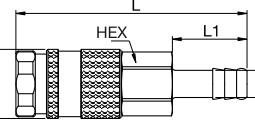
	Connection A	HEX mm	L mm	L1 mm	D mm	Version	Part Number
 <p>Male Thread</p>	R 1/4	19	65	12	23		96KSAK13BPN
	R 3/8	19	64	12	23		96KSAK17BPN
 <p>Female Thread</p>	G 1/4	19	60	10	23		96KSIW13BPN
	G 3/8	19	59	9	23		96KSIW17BPN
 <p>Hose Barb</p>	6 mm	19	78	25	23		96KSTF06BPN
	9 mm	19	78	25	23		96KSTF09BPN
	10 mm	19	78	25	23		96KSTF10BPN
	13 mm	19	78	25	23		96KSTF13BPN



Plugs – without valve

Series 96KS

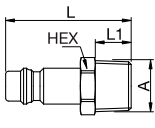
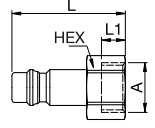
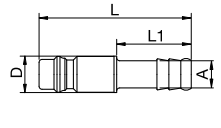
	Connection A	HEX mm	L mm	L1 mm	D mm	Version	Part Number
 <p>Male Thread</p>	R 1/4	14	42	12		Brass	96SSAK13MXN
	R 3/8	17	42	12		Brass	96SSAK17MXN
	G 3/8	19	38	9		Stainless Steel	96SSAW17RXX
 <p>Female Thread</p>	G 1/4	17	38	10		Brass	96SSIW13MXN
	G 3/8	19	38	10		Brass	96SSIW17MXN
 <p>Hose Barb</p>	6 mm		51	25	12	Brass	96SSTF06MXN
	9 mm		51	25	12	Brass	96SSTF09MXN
	13 mm		53	25	12	Brass	96SSTF13MXN

**Other designs in series 14**

The following other designs can be found from page:

► Brass / Steel P. 42

Safety coupling with a self-venting system. Self-venting takes place during disconnection – no risk of pressurised hoses being tossed around. When the sleeve is pulled back, the plug is released yet remains locked in. The coupling valve closes and the air is vented from the air line at the same time. Only then, by operating the sleeve again, can uncoupling take place safely. The system fulfils the requirements of ISO 4414 – increased safety standards in the work place. The plastic sleeve does not scratch working surfaces.

Series 14 with additional end connections available on request.

Safety Note

Reliable functioning can only be guaranteed in conjunction with original Parker Rectus plugs made of steel.

Working Temperature*

-20°C up to +60°C (NBR)
depending on the medium.

* For temperatures below -20°C and over +60°C and depending on the medium, other seal variants (FKM, EPDM, FFKM) are available.

**Working Pressure****

12 bar

** maximum static working pressure with design factor 4 to 1.

Material

Coupling: Brass nickel plated

Plug: Steel nickel plated

Seals: NBR

Technical Description

Connecting Force 0 bar: 40 N

Connecting Force 6 bar: 70 N

Flow diagrams

Air

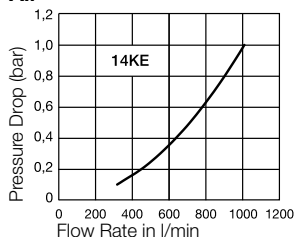



Couplings – with valve

Series 14KE

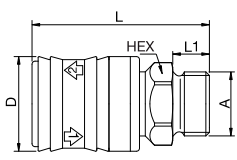
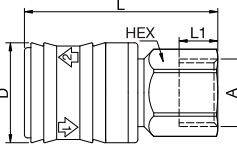
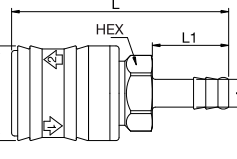
	Connection A	HEX mm	L mm	L1 mm	D mm	Part Number
 <p>Male Thread</p>	R 1/4	22	58	9	31	14KEAK13MPN
	R 3/8	22	58	9	31	14KEAK17MPN
	R 1/2	24	63	12	31	14KEAK21MPN
 <p>Female Thread</p>	G 1/4	22	57	9	31	14KEIW13MPN
	G 3/8	22	57	9	31	14KEIW17MPN
	G 1/2	24	60	12	31	14KEIW21MPN
 <p>Hose Barb</p>	6 mm	22	71	25	31	14KETF06MPN
	8 mm	22	71	25	31	14KETF08MPN
	9 mm	22	71	25	31	14KETF09MPN
	10 mm	22	71	25	31	14KETF10MPN
	13 mm	22	71	25	31	14KETF13MPN



Plugs – without valve

Series 22SF

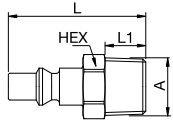
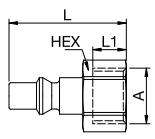
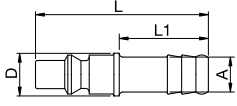
	Connection A	HEX mm	L mm	L1 mm	D mm	Part Number
 <p>Male Thread</p>	R 1/8	12	35	9		22SFAK10SXN
	R 1/4	14	41	12		22SFAK13SXN
	R 3/8	17	41	12		22SFAK17SXN
	R 1/2	22	46	17		22SFAK21SXN
 <p>Female Thread</p>	G 1/4	17	35	9		22SFIW13SXN
	G 3/8	19	35	10		22SFIW17SXN
	G 1/2	24	38	12		22SFIW21SXN
 <p>Hose Barb</p>	6 mm		49	25	12	22SFTF06SXN
	8 mm		49	25	12	22SFTF08SXN
	10 mm		49	25	12	22SFTF10SXN
	13 mm		49	25	12	22SFTF13SXN



Other designs in series 1400

The following other designs can be found from page:

- Brass / Steel P. 50

Technical Description

Safety coupling 1/4" with a self-venting system according to ISO 6150 B. Self-venting takes place during disconnection – no risk of pressurised hoses being tossed around. When the sleeve is pulled back, the plug is released yet remains locked in. The coupling valve closes and the air is vented from the air line at the same time. Only then, by operating the sleeve again, can uncoupling take place safely. The system fulfils the requirements of ISO 4414 – increased safety standards in the work place. DIN EN 983. Ultra High Flow valve for optimum flow and low pressure drop.

Series 1400 with additional end connections available on request.



Working Pressure**

0-12 bar

** maximum static working pressure with design factor 4 to 1.

Material

Coupling: Brass / Steel nickel plated
Plug: Steel nickel plated
Seals: NBR

Technical Description

Connecting Force 0 bar: 35 N
Connecting Force 6 bar: 75 N

Flow diagrams

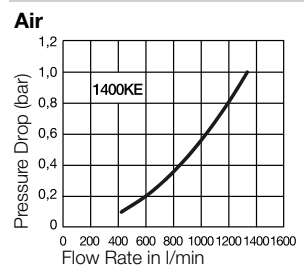

Safety Note

Reliable functioning can only be guaranteed in conjunction with original Parker Rectus plugs made of steel.

Working Temperature*

-20°C up to +100°C (NBR) depending on the medium.

* For temperatures below -20°C and over +100°C and depending on the medium, other seal variants (FKM, EPDM, FFKM) are available.



Couplings – with valve

Series 1400KE

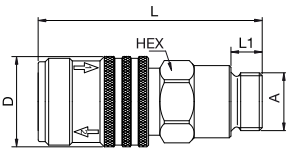
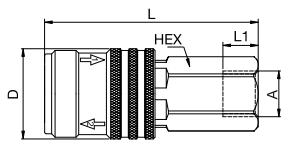
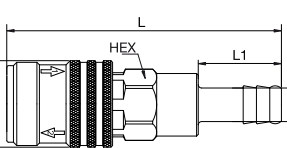
	Connection A	HEX mm	L mm	L1 mm	D mm	Part Number
 <p>Male Thread</p>	G 1/4	19	64,5	9	26	1400KEAW13SPN
	G 3/8	21	64,5	9	26	1400KEAW17SPN
 <p>Female Thread</p>	G 1/4	19	61,5	9	26	1400KEIW13SPN
	G 3/8	19	61,5	9	26	1400KEIW17SPN
 <p>Hose Barb</p>	6 mm	19	82,5	25	26	1400KETF06SPN
	8 mm	19	82,5	25	26	1400KETF08SPN
	10 mm	19	82,5	25	26	1400KETF10SPN



Plugs – without valve

Series 23SF

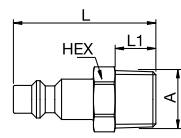
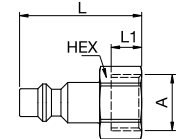
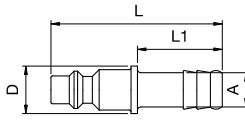
	Connection A	HEX mm	L mm	L1 mm	D mm	Part Number
 <p>Male Thread</p>	R 1/8	13	39	9		23SFAK10SXN
	R 1/4	14	42	12		23SFAK13SXN
	R 3/8	17	42	12		23SFAK17SXN
	R 1/2	22	48	17		23SFAK21SXN
 <p>Female Thread</p>	G 1/8	14	36	9		23SFIW10SXN
	G 1/4	17	36	9		23SFIW13SXN
	G 3/8	19	36	9		23SFIW17SXN
	G 1/2	24	39	12		23SFIW21SXN
 <p>Hose Barb</p>	6 mm		51	14	25	23SFTF06SXN
	8 mm		51	14	25	23SFTF08SXN
	9 mm		51	14	25	23SFTF09SXN
	10 mm		51	14	25	23SFTF10SXN
	13 mm		51	15	25	23SFTF13SXN

**Other designs in series 24**

The following other designs can be found from page:

► Brass / Steel P. 52

Safety coupling with a self-venting system according to ISO 6150 B. Self-venting takes place during disconnection – no risk of pressurised hoses being tossed around. When the sleeve is pulled back, the plug is released yet remains locked in. The coupling valve closes and the air is vented from the air line at the same time. Only then, by operating the sleeve again, can uncoupling take place safely. The system fulfils the requirements of ISO 4414 – increased safety standards in the work place. The plastic sleeve does not scratch working surfaces.

Series 24 with additional end connections available on request.

Safety Note

Reliable functioning can only be guaranteed in conjunction with original Parker Rectus plugs made of steel.

Working Temperature*

-20°C up to +60°C (NBR) depending on the medium.

* For temperatures below -20°C and over +60°C and depending on the medium, other seal variants (FKM, EPDM, FFKM) are available.

**Working Pressure****

12 bar

** maximum static working pressure with design factor 4 to 1.

Material

Coupling: Brass nickel plated

Plug: Steel nickel plated

Seals: NBR

Technical Description

Connecting Force 0 bar: 40 N

Connecting Force 6 bar: 80 N

Flow diagrams

Air

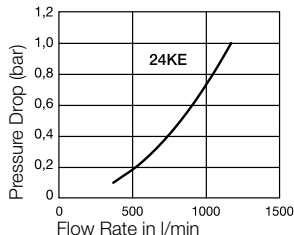



Couplings – with valve

Series 24KE

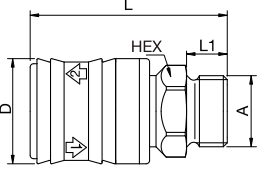
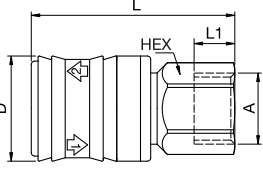
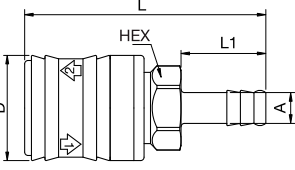
	Connection A	HEX mm	L mm	L1 mm	D mm	Part Number
 <p>Male Thread</p>	R 1/4	22	58	9	31	24KEAK13MPN
	R 3/8	22	58	9	31	24KEAK17MPN
	R 1/2	24	63	12	31	24KEAK21MPN
 <p>Female Thread</p>	G 1/4	22	57	9	31	24KEIW13MPN
	G 3/8	22	57	9	31	24KEIW17MPN
 <p>Hose Barb</p>	6 mm	22	71	25	31	24KETF06MPN
	8 mm	22	71	25	31	24KETF08MPN
	9 mm	22	71	25	31	24KETF09MPN
	10 mm	22	71	25	31	24KETF10MPN
	13 mm	22	71	25	31	24KETF13MPN



Plugs – without valve

Series 23SF

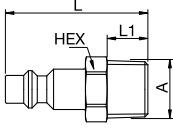
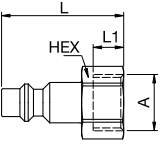
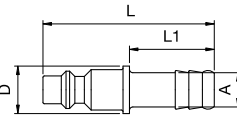
	Connection A	HEX mm	L mm	L1 mm	D mm	Part Number
 <p>Male Thread</p>	R 1/8	13	39	9		23SFAK10SXN
	R 1/4	14	42	12		23SFAK13SXN
	R 3/8	17	42	12		23SFAK17SXN
	R 1/2	22	48	17		23SFAK21SXN
 <p>Female Thread</p>	G 1/8	14	36	9		23SFIW10SXN
	G 1/4	17	36	9		23SFIW13SXN
	G 3/8	19	36	9		23SFIW17SXN
	G 1/2	24	36	12		23SFIW21SXN
 <p>Hose Barb</p>	6 mm		51	25	14	23SFTF06SXN
	8 mm		51	25	14	23SFTF08SXN
	9 mm		51	25	14	23SFTF09SXN
	10 mm		51	25	14	23SFTF10SXN
	13 mm		51	25	14	23SFTF13SXN

**Other designs in series 26**

The following other designs can be found from page:

► Brass / Steel P. 58

Safety coupling with a self-venting system. Self-venting takes place during disconnection – no risk of pressurised hoses being tossed around. When the sleeve is pulled back, the plug is released yet remains locked in. The coupling valve closes and the air is vented from the air line at the same time. Only then, by operating the sleeve again, can uncoupling take place safely. The system fulfils the requirements of ISO 4414 – increased safety standards in the work place. The plastic sleeve does not scratch working surfaces.

Series 26 with additional end connections available on request.

Safety Note

Reliable functioning can only be guaranteed in conjunction with original Parker Rectus plugs made of steel.

Working Temperature*

-20°C up to +60°C (NBR)
depending on the medium.

* For temperatures below -20°C and over +60°C and depending on the medium, other seal variants (FKM, EPDM, FFKM) are available.

**Working Pressure****

12 bar

** maximum static working pressure with design factor 4 to 1.

Material

Coupling: Brass nickel plated

Plug: Steel zinc plated

Seals: NBR

Technical Description

Connecting Force 0 bar: 40 N

Connecting Force 6 bar: 100 N

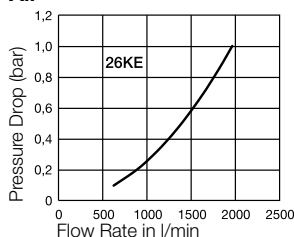
Flow diagrams**Air**



Couplings – with valve

Series 26KE

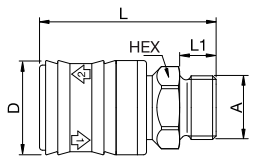
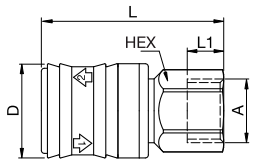
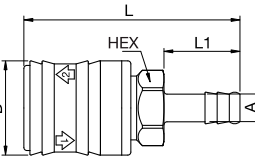
	Connection A	HEX mm	L mm	L1 mm	D mm	Part Number
 <p>Male Thread</p>	G 1/4	22	55	9	31	26KEAW13MPN
	G 3/8	22	55	9	31	26KEAW17MPN
	G 1/2	24	58	12	31	26KEAW21MPN
 <p>Female Thread</p>	G 1/4	22	57	9	31	26KEIW13MPN
	G 3/8	22	57	9	31	26KEIW17MPN
	G 1/2	24	60	12	31	26KEIW21MPN
 <p>Hose Barb</p>	6 mm	22	71	25	31	26KETF06MPN
	8 mm	22	71	25	31	26KETF08MPN
	9 mm	22	71	25	31	26KETF09MPN
	10 mm	22	71	25	31	26KETF10MPN
	13 mm	22	71	25	31	26KETF13MPN



Plugs – without valve

Series 25SF

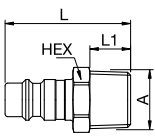
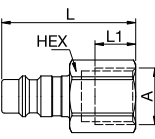
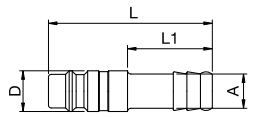
	Connection A	HEX mm	L mm	L1 mm	D mm	Part Number
 <p>Male Thread</p>	R 1/8	13	33	9		25SFAK10SXZ
	R 1/4	14	37	12		25SFAK13SXZ
	R 3/8	17	37	12		25SFAK17SXZ
	R 1/2	22	43	17		25SFAK21SXZ
 <p>Female Thread</p>	G 1/8	14	30	7		25SFIW10SXZ
	G 1/4	17	33	9		25SFIW13SXZ
	G 3/8	19	33	9		25SFIW17SXZ
	G 1/2	24	36	12		25SFIW21SXZ
 <p>Hose Barb</p>	6 mm		48	25	12	25SFTF06SXZ
	8 mm		48	25	12	25SFTF08SXZ
	9 mm		48	25	12	25SFTF09SXZ
	10 mm		48	25	12	25SFTF10SXZ
	13 mm		48	25	12	25SFTF13SXZ



Other designs in series 1600

The following other designs can be found from page:

- Brass / Steel P. 76

Safety coupling with a self-venting system. Self-venting takes place during disconnection – no risk of pressurised hoses being tossed around. When the sleeve is pulled back, the plug is released yet remains locked in. The coupling valve closes and the air is vented from the air line at the same time. Only then, by operating the sleeve again, can uncoupling take place safely. The system fulfils the requirements of ISO 4414 – increased safety standards in the work place. DIN EN 983. Ultra High Flow valve for optimum flow and low pressure drop.

Series 1600 with additional end connections available on request.

Safety Note

Reliable functioning can only be guaranteed in conjunction with original Parker Rectus plugs made of steel.

Working Temperature*

-20°C up to +100°C (NBR) depending on the medium.

* For temperatures below -20°C and over +100°C and depending on the medium, other seal variants (FKM, EPDM, FFKM) are available.



Working Pressure**

2-12 bar

** maximum static working pressure with design factor 4 to 1.

Material

Coupling: Brass / Steel nickel plated
Plug: Steel zinc plated
Seals: NBR

Technical Description

Connecting Force 0 bar: 30 N
Connecting Force 6 bar: 75 N

Flow diagrams

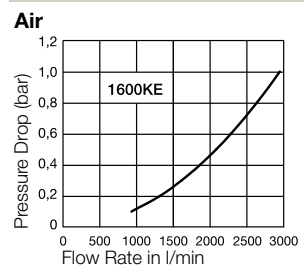



Couplings – with valve

Series 1600KE

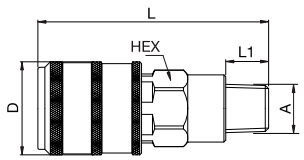
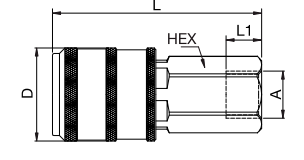
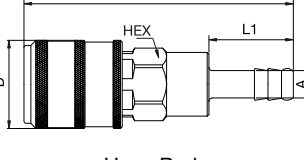
	Connection A	HEX mm	L mm	L1 mm	D mm	Part Number
 <p>Male Thread</p>	R 1/4	19	64,5	12	26	1600KEAK13SPN
	R 3/8	19	64,5	12	26	1600KEAK17SPN
	R 1/2	22	59	17	26	1600KEAK21SPN
 <p>Female Thread</p>	G 1/4	19	59	10	26	1600KEIW13SPN
	G 3/8	19	59	9	26	1600KEIW17SPN
	G 1/2	24	61,5	12	26	1600KEIW21SPN
 <p>Hose Barb</p>	6 mm	19	79,5	25	26	1600KETF06SPN
	9 mm	19	79,5	25	26	1600KETF09SPN
	10 mm	19	79,5	25	26	1600KETF10SPN
	13 mm	19	79,5	25	26	1600KETF13SPN



Plugs – without valve

Series 25SF

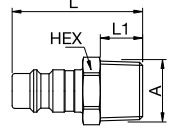
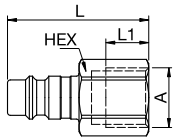
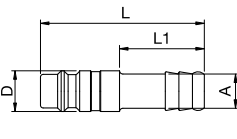
	Connection A	HEX mm	L mm	L1 mm	D mm	Part Number
 <p>Male Thread</p>	R 1/8	13	33	9		25SFAK10SXZ
	R 1/4	14	37	12		25SFAK13SXZ
	R 3/8	17	37	12		25SFAK17SXZ
	R 1/2	22	43	17		25SFAK21SXZ
 <p>Female Thread</p>	G 1/8	14	30	7		25SFIW10SXZ
	G 1/4	17	38,5	9		25SFIW13SXZ
	G 3/8	19	39,5	9		25SFIW17SXZ
	G 1/2	24	44	12		25SFIW21SXZ
 <p>Hose Barb</p>	6 mm		48	25	12	25SFTF06SXZ
	8 mm		48	25	12	25SFTF08SXZ
	9 mm		48	25	12	25SFTF09SXZ
	10 mm		48	25	12	25SFTF10SXZ
	13 mm		48	25	12	25SFTF13SXZ

10 = 80 mm²**1700**

Safety coupling with a self-venting system. Self-venting takes place during disconnection – no risk of pressurised hoses being tossed around. When the sleeve is pulled back, the plug is released yet remains locked in. The coupling valve closes and the air is vented from the air line at the same time. Only then, by operating the sleeve again, can uncoupling take place safely. The system fulfils the requirements of ISO 4414 – increased safety standards in the work place. DIN EN 983. Ultra High Flow valve for optimum flow and low pressure drop.

Series 1700 with additional end connections available on request.

Safety Note

Reliable functioning can only be guaranteed in conjunction with original Parker Rectus plugs made of steel.

Working Temperature*

-20°C up to +100°C (NBR)
depending on the medium.

* For temperatures below -20°C and over +100°C and depending on the medium, other seal variants (FKM, EPDM, FFKM) are available.

Other designs in series 1700

The following other designs can be found from page:

► Brass / Steel P. 90

**Working Pressure****

0-12 bar

** maximum static working pressure with design factor 4 to 1.

Material

Coupling: Brass / Steel nickel plated
Plug: Steel nickel plated
Seals: NBR

Technical Description

Connecting Force 0 bar: 47 N
Connecting Force 6 bar: 126 N

Flow diagrams

Air

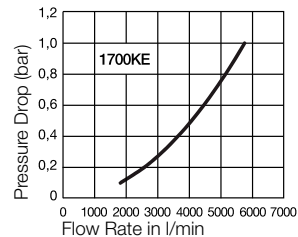



Couplings – with valve

Series 1700KE

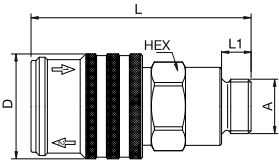
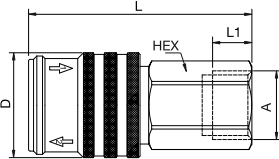
	Connection A	HEX mm	L mm	L1 mm	D mm	Part Number
 <p>Male Thread</p>	G 3/8	24	67	9	32	1700KEAW17SPN
	G 1/2	24	70	12	32	1700KEAW21SPN
	G 3/4	30	74	16	32	1700KEAW26SPN
 <p>Female Thread</p>	G 3/8	24	64,5	12	32	1700KEIW17SPN
	G 1/2	24	68	12	32	1700KEIW21SPN
	G 3/4	32	74	16	32	1700KEIW26SPN



Plugs – without valve

Series 27SF

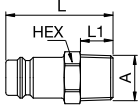
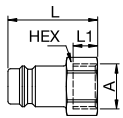
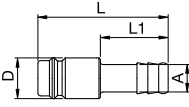
	Connection A	HEX mm	L mm	L1 mm	D mm	Part Number
 <p>Male Thread</p>	R 1/4	17	40	12		27SFAK13SXN
	R 3/8	17	40	12		27SFAK17SXN
	R 1/2	22	45	17		27SFAK21SXN
	R 3/4	27	48	19		27SFAK26SXN
 <p>Female Thread</p>	G 1/4	17	33	9		27SFIW13SXN
	G 3/8	19	33	9		27SFIW17SXN
	G 1/2	24	37	12		27SFIW21SXN
	G 3/4	32	42	16		27SFIW26SXN
 <p>Hose Barb</p>	6 mm		48	25	15	27SFTF06SXN
	8 mm		48	25	15	27SFTF08SXN
	9 mm		48	25	15	27SFTF09SXN
	10 mm		48	25	15	27SFTF10SXN
	13 mm		48	25	15	27SFTF13SXN
	16 mm		49	25	18	27SFTF16SXN
	19 mm		49	25	18	27SFTF19SXN

5 = 20 mm²**21****Other designs in series 21**

The following other designs can be found from page:

- | | |
|-------------------|--------|
| ▶ Brass / Steel | P. 26 |
| ▶ Stainless Steel | P. 140 |
| ▶ Thermoplastic | P. 176 |
| ▶ Safety | P. 210 |

Interchangeability (KA only)

- Rectus Design

Coded industrial coupling system developed on the basis of series 21 with above-average flow rate for liquid and gaseous media.

Coupling system with single-hand operation. The mechanical coding of the coupling and plug offers a guarantee for avoiding mix-ups between media when coupling, which is complemented by the color coding of the anodised sleeves.

Double shut-off version available on request.

Working Temperature*

-20°C up to +100°C (NBR)
depending on the medium.

* For temperatures below -20°C and over +100°C and depending on the medium, other seal variants (FKM, EPDM, FFKM) are available.

**Working Pressure****

35 bar

** maximum static working pressure with design factor 4 to 1.

Material

Coupling: Brass or Brass nickel plated

Plug: Brass nickel plated

Seals: NBR

Technical Description

Connecting Force 0 bar: 35 N

Connecting Force 6 bar: 60 N

Vacuum Coupling: 96%

Vacuum connected: 96%

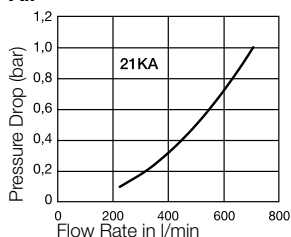
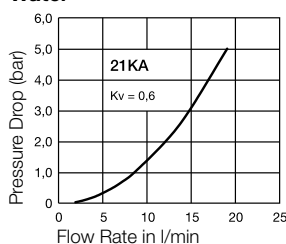
Flow diagrams**Air****Water**



Couplings – with valve

Series 21KA

	Connection A	HEX mm	L mm	L1 mm	L2 mm	D mm	G mm	Version	Part Number	Part Number	Part Number	Part Number
 Male Thread	G 1/8	14	47	7		16		nickel plated	21KAAW10MPN0	21KAAW10MPN3	21KAAW10MPN6	21KAAW10MPN8
	G 1/4	17	47	9		16		nickel plated	21KAAW13MPN0	21KAAW13MPN3	21KAAW13MPN6	21KAAW13MPN8
 Female Thread	G 1/8	14	47	7		16		nickel plated	21KAIW10MPN0	21KAIW10MPN3	21KAIW10MPN6	21KAIW10MPN8
	G 1/4	17	47	9		16		nickel plated	21KAIW13MPN0	21KAIW13MPN3	21KAIW13MPN6	21KAIW13MPN8
 Hose Barb	4 mm	14	69	17		16		nickel plated	21KATF04MPN0	21KATF04MPN3	21KATF04MPN6	21KATF04MPN8
	6 mm	14	69	17		16		nickel plated	21KATF06MPN0	21KATF06MPN3	21KATF06MPN6	21KATF06MPN8
 with Plastic Hose Connection	4 x 6 mm	14	51	7	6	16	M10x1	nickel plated	21KAKO06MPN0	21KAKO06MPN3	21KAKO06MPN6	21KAKO06MPN8



Plugs – without valve

Series 21KA

	Connection A	HEX mm	L mm	L1 mm	L2 mm	D mm	G mm	Version	Part Number	Part Number	Part Number	Part Number
 Male Thread	G 1/8	17	39,5	7				nickel plated	21SFAW10MXN0	21SFAW10MXN3	21SFAW10MXN6	21SFAW10MXN8
	G 1/4	17	41,5	9				nickel plated	21SFAW13MXN0	21SFAW13MXN3	21SFAW13MXN6	21SFAW13MXN8
 Female Thread	G 1/8	17	38,5	5				nickel plated	21SFIW10MXN0	21SFIW10MXN3	21SFIW10MXN6	21SFIW10MXN8
	G 1/4	17	39	7				nickel plated	21SFIW13MXN0	21SFIW13MXN3	21SFIW13MXN6	21SFIW13MXN8
 Hose Barb	6 mm		47	17		15		nickel plated	21SFTF06MXN0	21SFTF06MXN3	21SFTF06MXN6	21SFTF06MXN8

**Other designs in series 25**

The following other designs can be found from page:

- | | |
|-----------------------|--------|
| ▶ Brass / Steel | P. 70 |
| ▶ Stainless Steel | P. 150 |
| ▶ Safety | P. 214 |
| ▶ Safety Self-Venting | P. 230 |

Interchangeability (KA only)

- Rectus Design

Coded industrial coupling system developed on the basis of series 25.
Coupling system with single-hand operation. High Flow valve for optimum flow and low pressure drop. The mechanical coding of the coupling and plug offers a guarantee for avoiding mix-ups between media when coupling, which is complemented by the color coding of the anodised sleeves. Double shut-off and straight-through couplings are available upon request. Cannot be interconnected with the Rectus standard 25 series.

Working Temperature*

-20°C up to +100°C (NBR)
depending on the medium.

* For temperatures below -20°C and over +100°C and depending on the medium, other seal variants (FKM, EPDM, FFKM) are available.

**Working Pressure****

35 bar

** maximum static working pressure with design factor 4 to 1.

Material

Coupling: Brass or Brass nickel plated

Plug: Brass nickel plated

Seals: NBR

Technical Description

Connecting Force 0 bar: 40 N

Connecting Force 6 bar: 120 N

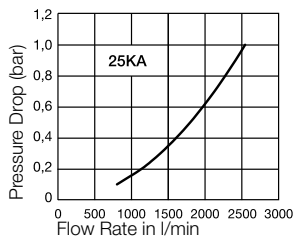
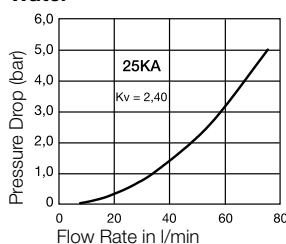
Flow diagrams**Air****Water**



Couplings – with valve

Series 25KA

	Connection A	HEX mm	L mm	L1 mm	L2 mm	D mm	G mm	Version				
									Part Number	Part Number	Part Number	Part Number
 Male Thread	G 1/4	19	57,5	12		23		nickel plated	25KAAW13BPN0	25KAAW13BPN3	25KAAW13BPN6	25KAAW13BPN8
	G 3/8	19	57,5	12		23		nickel plated	25KAAW17BPN0	25KAAW17BPN3	25KAAW17BPN6	25KAAW17BPN8
	G 1/2	22	61	17		23		nickel plated	25KAAW21BPN0	25KAAW21BPN3	25KAAW21BPN6	25KAAW21BPN8
 Female Thread	G 1/4	19	55	10		23		nickel plated	25KAIW13BPN0	25KAIW13BPN3	25KAIW13BPN6	25KAIW13BPN8
	G 3/8	19	55	9		23		nickel plated	25KAIW17BPN0	25KAIW17BPN3	25KAIW17BPN6	25KAIW17BPN8
 Hose Barb	9 mm	19	74	25		23		nickel plated	25KATF09BPN0	25KATF09BPN3	25KATF09BPN6	25KATF09BPN8
	13 mm	19	74	25		23		nickel plated	25KATF13BPN0	25KATF13BPN3	25KATF13BPN6	25KATF13BPN8



Plugs – without valve

Series 26SF

	Connection A	HEX mm	L mm	L1 mm	L2 mm	D mm	G mm	Version				
									Part Number	Part Number	Part Number	Part Number
 Male Thread	G 1/4	17	36,5	9				nickel plated	26SFAW13MXN0	26SFAW13MXN3	26SFAW13MXN6	26SFAW13MXN8
	G 3/8	19	41,5	12				nickel plated	26SFAW17MXN0	26SFAW17MXN3	26SFAW17MXN6	26SFAW17MXN8
 Female Thread	G 1/4	17	36,5	8				nickel plated	26SFIW13MXN0	26SFIW13MXN3	26SFIW13MXN6	26SFIW13MXN8
 Hose Barb	6 mm		50,5	25		15		nickel plated	26SFTF06MXN0	26SFTF06MXN3	26SFTF06MXN6	26SFTF06MXN8
	9 mm		50,5	25		15		nickel plated	26SFTF09MXN0	26SFTF09MXN3	26SFTF09MXN6	26SFTF09MXN8

Components

Threaded Nut



DIN EN 560
(left handed thread marked)

- * only for STP13/09
- ** only to use with Male x Male Nipples marked

Connection A	HEX mm	L mm	Version	Part Number
G 1/8 right	12	11	Brass	UR10
G 1/4 right	17	15,5	Brass	UR13
G 3/8 right	19	16,5	Brass	UR17
G 1/4 r. f. 9 mm	17	15,5	Brass	UR13/9 *
G 1/2 right	24	20,5	Brass	UR21
G 1/4 left	17	15,5	Brass	UL13
G 3/8 left	19	16,5	Brass	UL17 **
G 1/2 left	24	20,5	Brass	UL21

Hose Tail, short



- * UR13/9 required

Connection A	HEX mm	L mm	Version	Part Number
4 mm for G 1/4		30,5	Brass	STP13/04
6 mm for G 1/4		35,5	Brass	STP13/06
9 mm for G 1/4		35,5	Brass	STP13/09 *
6 mm for G 3/8		36	Brass	STP17/06
9 mm for G 3/8		36	Brass	STP17/09
9 mm for G 1/2		38	Brass	STP21/09
13 mm for G 1/2		44	Brass	STP21/13

Hose Tail, long



DIN EN 560

Connection A	HEX mm	L mm	Version	Part Number
4 mm for G 1/4		47	Brass	STD13/04
6 mm for G 1/4		47	Brass	STD13/06
4 mm for G 3/8		47,5	Brass	STD17/04
6 mm for G 3/8		47,5	Brass	STD17/06
9 mm for G 3/8		47,5	Brass	STD17/09

Hose Tail Barb

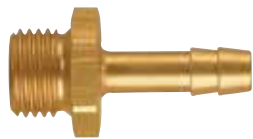

with Male Thread
(* inner cone 45°)

Connection A	HEX mm	L mm	Version	Part Number
M 5, 3 mm	7	15,5	Brass	GT05/03
M 5, 4 mm	7	15,5	Brass	GT05/04
M 6, 4 mm	8	23	Brass	GT06/04
G 1/8, 4 mm *	14	28	Brass	GT10/04
G 1/8, 6 mm *	14	33	Brass	GT10/06
G 1/8, 6 mm *	14	33	AISI 303	GT10/06R
G 1/8, 6 mm *	14	33	AISI 316 L	GT10/06E
G 1/8, 8 mm *	14	33	Brass	GT10/08
G 1/8, 9 mm *	14	33	Brass	GT10/09
G 1/4, 4 mm *	17	29,5	Brass	GT13/04
G 1/4, 6 mm *	17	34,5	Brass	GT13/06
G 1/4, 8 mm *	17	34,5	Brass	GT13/08
G 1/4, 9 mm *	17	34,5	Brass	GT13/09
G 1/4, 9 mm *	17	34,5	AISI 303	GT13/09R
G 1/4, 13 mm *	17	41,5	Brass	GT13/13
G 3/8, 6 mm *	19	36	Brass	GT17/06
G 3/8, 8 mm *	19	36	Brass	GT17/08
G 3/8, 9 mm *	19	36	Brass	GT17/09
G 3/8, 9 mm *	19	36	AISI 303	GT17/09R
G 3/8, 13 mm *	19	42	Brass	GT17/13
G 1/2, 6 mm *	24	39	Brass	GT21/06
G 1/2, 9 mm *	24	39	Brass	GT21/09
G 1/2, 13 mm *	24	45	Brass	GT21/13
G 1/2, 13 mm *	24	45	AISI 303	GT21/13R
G 3/4, 13 mm *	32	48,5	Brass	GT26/13
G 3/4, 16 mm *	32	56,5	Brass	GT26/16
G 3/4, 19 mm *	32	56,5	Brass	GT26/19
G 1, 25 mm *	36	67,5	Brass	GT33/25

Hose Tail Barb

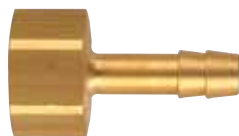

with Female Thread

	Connection A	HEX mm	L mm	Version	Part Number
	G 1/8, 6 mm	12	31	Brass	GI10/06
	G 1/8, 8 mm	12	31	Brass	GI10/08
	G 1/4, 6 mm	17	33	Brass	GI13/06
	G 1/4, 8 mm	17	33	Brass	GI13/08
	G 1/4, 9 mm	17	33	Brass	GI13/09
	G 1/4, 13 mm	17	39	Brass	GI13/13
	G 3/8, 6 mm	19	33	Brass	GI17/06
	G 3/8, 8 mm	19	33	Brass	GI17/08
	G 3/8, 9 mm	19	33	Brass	GI17/09
	G 3/8, 13 mm	19	40	Brass	GI17/13
	G 1/2, 6 mm	24	36	Brass	GI21/06
	G 1/2, 8 mm	24	36	Brass	GI21/08
	G 1/2, 9 mm	24	36	Brass	GI21/09
	G 1/2, 13 mm	24	43	Brass	GI21/13

Hose Repairer



* DIN EN 560
** for Hard Hoses

	Connection A	HEX mm	L mm	Version	Part Number
	4 mm		50	Brass	DS04/04P **
	6 mm		72	Brass	DS06/06 *
	8 mm		72	Brass	DS08/08 *
	9 mm		72	Brass	DS09/09 *
	13 mm		74	Brass	DS13/13

Hose Repairer, short



	Connection A	HEX mm	L mm	Version	Part Number
	4 mm		19	Brass	DK04/04
	6 mm		19	Brass	DK06/06

Male x Male Nipple

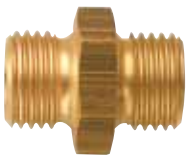
	Connection A	HEX mm	L mm	Version	Part Number
	G 1/8 x G 1/8 *	14	19	Brass	DN10/10
	R 1/8 x R 1/8 con.	12	21	Brass	DN10/10K
	G 1/8 x G 1/4 *	17	19,5	Brass	DN10/13
	G 1/8 x G 3/8 **	19	21	Brass	DN10/17
	G 1/4 x G 1/4 *	17	22	Brass	DN13/13
	G 1/4 x G 1/4 *	17	22	AISI 303	DN13/13R
	R 1/4 x R 1/4 con.	14	30	Brass	DN13/13K
	G 1/4 x G 3/8 **	19	22,5	Brass	DN13/17
	G 1/4 x G 3/8 **	19	22,5	AISI 303	DN13/17R
	G 1/4 x G 3/8 ext. **	19	24,5	Brass	DN13/17V
	G 1/4 x G 1/2 *	24	25,5	Brass	DN13/21
	G 3/8 x G 3/8 **	19	23	Brass	DN17/17
	G 3/8 x G 3/8 **	19	23	AISI 303	DN17/17R
	G 3/8 x G 3/8 ext. **	19	27	Brass	DN17/17V
	R 3/8 x R 3/8 con.	17	30	Brass	DN17/17K
	G 3/8 x G 1/2 **	24	26	Brass	DN17/21
	G 3/8 x G 1/2 **	24	26	AISI 303	DN17/21R
	G 3/8 x G 3/4 **	32	29,5	Brass	DN17/26
	G 1/2 x G 1/2 *	24	28	Brass	DN21/21
	G 1/2 x G 1/2 *	24	28	AISI 303	DN21/21R
R 1/2 x R 1/2 con.	22	34	Brass	DN21/21K	
G 1/2 x G 3/4 *	32	31,5	Brass	DN21/26	
G 1/2 x G 1 *	36	36,5	Brass	DN21/33	
G 3/4 x G 3/4 *	32	33	Brass	DN26/26	
G 3/4 x G 1 *	36	34	Brass	DN26/33	
G 1 x G 1 *	36	37	Brass	DN33/33	

* Inner Cone 45°

** Inner Cone 45°, useable only together with Threaded Nut UR17S

Male x Male Nipple adjustable

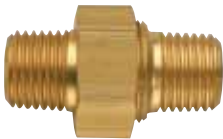
	Connection A	HEX mm	L mm	Version	Part Number
	R 1/8 x R 1/8	15	27	Brass	LD10/10K
	R 1/4 x R 1/4	19	34	Brass	LD13/13K
	R 3/8 x R 3/8	22	37	Brass	LD17/17K
	R 1/2 x R 1/2	27	44,5	Brass	LD21/21K
	R 3/4 x R 3/4	36	53	Brass	LD26/26K
	R 1 x R 1	46	64	Brass	LD33/33K

Reducing Bush, short

	Connection A	HEX mm	L mm	Version	Part Number
	M 5 i. x G 1/8 o.	14	11	Brass	RK05/10
	M 5 i. x G 1/4 o.	17	12,5	Brass	RK05/13
	G 1/8 i. x G 1/4 o.	17	12,5	Brass	RK10/13
	G 1/8 i. x G 3/8 o.	19	13	Brass	RK10/17
	G 1/8 i. x G 1/2 o.	24	17	Brass	RK10/21
	G 1/4 i. x G 3/8 o.	19	14	Brass	RK13/17
	G 1/4 i. x G 3/8 o.	19	14	AISI 303	RK13/17R
	G 1/4 i. x G 1/2 o.	24	17	Brass	RK13/21
	G 3/8 i. x G 1/2 o.	24	17	Brass	RK17/21
	G 3/8 i. x G 1/2 o.	24	17	AISI 303	RK17/21R
	G 3/8 i. x G 3/4 o.	32	18	Brass	RK17/26
	G 1/2 i. x G 3/4 o.	32	20,5	Brass	RK21/26
	G 1/2 i. x G 1 o.	36	21,5	Brass	RK21/33
	G 3/4 i. x G 1 o.	36	21,5	Brass	RK26/33

Reducing Bush, long

	Connection A	HEX mm	L mm	Version	Part Number
	M 5 o. x M 5 i.	8	15	Brass	RL05/05
	M 5 o. x G 1/8 i.	14	17	Brass	RL05/10
	G 1/8 o. x G 1/8 i. *	14	23	Brass	RL10/10
	G 1/8 o. x G 1/4 i. *	17	26	Brass	RL10/13
	G 1/4 o. x G 1/8 i. *	17	26	Brass	RL13/10
	G 1/4 o. x G 1/4 i. *	17	28	Brass	RL13/13
	G 1/4 o. x G 3/8 i. *	19	29	Brass	RL13/17
	G 3/8 o. x G 1/4 i. *	19	29	Brass	RL17/13
	G 3/8 o. x G 3/8 i. *	19	29	Brass	RL17/17
	G 3/8 o. x G 1/2 i. *	24	32	Brass	RL17/21
	G 1/2 o. x G 3/8 i. *	24	34	Brass	RL21/17
	G 1/2 o. x G 1/2 i. *	24	34	Brass	RL21/21
	G 1/2 o. x G 3/4 i. *	32	31	Brass	RL21/26

* Inner Cone 45°

Female x Female Socket

	Connection A	HEX mm	L mm	Version	Part Number
	M 5	8	12	Brass	MU05
	G 1/8	14	22	Brass	MU10
	G 1/4	17	26	Brass	MU13
	G 3/8	22	26	Brass	MU17
	G 1/2	27	30	Brass	MU21
	G 3/4	32	36	Brass	MU26
	G 1	41	40	Brass	MU33

90° Elbow

	Connection A	HEX mm	L mm	Version	Part Number
	G 1/8		16	Brass	WS10
	G 1/4		22	Brass	WS13
	G 3/8		27	Brass	WS17

Bulkhead Lock Nut

	Connection A	HEX mm	L mm	Version	Part Number
	G 1/8	15		Brass	KM10W
	G 1/4	17		Brass	KM13W
	G 3/8	22		Brass	KM17W
	G 1/2	27		Brass	KM21W
	G 3/4	30		Brass	KM26W

Blanking Plug

	Connection A	HEX mm	L mm	Version	Part Number
 Socket Pipe (DIN 908)	M 5 (head pipe)	8	8	Brass	VZ05
	G 1/8	5	11	Brass	VZ10
	G 1/4	6	15	Brass	VZ13
	G 3/8	8	15	Brass	VZ17
	G 1/2	10	18	Brass	VZ21
	G 3/4	12	20	Brass	VZ26

Blanking Plug

	Connection A	HEX mm	L mm	Version	Part Number
 <p>Tapered, with Socket Pipe (DIN 906)</p>	R 1/8	5		Brass	VK10
	R 1/4	7		Brass	VK13
	R 3/8	8		Brass	VK17

Washer, PVC

	Connection A	HEX mm	L mm	Version	Part Number
	for M 5				PD05
	for G 1/8				PD10
	for G 1/4				PD13
	for G 3/8				PD17
	for G 1/2				PD21
	for G 3/4				PD26

Washer, Fiber

	Connection A	HEX mm	L mm	Version	Part Number
	for M 5				FD05
	for G 1/8				FD10
	for G 1/4				FD13
	for G 3/8				FD17
	for G 1/2				FD21
	for G 3/4				FD26

Washer, Aluminium

	Connection A	HEX mm	L mm	Version	Part Number
	for G 1/8				AD10
	for G 1/4				AD13
	for G 3/8				AD17
	for G 1/2				AD21
	for G 3/4				AD26

Female Stud Fitting

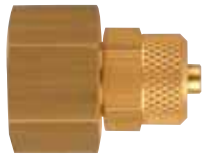
	Connection A	HEX mm	L mm	Version	Part Number
	G 1/8, 4 x 6 mm	14	23	Brass	MV10/06
	G 1/4, 4 x 6 mm	17	25	Brass	MV13/06
	G 1/4, 6 x 8 mm	17	25	Brass	MV13/08

Swivelling Spring Guard

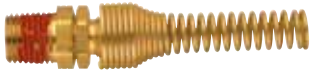
	Connection A	HEX mm	L mm	Version	Part Number
	R 1/8, 3,1 x 4,7 mm	11		Brass	DV10/05
	R 1/4, 4,8 x 6,3 mm	14		Brass	DV13/06
	R 1/4, 6,3 x 7,9 mm	14		Brass	DV13/08
	R 1/4, 7,9 x 9,5 mm	15		Brass	DV13/10

Hose Tail Elbow, Swivelling

	Connection A	HEX mm	L mm	Version	Part Number
	M 5, f. LW 3 mm	8	18,5	Brass	WT05/03
	M 5, f. LW 4 mm	8	18,5	Brass	WT05/04

Stud Fitting

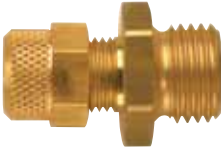
	Connection A	HEX mm	L mm	Version	Part Number
	M 5, 3 x 5 mm	7	20	Brass	EV05/05
	M 5, 3 x 5 mm	7	20	AISI 303	EV05/05R
	M 5, 4 x 6 mm	8	21	Brass	EV05/06
	M 5, 4 x 6 mm	8	21	AISI 303	EV05/06R
	G 1/8, 4 x 6 mm	12	25	Brass	EV10/06
	G 1/8, 4 x 6 mm	12	25	AISI 303	EV10/06R
	G 1/8, 6 x 8 mm	14	24	Brass	EV10/08
	G 1/8, 6 x 8 mm	14	24	AISI 303	EV10/08R
	G 1/4, 4 x 6 mm	17	26	Brass	EV13/06
	G 1/4, 6 x 8 mm	17	26	Brass	EV13/08
	G 1/4, 8 x 10 mm	17	31	Brass	EV13/10
	G 1/4, 9 x 12 mm	17	31	Brass	EV13/12

Fixed Spring Guard

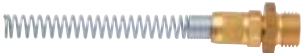
	Connection A	HEX mm	L mm	Version	Part Number
 with Spring Guard	G 1/8, 4 x 6 mm	12	103	Brass	SV10/06
	G 1/8, 6 x 8 mm	12	106	Brass	SV10/08
	G 1/4, 4 x 6 mm	17	103	Brass	SV13/06
	G 1/4, 6 x 8 mm	17	106	Brass	SV13/08
	G 1/4, 8 x 10 mm	17	119	Brass	SV13/10
	G 1/4, 9 x 12 mm	17	123	Brass	SV13/12
	G 3/8, 9 x 12 mm *	19	123	Brass	SV17/12

* Inner Cone 45°

Male Stud Elbow

	Connection A	HEX mm	L mm	Version	Part Number
 Tapered Thread	R 1/8, 4 x 6 mm	12		Brass	WE10/06
	R 1/4, 4 x 6 mm	12		Brass	WE13/06
	R 1/4, 6 x 8 mm	14		Brass	WE13/08

Spring Guard

	Connection A	HEX mm	L mm	Version	Part Number
 <p>completely with Tube Nut</p>	(M 10 x 1) 4 x 6 mm	12	94	Brass	KN06
	(M 12 x 1) 6 x 8 mm	14	97	Brass	KN08

Tube Nut

	Connection A	HEX mm	L mm	Version	Part Number
 <p>for Plastic Hoses</p>	(M 7 x 0,5) 3 x 4 mm		8,5	Brass	SM04
	(M 10 x 1) 4 x 6 mm	12	11	Brass	SM06
	(M 12 x 1) 6 x 8 mm	14	11	Brass	SM08



Female Tee

	Connection A	HEX mm	L mm	Version	Part Number
	G 1/8		34	Brass	TI10
	G 1/4		38,5	Brass	TI13
	G 3/8		44	Brass	TI17
	G 1/2		44	Brass	TI21
	G 3/4		50	Brass	TI26



Male Elbow

	Connection A	HEX mm	L mm	Version	Part Number
 <p>with Inner Cone</p>	G 1/8		25	Brass	WI10
	G 1/4		29	Brass	WI13
	G 3/8		35	Brass	WI17
	G 1/2		40	Brass	WI21



Female Y

	Connection A	HEX mm	L mm	Version	Part Number
 2x Female Thread 1x Male Thread con.	R 1/4 o., G 1/4 i.	17		Brass	YA13
	R 3/8 o., G 3/8 i.	20		Brass	YA17
	R 1/2 o., G 1/2 i.	25		Brass	YA21
 3x Female Thread	G 1/4	17		Brass	YI13
	G 3/8	20		Brass	YI17
	G 1/2	25		Brass	YI21

2 Way Manifold

	Connection A	HEX mm	L mm	Version	Part Number
	G 3/8 i.		47	Brass	ZO17
	G 1/2 i.		55	Brass	ZO21
 with Couplings Series 26KA	G 3/8 i.			Brass	ZM17I
	G 1/2 i.			Brass	ZM21I

3 Way Manifold

	Connection A	HEX mm	L mm	Version	Part Number
	G 3/8 i.		61	Brass	DO17
	G 1/2 i.		67	Brass	DO21
 with Couplings Series 26KA	G 3/8 i.			Brass	DM17I
	G 1/2 i.			Brass	DM21I

Manifold

	Connection A	HEX mm	L mm	Version	Part Number
	G 3/8 i.			Aluminium elox.	WD17
	G 1/2 i.			Aluminium elox.	WD21

Pressure Reducing Valve

	Connection A	HEX mm	L mm	max. Supply Pressure	Const. Supply Pressure	Version	Part Number
	G 1/4 i. x G 1/4 o.	17	34	15 bar	3,0 bar	Brass	DRV13/30
	G 1/4 i. x G 1/4 o.	17	34	15 bar	4,0 bar	Brass	DRV13/40
	G 1/4 i. x G 1/4 o.	17	34	15 bar	5,0 bar	Brass	DRV13/50
	G 1/4 i. x G 1/4 o.	17	34	15 bar	6,0 bar	Brass	DRV13/60

Swivel Joint

	Connection A	HEX mm	L mm	Version	Part Number
 swiveling	G 1/4 i. x G 1/4 o.	17	52	Steel, nickel plated	FA13A13ISPN
	G 3/8 i. x G 3/8 o.	21	58	Steel, nickel plated	FA17A17ISPN

Dust Protection

	Version	Material	Flame Resistance	Temperature Range	Color	Part Number
	universal	Thermo Flex	UL-VO	-25 up to 120°C	blue	SK12S
	universal	Euro Flex	UL-VO	-25 up to 120°C	red	SK16S
	universal	Thermo Flex	UL-VO	-25 up to 120°C	blue	SK23S
	universal	Thermo Flex	UL-VO	-25 up to 120°C	blue	SK27S
	for Coupling	PVC			red	1315-QC
	for Coupling	PVC			red	2315-QC
	for Coupling	PVC			blue	10026
	for Plug	PVC			red	1325-QC
	for Plug	PVC			red	125-QC
	for Plug	PVC			red	5026-QC

Blow-Guns

AJ13-Set in Display Box

	Connection	Extension Tube	Part Number
	Female Thread G 1/4	6 mm bent	AJ13/06SET
	Female Thread G 1/4	8 mm bent	AJ13/08SET

10x AJ13 in display box

AK13-Set in Display Box





	Connection	Extension Tube	Part Number
	Female Thread G 1/4		AK13SET

10x AK13 in display box

Blow-Guns

	Connection	Extension Tube	Part Number
 <p>made of aluminium, with standard nozzle</p>	Female Thread G 1/4		AA13
	Hose Barb 6 mm		AA06TF
	Hose Barb 9 mm		AA09TF
	Plug Series 26		AA26SF





Blow-Guns

	Connection	Extension Tube	Part Number
 <p>made of aluminium, with safety nozzle</p>	Female Thread G 1/4		AS13
	Hose Barb 6 mm		AS06TF
	Hose Barb 9 mm		AS09TF
	Plug Series 21		AS21SF
	Plug Series 26		AS26SF
 <p>made of aluminium, with sintered metal insert</p>	Female Thread G 1/4		AR13
 <p>made of aluminium, with extension tube</p>	Female Thread G 1/4		AV13
	Hose Barb 6 mm		AV06TF
	Hose Barb 9 mm		AV09TF
	Plug Series 21		AV21SF
	Plug Series 26		AV26SF
 <p>made of aluminium, with Venturi nozzle</p>	Female Thread G 1/4		AT13
	Hose Barb 6 mm		AT06TF
	Hose Barb 9 mm		AT09TF
	Plug Series 21		AT21SF
	Plug Series 26		AT26SF





Blow tap

	Connection	Extension Tube	Part Number
 <p>made of aluminium, lever operated with safety nozzle</p>	Female Thread 1/4" NPSF		ASG-1

Blow-Guns

	Connection	Extension Tube	Part Number
 <p>made of impact resistant plastic, with fixed standard nozzle, impossible to replace</p>	Female Thread G 1/4		AN13
	Hose Barb 6 mm		AN06TF
	Hose Barb 9 mm		AN09TF
	Plug Series 21		AN21SF
	Plug Series 26		AN26SF
 <p>made of impact resistant plastic, with fixed safety nozzle, impossible to replace</p>	Female Thread G 1/4		AL13
	Hose Barb 6 mm		AL06TF
	Hose Barb 9 mm		AL09TF
	Plug Series 21		AL21SF
	Plug Series 26		AL26SF
 <p>made of impact resistant plastic with sintered metal insert</p>	Female Thread G 1/4		AF13
 <p>made of impact resistant plastic with aluminium extension tube fixed nozzle, impossible to replace</p>	Female Thread G 1/4		AK13
	Hose Barb 6 mm		AK06TF
	Hose Barb 9 mm		AK09TF
	Plug Series 21		AK21SF
	Plug Series 26		AK26SF
 <p>made of impact resistant plastic extension tube brass nickel plated with a star tip nozzle - meets OSHA standards - light weight - rugged extension tube</p>	Female Thread G 1/4		AZ13
	Plug Series 26		AZ26SF

Blow-Guns

	Connection	Extension Tube	Part Number
 <p>made of impact resistant plastic, extension tube brass nickel plated - rugged extension tube</p>	Female Thread G 1/4		AC13
	Hose Barb 6 mm		AC06TF
	Hose Barb 9 mm		AC09TF
	Plug Series 21		AC21SF
	Plug Series 26		AC26SF
 <p>made of impact resistant plastic, with Venturi nozzle</p>	Female Thread G 1/4		AX13
 <p>made of impact resistant plastic, with female thread M 12 x 1,25 (without nozzle)</p>	Female Thread G 1/4		AM13
 <p>made of red impact resistant plastic, with aluminium extension tube</p>	Female Thread G 1/4	6 mm bent	AJ13/06B
	Female Thread G 1/4	8 mm straight	AJ13/08
	Female Thread G 1/4	8 mm bent	AJ13/08B
	Female Thread G 1/4	8 x 300 mm straight	AJ13-300
	Female Thread G 1/4	8 x 500 mm straight	AJ13-500
	Female Thread G 1/4	8 x 1000 mm straight	AJ13-1000

Standard Nozzle

	Connection	Extension Tube	Part Number
 <p>for blow-gun made of aluminium</p> <p>Collimated air jet, ideal for blowing out blind holes and work pieces</p>	M 12 x 1,25		KD12

Safety Nozzle

	Connection	Extension Tube	Part Number
 <p>for blow-gun made of aluminium</p> <p>With center bore and lateral annular gap. In blowing operation a protection shield against kicking chips is formed, and noise level is clearly reduced. When the center bore is held locked, air escapes through the annular gap.</p>	M 12 x 1,25		SD12

Extension Tube, 150 mm long

	Connection	Extension Tube	Part Number
 <p>for blow-gun made of aluminium</p> <p>For blowing-out deep holes and blind spots.</p>	M 12 x 1,25		VR12

Venturi-Nozzle

	Connection	Extension Tube	Part Number
 <p>Energy saving as 2/3 of environmental air is aspirated due to the Venturi principle. Wide blow-out effect due to high nozzle performance. When the center bore is held locked, air escapes through the lateral holes.</p>	M 12 x 1,25		AT12

Nozzle with sintered metal insert

	Connection	Extension Tube	Part Number
 <p>Low noise level (63-73 dB(A)), thus extremely good blowing effectivity (up to 380 l/min.)</p>	M 12 x 1,25		AR12

Blow-Gun Set

	Version	Extension Tube	Part Number
 <p>including</p> <ul style="list-style-type: none"> - Blow-Gun - Hose 6 x 8 mm, length 2,5 m - Couplings and plugs series 26 (DN 7,2) 	with Blow-Gun made of aluminium		SE26A
	with Blow-Gun made of impact resistant thermoplastic		SE26K

Hoses and tubing range

Always ideally connected.

Media

All liquid or gaseous media which flow through the hose or influence it from outside must be taken into account when choosing the hose. Chemicals can have detrimental effects (swelling, stress-cracking, etc.) on the hose materials. A prior test is therefore important. Your technical advisor will be happy to help you. For non-standard requirements, we advise you to test the hoses under operating conditions. In this way you can ensure that there are no adverse effects on the hose strength arising from extreme temperatures or chemical mixtures and the concentration thereof.

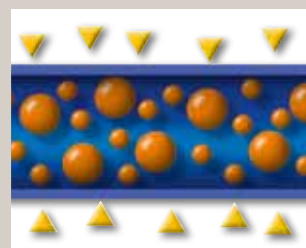

Flexibility

All thermoplastic materials are flexible up to a certain degree. Depending on the type, our hoses can therefore be used for a wide range of tasks. Ultraflexible hoses are suitable for applications with small bend radii and a high degree of movement. For example, relatively rigid or stronger tubing is the better choice for static applications with little movement but higher working pressures are required.



Flow

The flow quantity required by the attached consumer is an important criterion for hose selection. The appropriate choice of hose cross-section for the medium and flow volume is dependent on this.

As a rule of thumb: the flow rate of the hose must always be greater than the flow rate of all consumers in the circuit.



Working Pressure

From the established bursting pressure at room temperature (20°C), integration of a working pressure design factor can be calculated. For the max. working pressure, all criteria affecting the hose when in use must be observed. The most important criteria include overload through bending and stretching, and hose fatigue caused by use, as well as maintenance of extruder tolerances and production variables. Nycoil works with the highest grade polymer materials and to the latest production standards. In order to guarantee the high standard of quality, all relevant parameters and hose characteristics are checked both during and after the production process.





Working temperature

The working temperature, i.e. the temperature range in which the hose is used, is also a major factor in hose selection. A point to note is that the burst pressure – and therefore also the safe working pressure – falls significantly as temperatures rise.

Space-Saving Storage

Our straight hoses are rolled, packed on cardboard holders, and delivered in boxes – for space-saving storage and quick materials access.

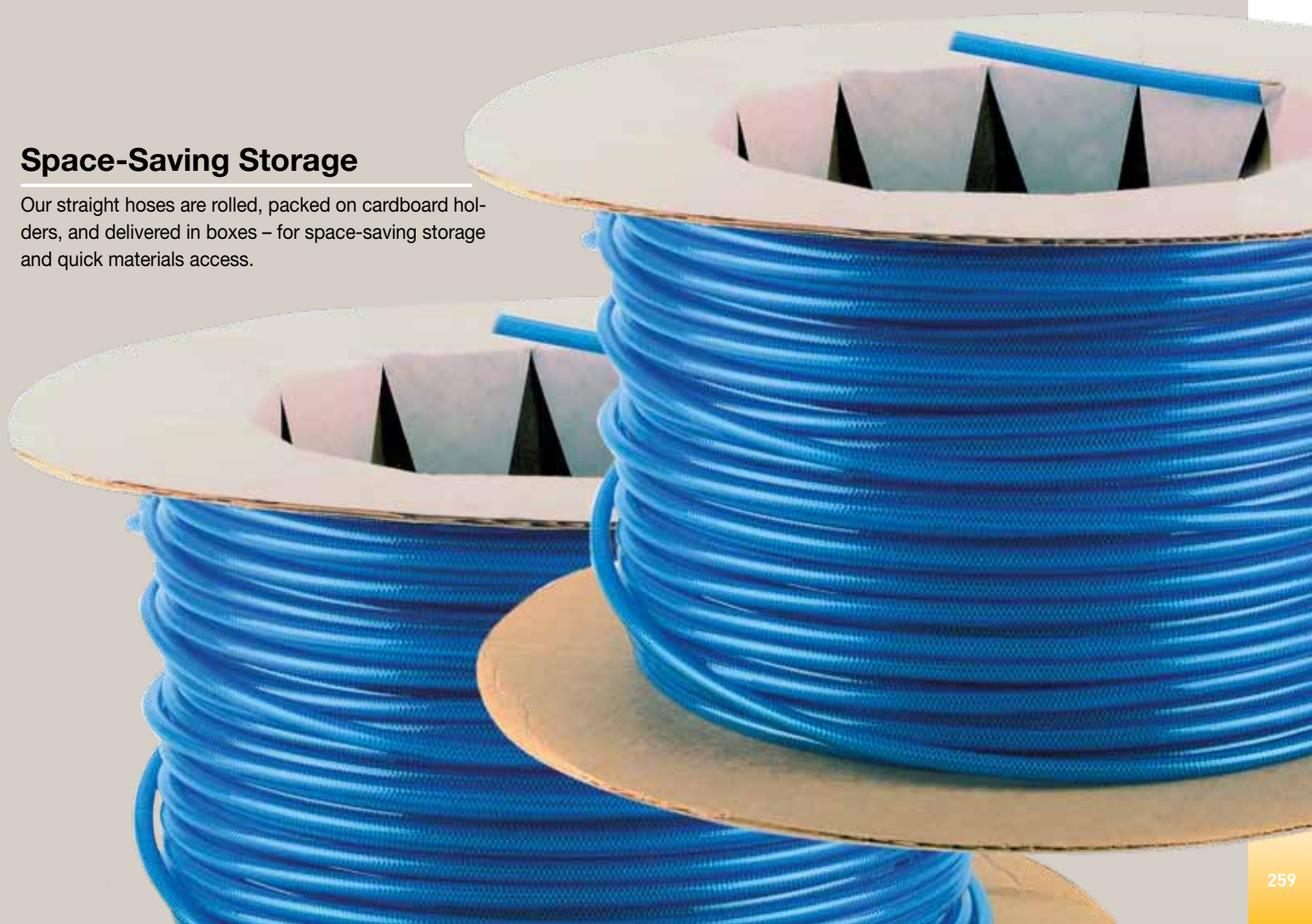

Our hose qualities at a glance.

RECTULASTIC made of Nylon 12 (Polyamid)

Straight hoses or coiled hoses; multicolored dual and quadruple; unprecedented return force; small twists and therefore requires minimum space; light weight; resistant to organic and inorganic materials.

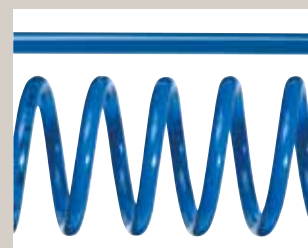

RECTUFLEX made of Polyurethan

Straight hoses or coiled hoses; multicolored dual and quadruple; extremely flexible; resistant to buckling; no change in cross-section; max. working length equal to 80% of stretch length; coiled hoses are supplied with swivel fittings and buckling protection on both ends.

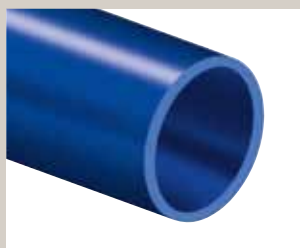

SUPERBRAID®

Polyurethan Inner Braided Hose

Straight hoses or coiled hoses; as flexible as the conventional PU hose – from -40°C to +75°C – even with fabric inlay; extremely small twist diameter; coiled hoses are supplied with pre-assembled swivel fittings and buckling protection.

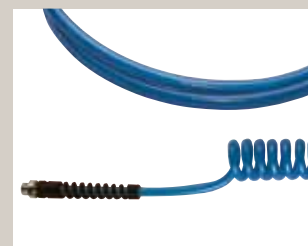
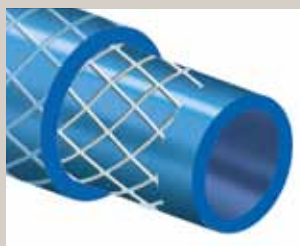

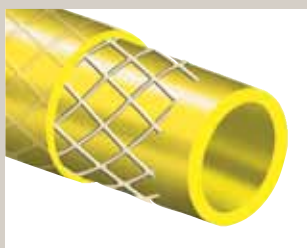

ULTRA-LITE SUPERBRAID®

Polyurethane Inner Braided Hose

Straight hoses; fittings for easy self-assembly; much lighter than the SUPERBRAID® hose and therefore even more flexible and easy to use; highly resistant to temperature (-40°C to +75°C); extremely small twist diameter.



RECTUSOFT made of highly flexible PVC, with Polyester Fibre Reinforcement (TÜV-tested)

Straight hoses or coiled hoses; extremely flexible, even at ultra-low temperatures; highly resistant to tears and pressure; light weight and easy operation makes this hose ideal for operating compressed air tools.

Fittings

Many hoses are available completely assembled with different fittings. Please check article description.





RECTULASTIC



Technical Description

RECTULASTIC hoses from Nycoil for safer, more efficient air power transmission.

Special Physical Features

- Light weight (specific weight 9x lower as copper)
- Wide temperature range
- High resistance against moisture
- Saltwater insensitive
- Long service time
- Highly elasticity

Mechanical Features

- High vibration prevention
- Perfect abrasion resistance - High compression characteristics
- Low flow reduction for all kind of media
- Precise tolerances
- Constant solidity
- Resists kinking

Applications

- Compressed air
- Lubrication grease/oil
- Gasoline
- Hydraulic
- Vacuum
- Chemicals (on request)

Advantages

- Quick assembly possible
- Straight hoses ideal for Push-In-System
- Light weight
- Low pressure drop
- Different colors for identification
- Good storage possibility due to box packing (straight hoses)
- High abrasion resistance
- Self-retracting. Coiled Hose automatically recoils to a fraction of its working length
- Small bending diameter
- Resistant to oil, gasoline, grease and abrasion

Temperature range:

-40°C up to +90°C

Maximum operating pressure:

see chart

Tubing assembled:

-20°C up to +70°C

All technical data refers to air applications. We will gladly assist you for other media.

Flow diagrams

Relation Working Pressure / Temperature

The pressure specifications apply only for the hose and not for the connection fittings.

Straight

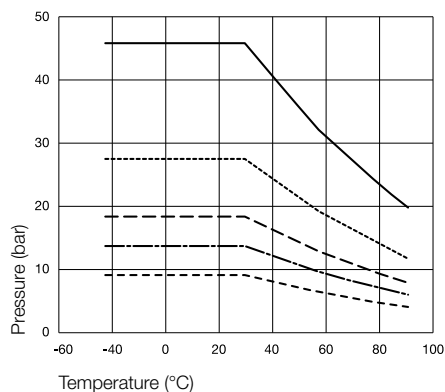

- PA040
- - - PA100
- · - PA080
- PA047, PA060
- - - - PA120, PA140

Coiled

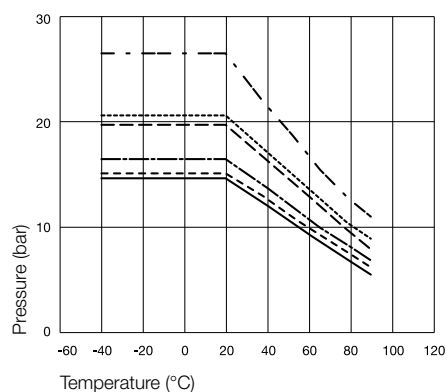

- · - - SP05
- - - SP06
- · - SP08
- SP10
- SP12
- - - - SP16

Straight Hoses

RECTULASTIC

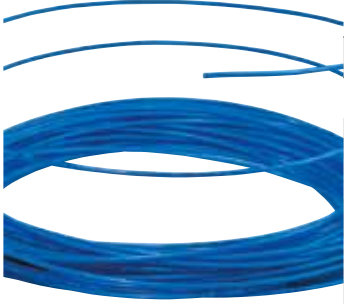
	Inside x Outside ø mm	Working Length in m	Part Number Blue*
	2,0 x 4,0	25	PA040/025/03
	4,0 x 6,0	25	PA060/025/03
	6,0 x 8,0	25	PA080/025/03
	8,0 x 10,0	25	PA100/025/03

* Hoses in black or transparent available on request.

Coiled Hoses without Fittings

RECTULASTIC

	Inside x Outside ø mm	Coil Outside Diameter mm	Max. Working Length in m	Approx. Coils	Part Number
	3,1 x 4,7	38	10	144	SP05/100
	4,8 x 6,3	75	2,5	15	SP06/025
	4,8 x 6,3	75	7,5	45	SP06/075
	4,8 x 6,3	75	22,5	140	SP06/225
	6,3 x 7,9	75	2,5	15	SP08/025
	6,3 x 7,9	75	5	30	SP08/050
	6,3 x 7,9	75	7,5	45	SP08/075
	6,3 x 7,9	75	10	60	SP08/100
	6,3 x 7,9	75	15	90	SP08/150
	6,3 x 7,9	75	22,5	135	SP08/225

Completely assembled with Swivel Fittings

RECTULASTIC



with swivel fittings
and spring guards (Type DV)

Inside x Outside ø mm	Coil Outside Diameter mm	Max. Working Length m	Approx. Coils	Part Number
3,1 x 4,7 R1/8	38	2,5	36	SP05/025/DV
3,1 x 4,7 R1/8	38	5	72	SP05/050/DV
6,3 x 7,9 R 1/4	75	2,5	15	SP08/025/DV
6,3 x 7,9 R 1/4	75	5	30	SP08/050/DV
6,3 x 7,9 R 1/4	75	7,5	45	SP08/075/DV
6,3 x 7,9 R 1/4	75	10	60	SP08/100/DV
6,3 x 7,9 R 1/4	75	15	90	SP08/150/DV
6,3 x 7,9 R 1/4	75	22,5	135	SP08/225/DV
7,9 x 9,5 R 1/4	115	2,5	10	SP10/025/DV
7,9 x 9,5 R 1/4	115	5	20	SP10/050/DV
9,5 x 11,8 R 3/8	140	5	15	SP12/050/DV
12,7 x 15,8 R 1/2	220	5	10	SP16/050/DV

Completely assembled with Coupling and Plug

RECTULASTIC



with 26 series coupling and plug
with spring guards

Inside x Outside ø mm	Coil Outside Diameter mm	Max. Working Length m	Approx. Coils	Part Number
6,3 x 7,9	75	2,5	15	SP08/025/K+S
6,3 x 7,9	75	5	30	SP08/050/K+S
6,3 x 7,9	75	7,5	45	SP08/075/K+S
6,3 x 7,9	75	10	60	SP08/100/K+S
6,3 x 7,9	75	15	90	SP08/150/K+S
7,9 x 9,5	115	5	20	SP10/050/K+S
9,5 x 11,8	140	5	15	SP12/050/K+S



RECTUFLEX



Technical Description

Nycoil polyurethane hose was developed to eliminate the two most common limitations of nylon self-storing hoses, kinking and abrasion resistance. This light-weight, yet extremely durable hose is ideal for use in tough work areas or highly mobile applications.

Special Physical Features

- Light weight (specific weight 9x lower as copper)
- Wide temperature range
- High resistance against moisture
- Saltwater insensitive
- Long service

Mechanical Features

- High vibration prevention
- Perfect abrasion resistance
- High compression characteristics
- Low flow reduction for all kind of media
- Constant solidity

Applications

- Compressed Air Lubrication grease/oil Gasoline
- Hydraulics
- Vacuum
- Chemicals (on request) Food and beverage (on request)

Advantages

- Quick assembly possible
- Light weight
- Low pressure drop
- Different colors for identification
- Good storage possibility due to box packing (straight hoses)
- High abrasion resistance
- Very small bending radius and tight coil diameter economizes on work and storage space
- Working length is 80% of total hose length
- 25 % lighter than rubber
- Specially developed swivel fittings offer lowest possible air flow restrictions
- Superior elasticity and coil memory

Working Temperature Hose:

-40°C up to +75°C

Working Temperature Hose Assembled:

-20°C up to +70°C

Maximum operating pressure:
see chart

Durometer:

95 Shore A

All technical data refers to air applications. We will gladly assist you for other media.

Flow diagrams

Relation Working Pressure / Temperature

The pressure specifications apply only for the hose and not for the connection fittings.

Straight

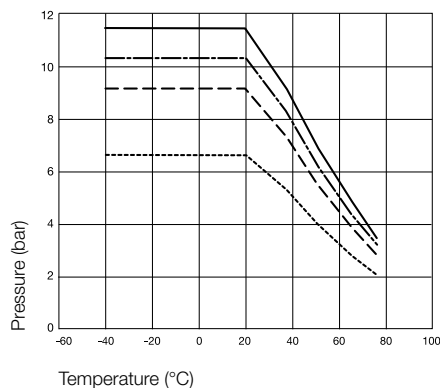

- PU040
- - - PU100
- · - PU060, MPS/06
- · · PU080, PU120, MPS/08

Coiled

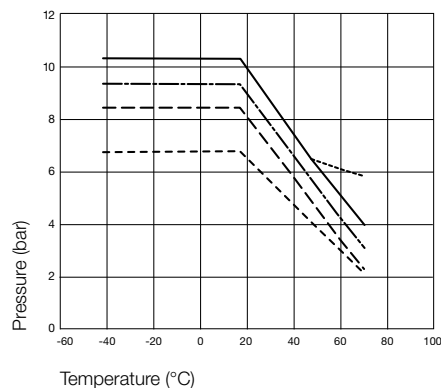

- PU10, PU19
- - - PU15, MPC06
- · - PU12
- · · PU08
- · - - MPC08



with straight extensions
508 mm and 127mm

Inside x Outside ø mm	Coil Outside Diameter mm	Working Length m	Connection	Part Number
5,0 x 8,0	40	3	G 1/4	PU08/030/DV
5,0 x 8,0	40	6	G 1/4	PU08/060/DV
5,0 x 8,0	40	7,5	G 1/4	PU08/075/DV
6,3 x 9,5	60	3	G 1/4	PU10/030/DV
6,3 x 9,5	60	6	G 1/4	PU10/060/DV
6,3 x 9,5	60	7,5	G 1/4	PU10/075/DV
8,0 x 12,0	80	3	G 3/8	PU12/030/DV
8,0 x 12,0	80	6	G 3/8	PU12/060/DV
8,0 x 12,0	80	7,5	G 3/8	PU12/075/DV



Polyurethane Inner Braided Hose

SUPERBRAID

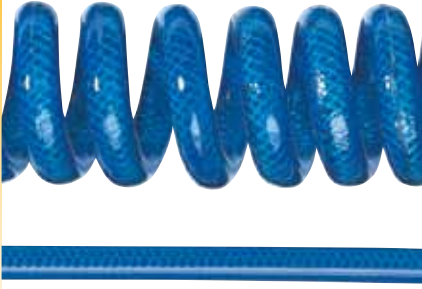

Technical Description

Superbraid polyurethane recoil hose is extruded with an inner braid for additional strength. This „integral piece“ process eliminates the need of bonding individual layers of hoses, braiding and cover which tend to separate overtime due to bending, flexing and pulsating. Superbraid combines the durability of bulkier hoses with the kink resistance and elasticity of polyurethane to make a tough, long lasting hose that is user friendly. Superbraid can be used with either our barb and sleeve fittings or reusable polyurethane fittings.

Advantages

- Same flexibility as a polyurethane hose
- Usable at 15 bar (design factor of 4 to 1)
- Flexible even at -40°C
- Highly kinking resistant; virtually undamaged by twisting or crushing
- Extremely flexible and easy to use; minimizes worker fatigue
- Superior elasticity and coil memory
- Excellent abrasion resistance;
- 6 to 10 times better than rubber or nylon
- Factory applied thread sealant supplied on male swivel fitting
- Very small bending radius and tight coil diameter economizes on work and storage space
- Both fittings nickel plated

Working Temperature:

-40°C up to +75°C

Maximum Operating Pressure:

see chart

Durometer:

85 Shore A

Color:

light blue -transparent-

All technical data refers to air applications. We will gladly assist you for other media.

Flow diagrams

Relation Working Pressure / Temperature

The pressure specifications apply only for the hose and not for the connection fittings.

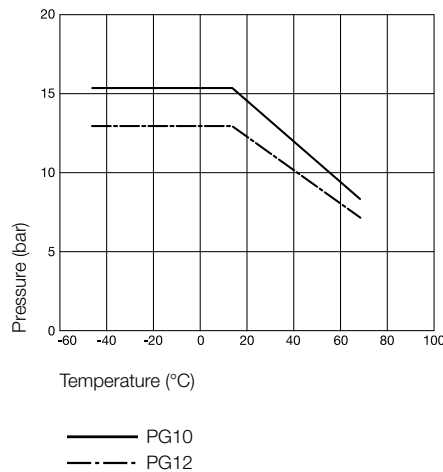

	Inside x Outside ø mm	Coil Outside Diameter mm	Working Length m	Connection	Part Number
 <p>with fabric lining</p>	6,3 x 9,5	42	3	G 1/4	PG10/030/DV
	6,3 x 9,5	42	6	G 1/4	PG10/060/DV
	6,3 x 9,5	42	7,5	G 1/4	PG10/075/DV
	7,9 x 11,7	55	3	G 3/8	PG12/030/DV
	7,9 x 11,7	55	6	G 3/8	PG12/060/DV
	7,9 x 11,7	55	7,5	G 3/8	PG12/075/DV
fully assembled with 2x nickel-plated, swivel screw connections					



Straight Hoses



Polyurethane Inner Braided Hose

ULTRA-LITE SUPERBRAID

Low Pressure



Technical Description

Thanks to the special production techniques, this hose keeps what it promises, even after frequent use and under extreme conditions. Ultra-Lite is made of polyurethane which is reinforced by a hose braid made of Dacron Polyester. Unlike conventional 3-layer textile hoses where the individual layers are not permanently bonded to each other, our Nycoil Ultra-Lite is specially made. The hose is heated and the different layers, textile and PU, melt to form a permanent bond with each other. Thanks to this process, the Ultra-Lite is extremely flexible and, above all, extremely durable. Its high level of flexibility and low weight make for easy handling. The Ultra-Lite retains its properties down to temperatures as low as -40°C.

Advantages

- Approx. 20% lighter than comparable hoses
- Further weight reduction through production of threaded couplings and hose nuts in light aluminium
- This allows us to reduce the total weight of the hose system, with all advantages of easy hose handling
- Extremely flexible even down to -40°C
- Anti-kink
- Highly temperature-resistant
- Easy do-it-yourself assembly
- of couplings, plugs or fixed screw connections from various Rectus series (available with protective sleeve on request)

Working Temperature:

-40°C up to +75°C

Maximum Operating Pressure:

see chart

Color:

yellow

All technical data refers to air applications. We will gladly assist you for other media.

Flow diagrams

Relation Working Pressure / Temperature

The pressure specifications apply only for the hose and not for the connection fittings.

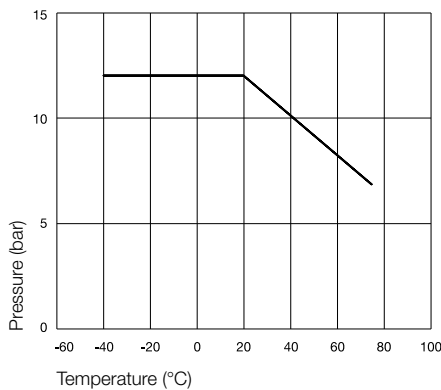

— SU13, SU17

	Inside x Outside ø mm	Working Length m	Weight g/m	Part Number
	9,5 x 13,0	25	75	SU13/025/05
	12,7 x 17,4	25	127	SU17/025/05



RECTUSOFT



Technical Description

The new generation of highly flexible Rectus hoses consists of a textile-reinforced, 3-ply PVC hose with a smooth inner tube, polyester thread insert and abrasion-proof outer covering.

Advantages

- Low weight
- Very high flexibility
- Highly resistant
- High resistance to pressure
- UV-resistant
- Long service life
- shock and tread- resistant, non-buckling
- manufacturer's imprint with technical specifications
- TÜV-certified

Working Temperature:

-15°C up to +60°C

Maximum Operating Pressure at +23°C:

15 bar

Bursting Pressure at +23°C:

63 bar

Color:

light blue

	Inside x Outside ø mm	Coil Outside Diameter mm	Package Unit	Part Number
	6,3 x 11,0	45	50	PVC06/050/03
	9,0 x 14,5	63	50	PVC09/050/03
	12,7 x 19,0	89	50	PVC12/050/03

Hose Accessories

Hose Cutter

	L	L1	Part Number
 <p>(up to outside Diameter 14 mm)</p>	79	25	RP71-00

Swivelling Spring Guard

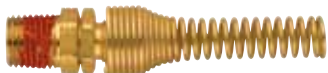
	Connection mm	HEX	Length	Version	Part Number
	R 1/8 3,1 x 4,7	11		Brass	DV10/05
	R 1/4 4,8 x 6,3	14		Brass	DV13/06
	R 1/4 6,3 x 7,9	14		Brass	DV13/08
	R 1/4 7,9 x 9,5	15		Brass	DV13/10

Fixed Spring Guard

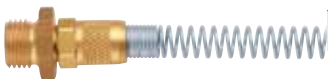
	Connection mm	HEX	Length	Version	Part Number
 <p>with spring guard * with inner cone 45°</p>	G 1/8 4,0 x 6,0	12	103	Brass	SV10/06
	G 1/8 6,0 x 8,0	12	106	Brass	SV10/08
	G 1/4 4,0 x 6,0	17	103	Brass	SV13/06
	G 1/4 6,0 x 8,0	17	106	Brass	SV13/08
	G 1/4 8,0 x 10,0	17	119	Brass	SV13/10
	G 1/4 9,0 x 12,0	17	123	Brass	SV13/12
	G 3/8 9,0 x 12,0 *	19	123	Brass	SV17/12

Worm Drive Hose Clips

	Spread mm	Height mm	Part Number
	10-16	8	KA1016
	12 - 22	8	KA1222
	16 - 27	8	KA1627
	23 - 35	9	KA2335

,O'-Clips

	Spread mm	Height mm	Part Number
	7 - 9	7	KB0709
	9 - 11	7	KB0911
	11 - 13	7	KB1113
	13 - 15	7,5	KB1315
	15 - 18	8	KB1518
	17 - 20	8,5	KB1720
	20 - 23	9	KB2023

INDEX OF CONTENTS

Coupling Systems

Series	Material	Page
02	Brass / Steel	14
1100	Brass / Steel	38
13	Brass / Steel	68
1300	Brass / Steel	64
1300	Stainless Steel	146
14	Brass / Steel	42
14	Self-Venting	222
1400	Brass / Steel	50
1400	Self-Venting	224
1600	Brass / Steel	76
1600	Self-Venting	230
1625	Brass / Steel	78
17	Brass / Steel	24
1700	Brass / Steel	90
1700	Self-Venting	232
1727	Brass / Steel	92
18	Brass / Steel	44
1800	Brass / Steel	94
1800	Stainless Steel	160
19	Brass / Steel	46
1900	Brass / Steel	112
20	Brass / Steel	18
20	Stainless Steel	132
200KL	Flat sealing	198
200KLEK	Flat sealing	196
21	Brass / Steel	26
21	Stainless Steel	140
21	Thermoplastic	176
21	Safety	210
21	Coded Systems	234
2100	Brass / Steel	128
22	Brass / Steel	48
24	Brass / Steel	52
24	Self-Venting	226
25	Brass / Steel	70
25	Stainless Steel	150
25	Safety	214
25	Coded Systems	236
26	Brass / Steel	58
26	Self-Venting	228
27	Brass / Steel	86
27	Stainless Steel	156
29	Brass / Steel	116

Series	Material	Page
30	Brass / Steel	82
303	Stainless Steel	138
33	Brass / Steel	80
34	Brass / Steel	100
37	Brass / Steel	106
38	Brass / Steel	118
39	Brass / Steel	122
40	Brass / Steel	84
41	Brass / Steel	102
42	Brass / Steel	104
48	Thermoplastic	186
50	Brass / Steel	16
52	Brass / Steel	54
57	Brass / Steel	108
70	Brass / Steel	126
70	Stainless Steel	164
70	Thermoplastic	190
95	Breathing Air	218
96	Breathing Air	220
NSA	Flat sealing	206
NSE	Flat sealing	208
NSI	Flat sealing	194
NSP	Flat sealing	204
PPL	Thermoplastic	182
PPM	Thermoplastic	172
RNS	Flat sealing	202



Accessories

Description	Page
2 Way Manifold	248
3 Way Manifold	249
90° Elbow	243
Blanking Plug	243
Blow-Guns	252
Bulkhead Lock Nut	243
Dust Protection	250
Female Stud Fitting	245
Female Tee	247
Female x Female Socket	243
Female Y	248
Fixed Spring Guard	246
Hose Repairer	240
Hose Repairer, short	240
Hose Tail Barb	239
Hose Tail Elbow, Swivelling	245
Hose Tail, long	238
Hose Tail, short	238
Male Elbow	247
Male Stud Elbow	246
Male x Male Nipple	241
Male x Male Nipple adjustable	241
Manifold Assembly	249
Pressure Reducing Valve	249
Reducing Bush, long	242
Reducing Bush, short	242
Spring Guard	247
Stud Fitting	246
Swivel Joint	249
Swivelling Spring Guard	245
Threaded Nut	238
Tube Nut	247
Washer, Aluminium	244
Washer, Fiber	244
Washer, PVC	244

Hoses and Tubing

Description	Page
Nylon 12	
RECTULASTIC	262
Polyurethane	
RECTUFLEX	266
SUPERBRAID	268
ULTRA-LITE SUPERBRAID	270
PVC	
RECTUSOFT	272
Accessories Hoses	
,O'-Clips	275
Hose Cutter	274
Worm Drive Hose Clips	275
Swivelling Spring Guard	274
Fixed Spring Guard	274

ALL OUR PERFORMANCE CAPACITY AT A GLANCE.

FLOW RATE AIR

Using this flow rate diagram, you can identify at a glance the coupling series suited to your application and the corresponding operating pressure.

Many of the series listed below are also available as a straight-through KF version.

The series highlighted in blue are our key series, which cover a broad range of applications and are available in many different designs.

- Flow KF (l/min.) – straight-through coupling systems
- Particularly suitable for pneumatic and fluid handling applications
- Flow KA (l/min.) – single shut-off coupling systems
- Particularly suitable for pneumatic applications
- Flow KB (l/min.) – double shut-off coupling systems
- Particularly suitable for fluid handling applications
- Flow KL (l/min.) – leak-free coupling systems
- Particularly suitable for fluid handling applications

The details refer to the air flow rate in litres/minute.*

*Measurement data generated in accordance with ISO 6358;
CCTOP RP50P at input pressure 6 bar, pressure drop 0.5 bar

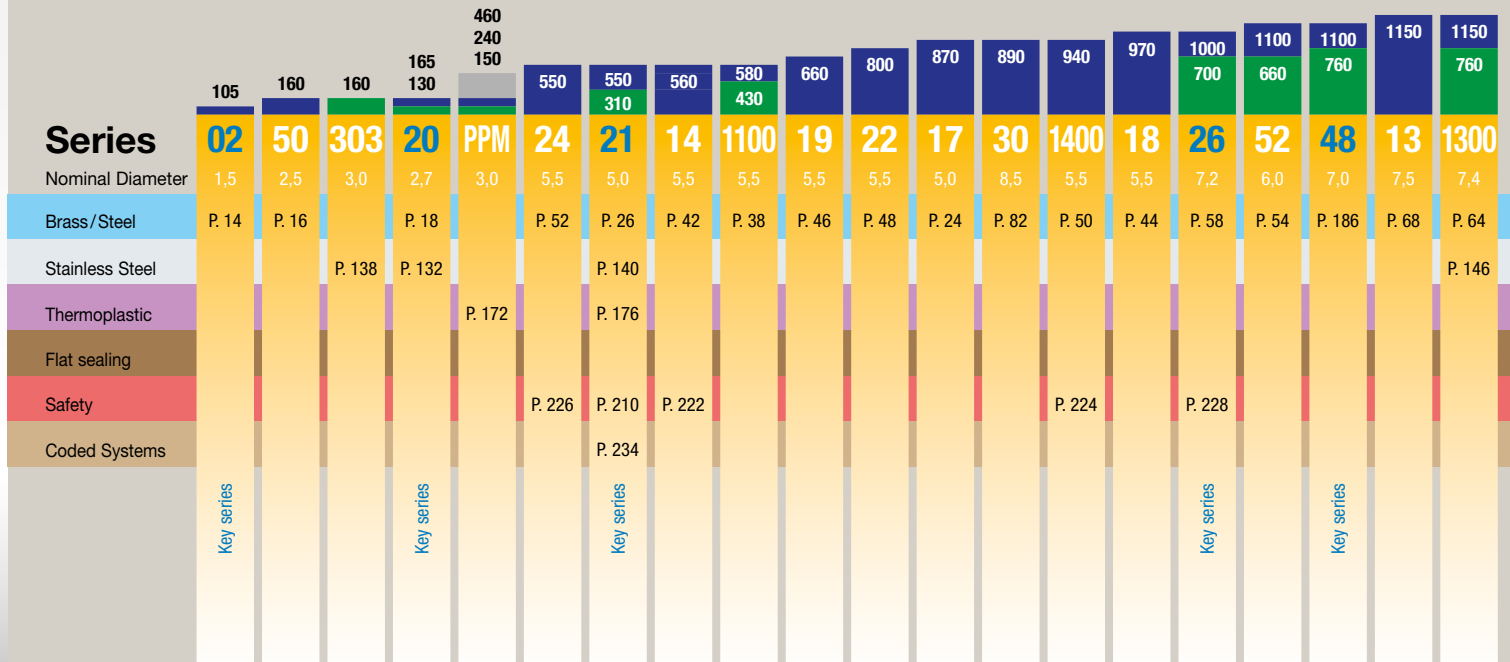

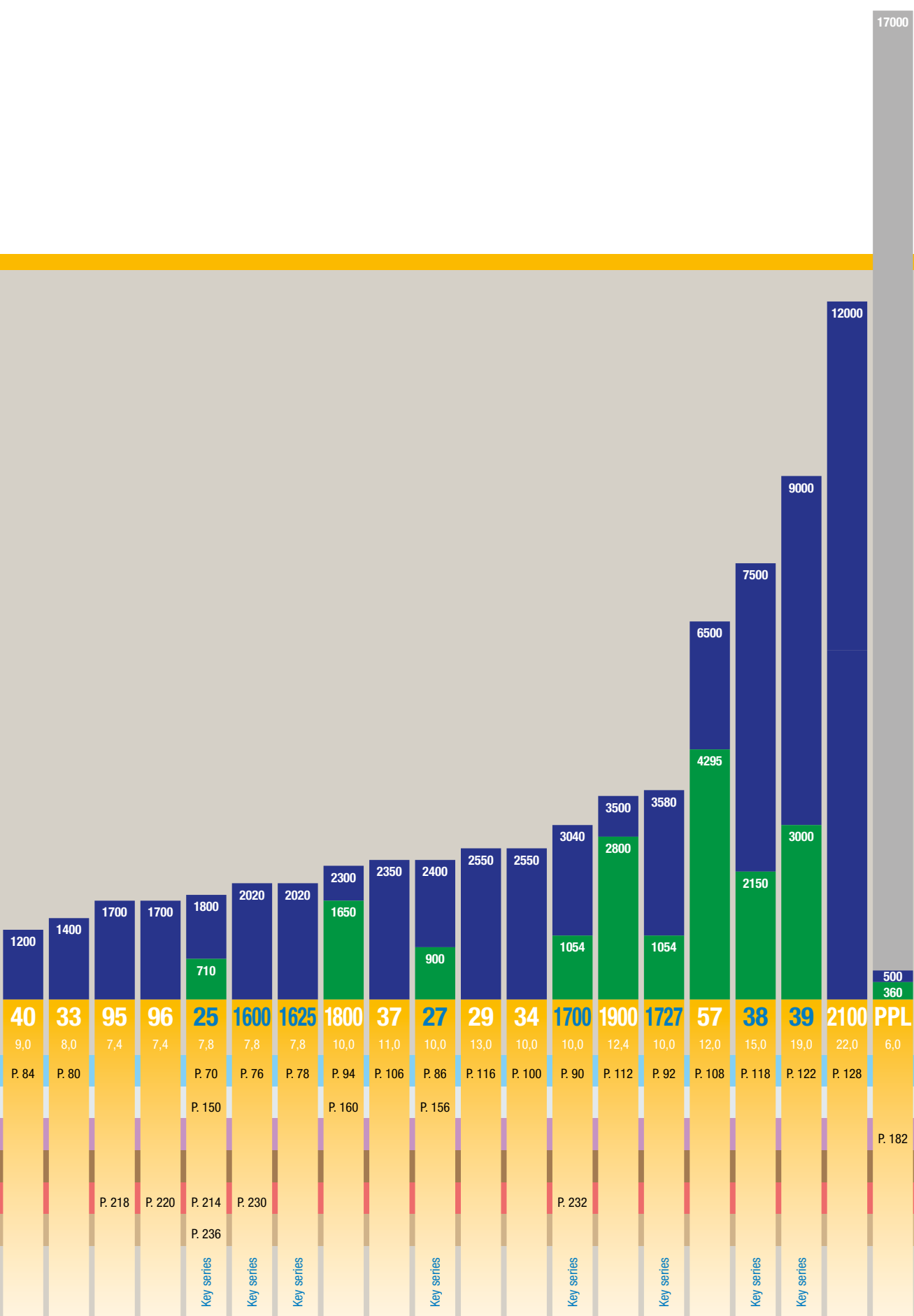

Series

- Nominal Diameter
- Brass/Steel
- Stainless Steel
- Thermoplastic
- Flat sealing
- Safety
- Coded Systems

ALL OUR PERFORMANCE CAPACITY AT A GLANCE.

FLOW RATE WATER

Using this flow rate diagram, you can identify at a glance the coupling series suited to your application and the corresponding operating pressure.

Many of the series listed below are also available as a straight-through KF version.

The series highlighted in blue are our keyseries, which cover a broad range of applications and are available in many different designs.

- Flow KF (l/min.) – straight-through coupling systems
- Particularly suitable for pneumatic and fluid handling applications
- Flow KA (l/min.) – single shut-off coupling systems
- Particularly suitable for pneumatic applications
- Flow KB (l/min.) – double shut-off coupling systems
- Particularly suitable for fluid handling applications
- Flow KL (l/min.) – leak-free coupling systems
- Particularly suitable for fluid handling applications

The details refer to the water flow rate in litres/minute.*
*(Measurement data generated in accordance with ISO 7241/2:2000, pressure drop 0.5 bar)

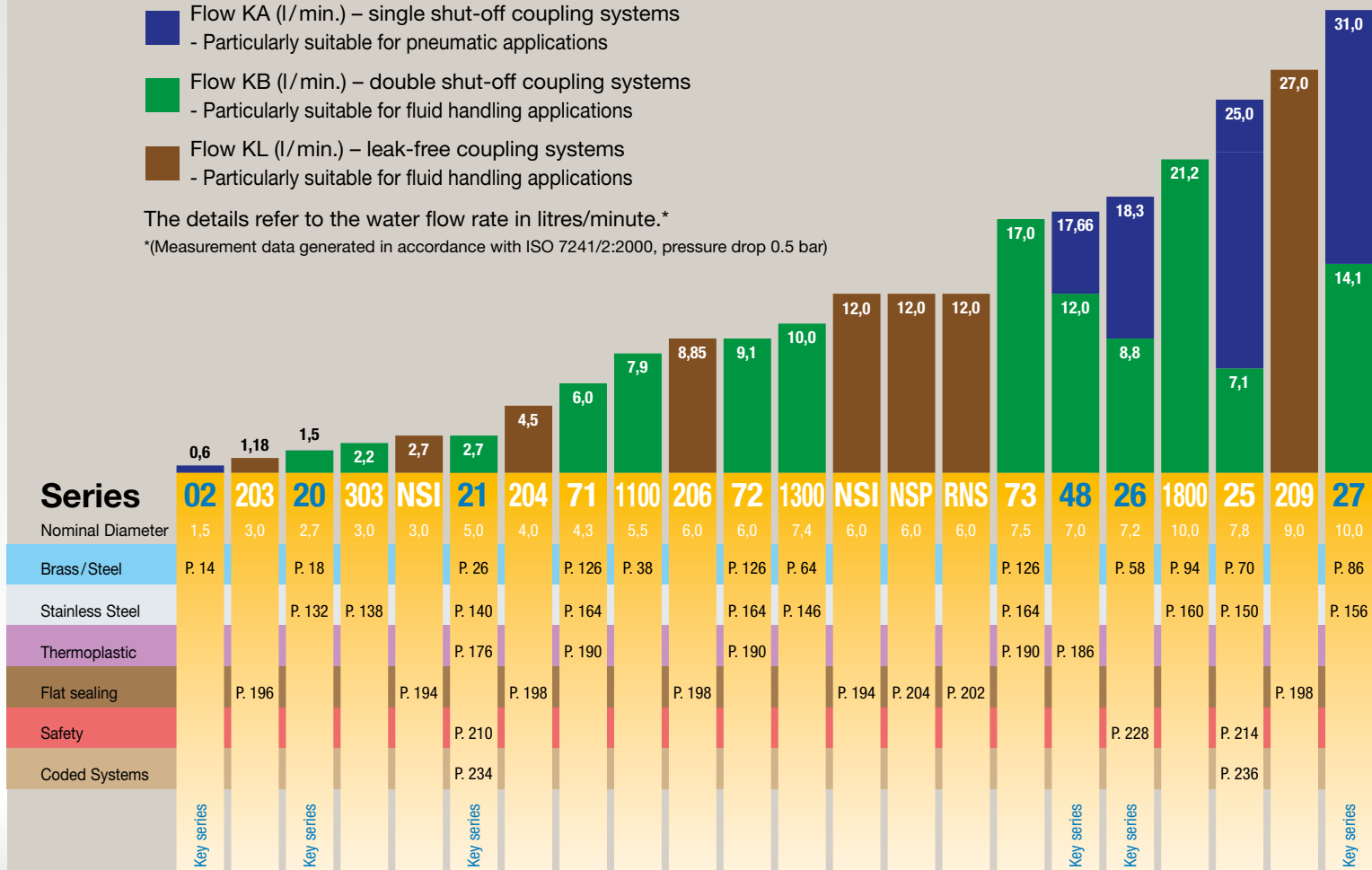

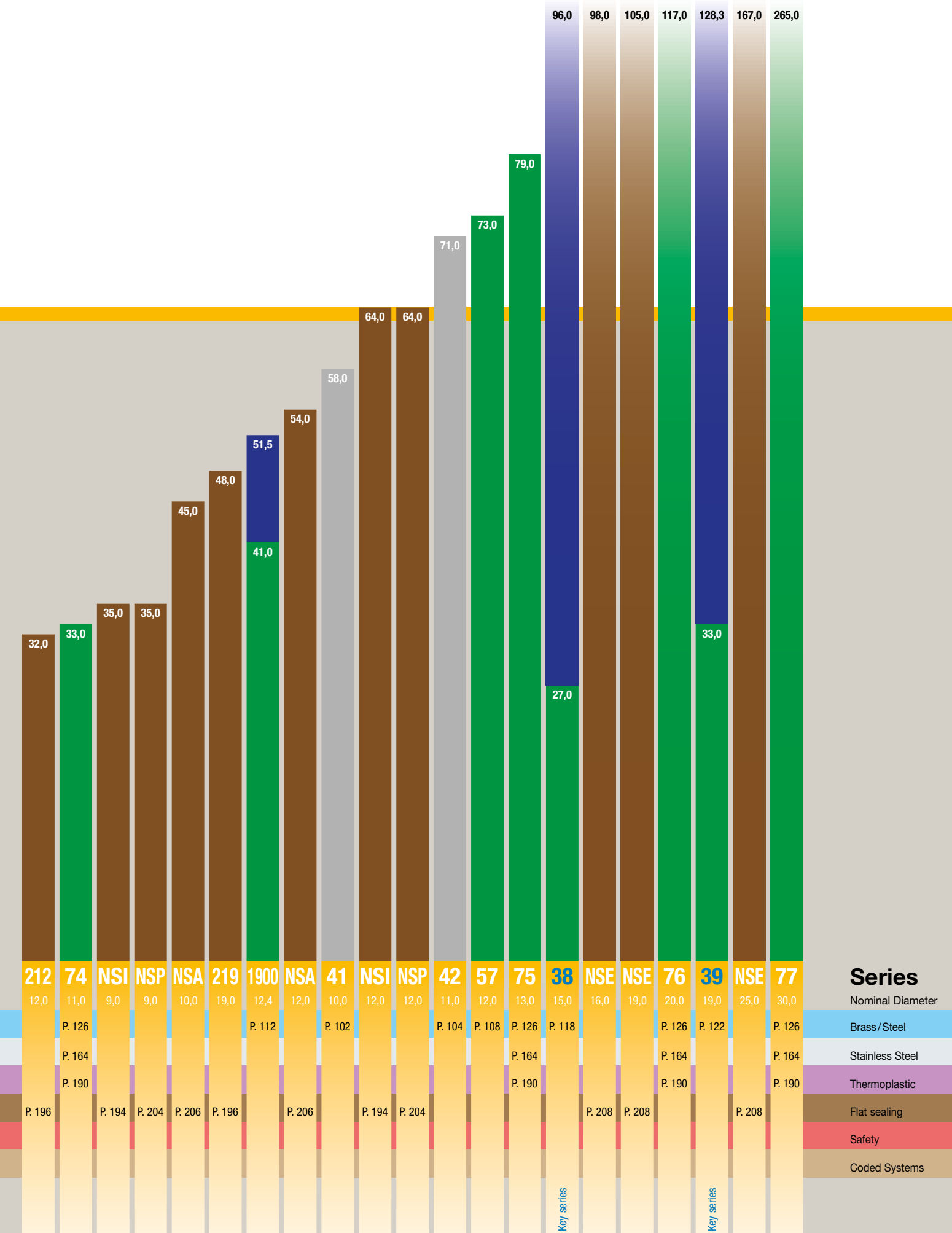

Series

Nominal Diameter
Brass/Steel
Stainless Steel
Thermoplastic
Flat sealing
Safety
Coded Systems

Key series

Key series

Notices

A series of horizontal dotted lines for writing.



Parker's Motion & Control Technologies

At Parker, we're guided by a relentless drive to help our customers become more productive and achieve higher levels of profitability by engineering the best systems for their requirements. It means looking at customer applications from many angles to find new ways to create value. Whatever the motion and control technology need, Parker has the experience, breadth of product and global reach to consistently deliver. No company knows more about motion and control technology than Parker. For further info call 00800 27 27 5374



Aerospace

Key Markets

Aftermarket services
Commercial transports
Engines
General & business aviation
Helicopters
Launch vehicles
Military aircraft
Missiles
Power generation
Regional transports
Unmanned aerial vehicles

Key Products

Control systems & actuation products
Engine systems & components
Fluid conveyance systems & components
Fluid metering, delivery & atomization devices
Fuel systems & components
Fuel tank inerting systems
Hydraulic systems & components
Thermal management
Wheels & brakes



Climate Control

Key Markets

Agriculture
Air conditioning
Construction Machinery
Food & beverage
Industrial machinery
Life sciences
Oil & gas
Precision cooling
Process
Refrigeration
Transportation

Key Products

Accumulators
Advanced actuators
CO₂ controls
Electronic controllers
Filter driers
Hand shut-off valves
Heat exchangers
Hose & fittings
Pressure regulating valves
Refrigerant distributors
Safety relief valves
Smart pumps
Solenoid valves
Thermostatic expansion valves

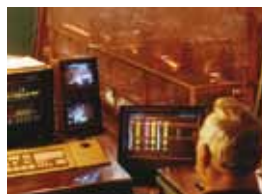

Electromechanical

Key Markets

Aerospace
Factory automation
Life science & medical
Machine tools
Packaging machinery
Paper machinery
Plastics machinery & converting
Primary metals
Semiconductor & electronics
Textile
Wire & cable

Key Products

AC/DC drives & systems
Electric actuators, gantry robots & slides
Electrohydraulic actuation systems
Electromechanical actuation systems
Human machine interface
Linear motors
Stepper motors, servo motors, drives & controls
Structural extrusions



Filtration

Key Markets

Aerospace
Food & beverage
Industrial plant & equipment
Life sciences
Marine
Mobile equipment
Oil & gas
Power generation & renewable energy
Process
Transportation
Water Purification

Key Products

Analytical gas generators
Compressed air filters & dryers
Engine air, coolant, fuel & oil filtration systems
Fluid condition monitoring systems
Hydraulic & lubrication filters
Hydrogen, nitrogen & zero air generators
Instrumentation filters
Membrane & fiber filters
Microfiltration
Sterile air filtration
Water desalination & purification filters & systems



Fluid & Gas Handling

Key Markets

Aerial lift
Agriculture
Bulk chemical handling
Construction machinery
Food & beverage
Fuel & gas delivery
Industrial machinery
Life sciences
Marine
Mining
Mobile
Oil & gas
Renewable energy
Transportation

Key Products

Check valves
Connectors for low pressure fluid conveyance
Deep sea umbilicals
Diagnostic equipment
Hose couplings
Industrial hose
Mooring systems & power cables
PTFE hose & tubing
Quick couplings
Rubber & thermoplastic hose
Tube fittings & adapters
Tubing & plastic fittings



Hydraulics

Key Markets

Aerial lift
Agriculture
Alternative energy
Construction machinery
Forestry
Industrial machinery
Machine tools
Marine
Material handling
Mining
Oil & gas
Power generation
Refuse vehicles
Renewable energy
Truck hydraulics
Turf equipment

Key Products

Accumulators
Cartridge valves
Electrohydraulic actuators
Human machine interfaces
Hybrid drives
Hydraulic cylinders
Hydraulic motors & pumps
Hydraulic systems
Hydraulic valves & controls
Hydrostatic steering
Integrated hydraulic circuits
Power take-offs
Power units
Rotary actuators
Sensors



Pneumatics

Key Markets

Aerospace
Conveyor & material handling
Factory automation
Life science & medical
Machine tools
Packaging machinery
Transportation & automotive

Key Products

Air preparation
Brass fittings & valves
Manifolds
Pneumatic accessories
Pneumatic actuators & grippers
Pneumatic valves & controls
Quick disconnects
Rotary actuators
Rubber & thermoplastic hose & couplings
Structural extrusions
Thermoplastic tubing & fittings
Vacuum generators, cups & sensors



Process Control

Key Markets

Alternative fuels
Biopharmaceuticals
Chemical & refining
Food & beverage
Marine & shipbuilding
Medical & dental
Microelectronics
Nuclear Power
Offshore oil exploration
Oil & gas
Pharmaceuticals
Power generation
Pulp & paper
Steel
Water/wastewater

Key Products

Analytical Instruments
Analytical sample conditioning products & systems
Chemical injection fittings & valves
Fluoropolymer chemical delivery fittings, valves & pumps
High purity gas delivery fittings, valves, regulators & digital flow controllers
Industrial mass flow meters/controllers
Permanent no-weld tube fittings
Precision industrial regulators & flow controllers
Process control double block & bleeds
Process control fittings, valves, regulators & manifold valves



Sealing & Shielding

Key Markets

Aerospace
Chemical processing
Consumer
Fluid power
General industrial
Information technology
Life sciences
Microelectronics
Military
Oil & gas
Power generation
Renewable energy
Telecommunications
Transportation

Key Products

Dynamic seals
Elastomeric o-rings
Electro-medical instrument design & assembly
EMI shielding
Extruded & precision-cut, fabricated elastomeric seals
High temperature metal seals
Homogeneous & inserted elastomeric shapes
Medical device fabrication & assembly
Metal & plastic retained composite seals
Shielded optical windows
Silicone tubing & extrusions
Thermal management
Vibration dampening

ENGINEERING YOUR SUCCESS.

Parker Worldwide

AE – UAE, Dubai
Tel: +971 4 8127100
parker.me@parker.com

AR – Argentina, Buenos Aires
Tel: +54 3327 44 4129

AT – Austria, Wiener Neustadt
Tel: +43 (0)2622 23501-0
parker.austria@parker.com

AT – Eastern Europe, Wiener Neustadt
Tel: +43 (0)2622 23501 900
parker.easteurope@parker.com

AU – Australia, Castle Hill
Tel: +61 (0)2-9634 7777

AZ – Azerbaijan, Baku
Tel: +994 50 2233 458
parker.azerbaijan@parker.com

BE/LU – Belgium, Nivelles
Tel: +32 (0)67 280 900
parker.belgium@parker.com

BR – Brazil, Cachoeirinha RS
Tel: +55 51 3470 9144

BY – Belarus, Minsk
Tel: +375 17 209 9399
parker.belarus@parker.com

CA – Canada, Milton, Ontario
Tel: +1 905 693 3000

CH – Switzerland, Etoy
Tel: +41 (0)21 821 87 00
parker.switzerland@parker.com

CL – Chile, Santiago
Tel: +56 2 623 1216

CN – China, Shanghai
Tel: +86 21 2899 5000

CZ – Czech Republic, Klecany
Tel: +420 284 083 111
parker.czechrepublic@parker.com

DE – Germany, Kaarst
Tel: +49 (0)2131 4016 0
parker.germany@parker.com

DK – Denmark, Ballerup
Tel: +45 43 56 04 00
parker.denmark@parker.com

ES – Spain, Madrid
Tel: +34 902 330 001
parker.spain@parker.com

FI – Finland, Vantaa
Tel: +358 (0)20 753 2500
parker.finland@parker.com

FR – France, Contamine s/Arve
Tel: +33 (0)4 50 25 80 25
parker.france@parker.com

GR – Greece, Athens
Tel: +30 210 933 6450
parker.greece@parker.com

HK – Hong Kong
Tel: +852 2428 8008

HU – Hungary, Budapest
Tel: +36 1 220 4155
parker.hungary@parker.com

IE – Ireland, Dublin
Tel: +353 (0)1 466 6370
parker.ireland@parker.com

IN – India, Mumbai
Tel: +91 22 6513 7081-85

IT – Italy, Corsico (MI)
Tel: +39 02 45 19 21
parker.italy@parker.com

JP – Japan, Tokyo
Tel: +81 (0)3 6408 3901

KR – South Korea, Seoul
Tel: +82 2 559 0400

KZ – Kazakhstan, Almaty
Tel: +7 7272 505 800
parker.easteurope@parker.com

MX – Mexico, Apodaca
Tel: +52 81 8156 6000

MY – Malaysia, Shah Alam
Tel: +60 3 7849 0800

NL – The Netherlands, Oldenzaal
Tel: +31 (0)541 585 000
parker.nl@parker.com

NO – Norway, Asker
Tel: +47 66 75 34 00
parker.norway@parker.com

NZ – New Zealand, Mt Wellington
Tel: +64 9 574 1744

PL – Poland, Warsaw
Tel: +48 (0)22 573 24 00
parker.poland@parker.com

PT – Portugal, Leca da Palmeira
Tel: +351 22 999 7360
parker.portugal@parker.com

RO – Romania, Bucharest
Tel: +40 21 252 1382
parker.romania@parker.com

RU – Russia, Moscow
Tel: +7 495 645-2156
parker.russia@parker.com

SE – Sweden, Spånga
Tel: +46 (0)8 59 79 50 00
parker.sweden@parker.com

SG – Singapore
Tel: +65 6887 6300

SK – Slovakia, Banská Bystrica
Tel: +421 484 162 252
parker.slovakia@parker.com

SL – Slovenia, Novo Mesto
Tel: +386 7 337 6650
parker.slovenia@parker.com

TH – Thailand, Bangkok
Tel: +662 717 8140

TR – Turkey, Istanbul
Tel: +90 216 4997081
parker.turkey@parker.com

TW – Taiwan, Taipei
Tel: +886 2 2298 8987

UA – Ukraine, Kiev
Tel +380 44 494 2731
parker.ukraine@parker.com

UK – United Kingdom, Warwick
Tel: +44 (0)1926 317 878
parker.uk@parker.com

US – USA, Cleveland
Tel: +1 216 896 3000

VE – Venezuela, Caracas
Tel: +58 212 238 5422

ZA – South Africa, Kempton Park
Tel: +27 (0)11 961 0700
parker.southafrica@parker.com

European Product Information Centre
Free phone: 00 800 27 27 5374
(from AT, BE, CH, CZ, DE, EE, ES, FI, FR, IE, IL, IS, IT, LU, MT, NL, NO, PT, SE, SK, UK)

**Parker Hannifin Manufacturing
Germany GmbH & Co. KG**
Quick Coupling Division Europe
Daimlerstr. 7
71735 Eberdingen – Germany
Phone +49 7042 100 0
Fax +49 7042 100 147
www.rectus.de

